

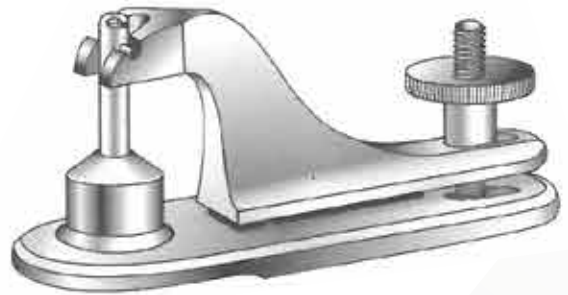



UROLOGY



 www.convertualinterlogic.com

 +234 8033200998
+234 8180003461

 enquiries@convertualinterlogic.com

 1 Anu Crescent, Off Ado-Badore Road,
Ajah, Lagos, Nigeria

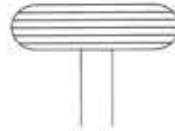

J-37-469
 23 cm / 9"



J-37-471
 23 cm / 9"

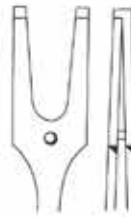

J-37-472
 24 cm / 9½"

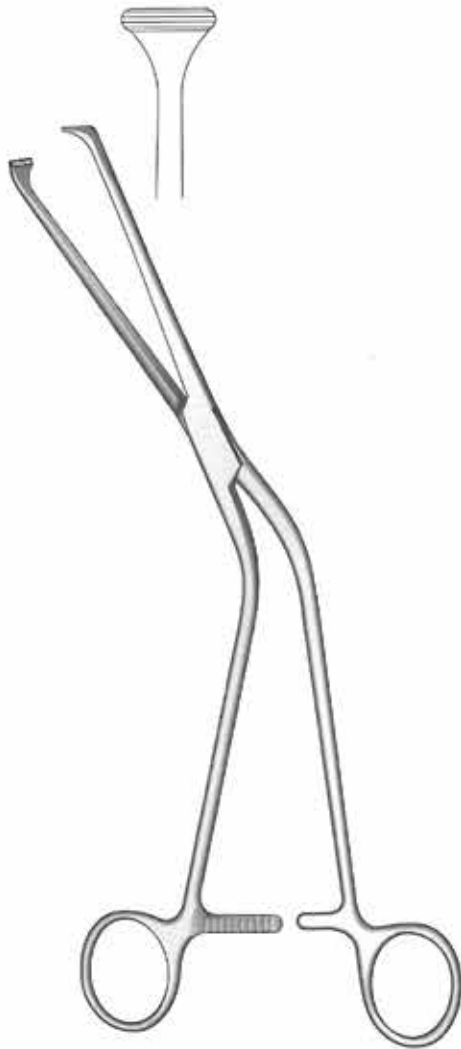

Millin
J-37-468
 24.5 cm / 9¾"

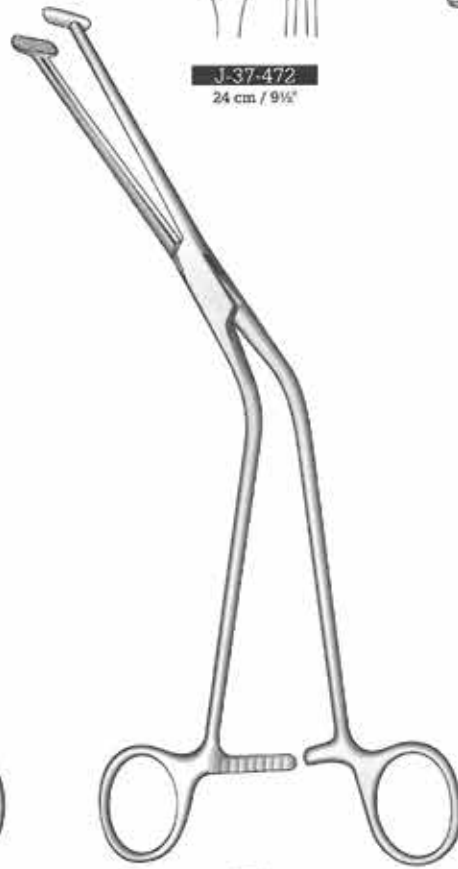

Millin

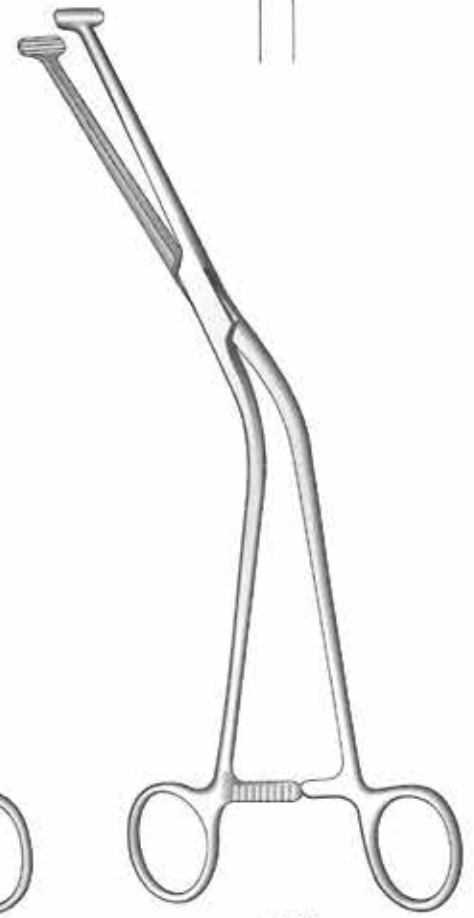

Millin
J-37-473
 23.5 cm / 9¼"

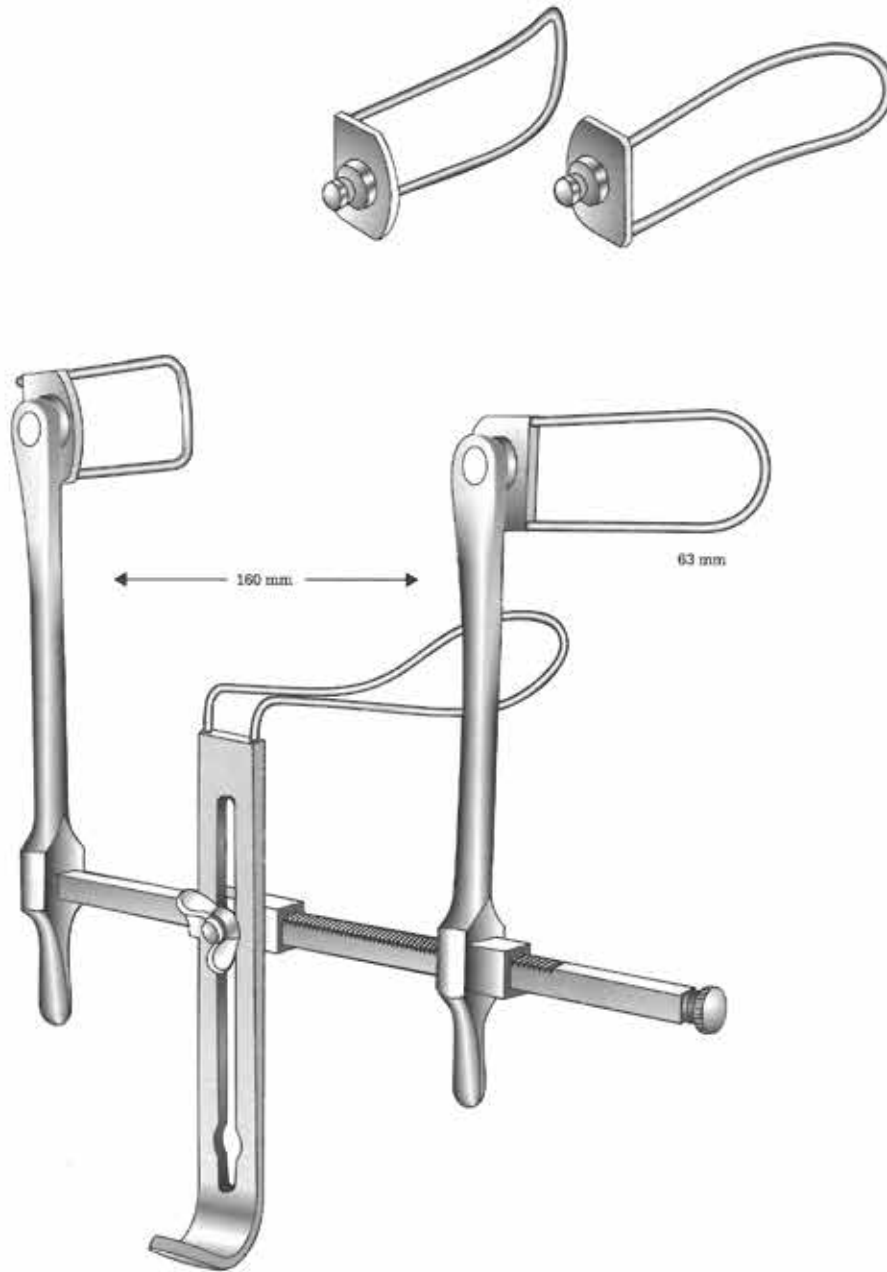

Gosset
J-38-080



Millin
J-38-130
25 cm / 9 3/4"



Millin
J-38-140
29 cm / 11 1/2"



Millin
J-38-150
25 cm / 9 3/4"

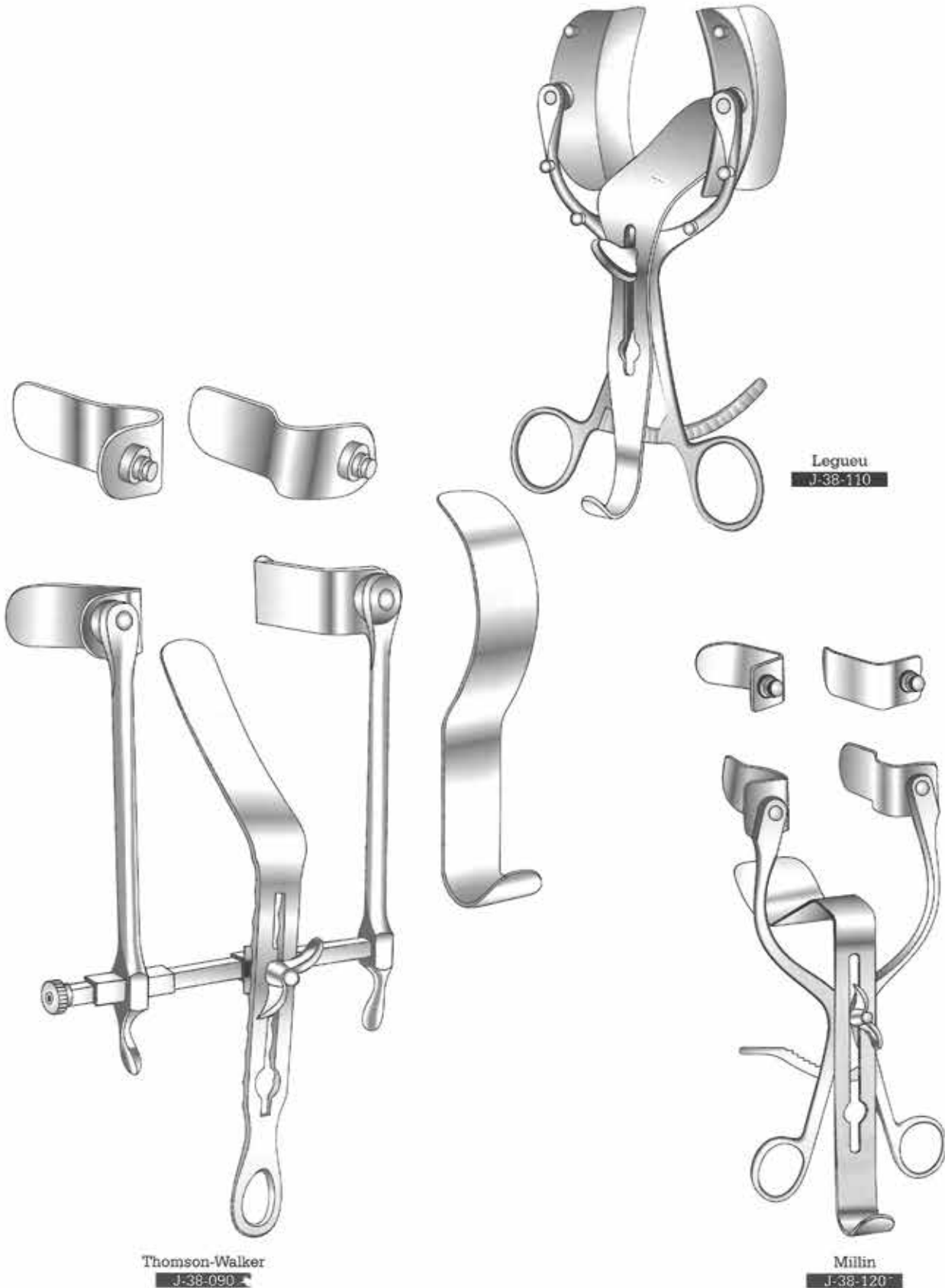



Legueu
J-38-151
27 cm / 10 5/8"

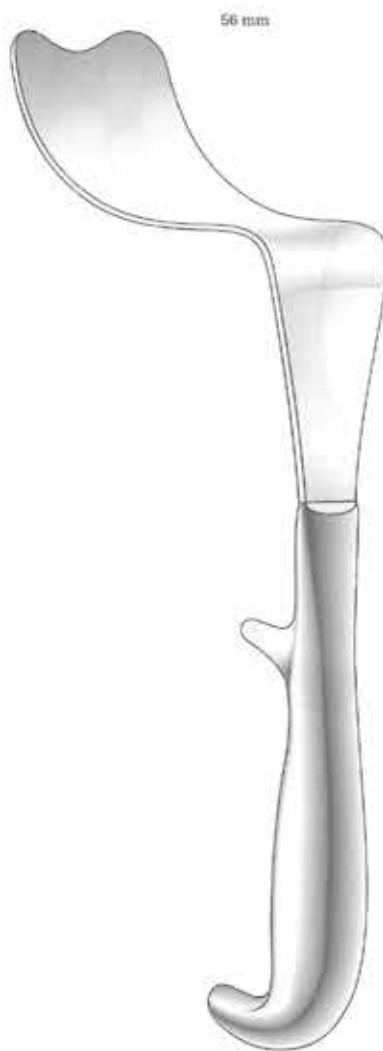

Kocher
J-38-152
26 cm / 10 1/4"



Kocher
J-38-153
26 cm / 10 1/4"

Urology

Foreign Body Forceps & Circumcision Instruments
 Fremdkörperzangen und Circumcisions-instrumentes
 Pinzas para cuerois extrabos Y circumcicion

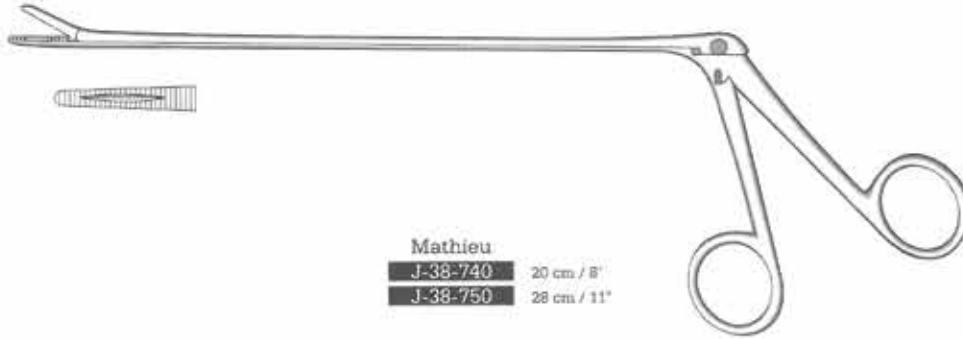

Mathieu
J-38-740 20 cm / 8"
J-38-750 28 cm / 11"

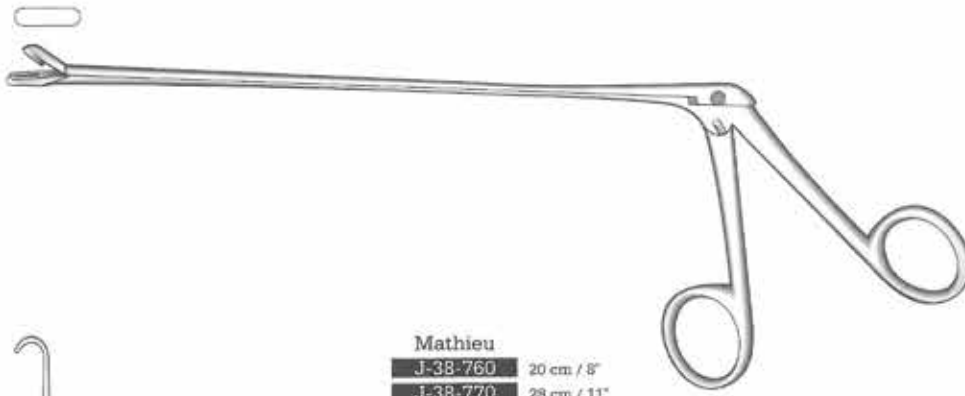

Mathieu
J-38-760 20 cm / 8"
J-38-770 28 cm / 11"



Mogen
J-38-844
 7 cm / 2 3/4"



J-38-775
 16 cm / 6 1/4"

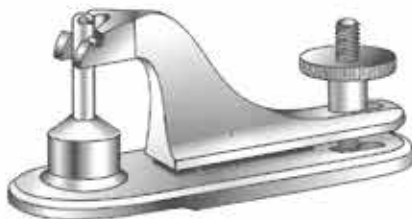

J-38-780 8 mm \varnothing
J-38-790 11 mm \varnothing
J-38-800 13 mm \varnothing
J-38-810 16 mm \varnothing
J-38-820 21 mm \varnothing
J-38-830 26 mm \varnothing
J-38-840 32 mm \varnothing



Winkelmann
J-38-841 12 mm \varnothing
J-38-842 16 mm \varnothing
J-38-843 20 mm \varnothing
 Circumcision clamps



Child
J-38-160



Key
J-38-170



Teale
J-38-180



Millin
J-38-190

Urology

Lithotomy Forceps and Penis Clamp
Steinzangen Und Penisklemmen
Pinza/litotomia y Compresores Uretrales



Lewkowitz
J-38-200
26 cm / 10 1/4"



J-38-210
Angled

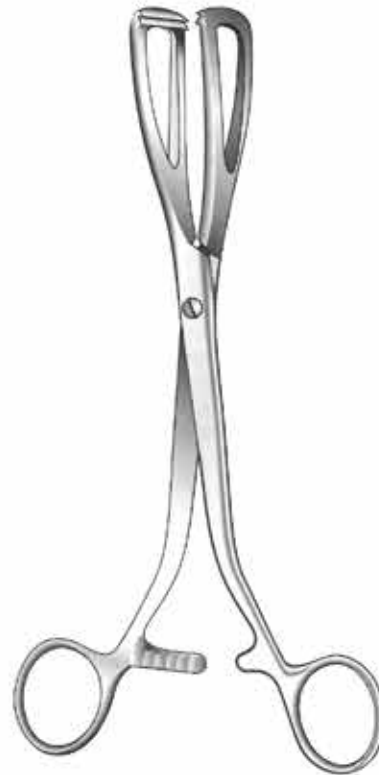

Young
J-38-211
20 cm / 8"



Thomson-Walker
J-38-220



Stockmann
J-38-221



Strauss
J-38-222



Lister
J-38-900
Set

	Fr.
J-38-910	00/1
J-38-1000	0/2
J-38-1010	1/3
J-38-1020	1/4
J-38-1030	2/5
J-38-1040	3/6
J-38-1050	4/7
J-38-1060	5/8
J-38-1070	6/9
J-38-1080	7/10
J-38-1090	8/11
J-38-1100	9/12
J-38-1110	10/13
J-38-1120	11/14
J-38-1130	12/15
J-38-1140	13/16
J-38-1150	14/17
J-38-1160	15/18



Clutton
J-38-920
Set

	Fr.
J-38-930	6/10
J-38-940	8/12
J-38-950	10/14
J-38-960	12/16
J-38-970	14/18
J-38-980	16/20
J-38-990	18/22
J-38-1180	20/24
J-38-1190	22/26
J-38-1200	24/28
J-38-1210	26/30
J-38-1220	28/32



	Fr.
J-38-850	06
J-38-860	08
J-38-870	10
J-38-880	12



Dittel
J-38-890
Set

	Fr.
J-38-1900	8
J-38-1901	9
J-38-1902	10
J-38-1903	11
J-38-1904	12
J-38-1905	13
J-38-1906	14
J-38-1907	15
J-38-1908	16
J-38-1909	17
J-38-1910	18
J-38-1911	19
J-38-1912	20
J-38-1913	21
J-38-1914	22
J-38-1915	23
J-38-1916	24
J-38-1917	25
J-38-1918	26
J-38-1919	27
J-38-1920	28
J-38-1921	29
J-38-1922	30



Ven Buren
J-38-1250
Set

	Fr.
J-38-1221	8
J-38-1222	9
J-38-1223	10
J-38-1224	11
J-38-1225	12
J-38-1226	13
J-38-1227	14
J-38-1228	15
J-38-1229	16
J-38-1230	17
J-38-1231	18
J-38-1232	19
J-38-1233	20
J-38-1234	21
J-38-1235	22
J-38-1236	23
J-38-1237	24
J-38-1238	25
J-38-1239	26
J-38-1240	27
J-38-1241	28
J-38-1242	29
J-38-1243	30
J-38-1244	32
J-38-1245	34
J-38-1246	36

Urology

Dilating Bougies
Dilatationsbougies
Bugiasdilator

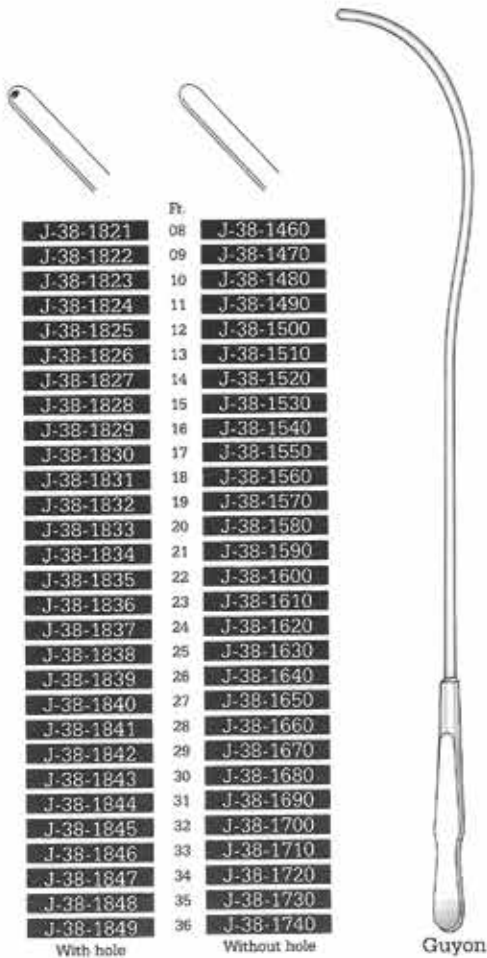

	Fr.	
J-38-1821	08	J-38-1460
J-38-1822	09	J-38-1470
J-38-1823	10	J-38-1480
J-38-1824	11	J-38-1490
J-38-1825	12	J-38-1500
J-38-1826	13	J-38-1510
J-38-1827	14	J-38-1520
J-38-1828	15	J-38-1530
J-38-1829	16	J-38-1540
J-38-1830	17	J-38-1550
J-38-1831	18	J-38-1560
J-38-1832	19	J-38-1570
J-38-1833	20	J-38-1580
J-38-1834	21	J-38-1590
J-38-1835	22	J-38-1600
J-38-1836	23	J-38-1610
J-38-1837	24	J-38-1620
J-38-1838	25	J-38-1630
J-38-1839	26	J-38-1640
J-38-1840	27	J-38-1650
J-38-1841	28	J-38-1660
J-38-1842	29	J-38-1670
J-38-1843	30	J-38-1680
J-38-1844	31	J-38-1690
J-38-1845	32	J-38-1700
J-38-1846	33	J-38-1710
J-38-1847	34	J-38-1720
J-38-1848	35	J-38-1730
J-38-1849	36	J-38-1740

With hole Without hole

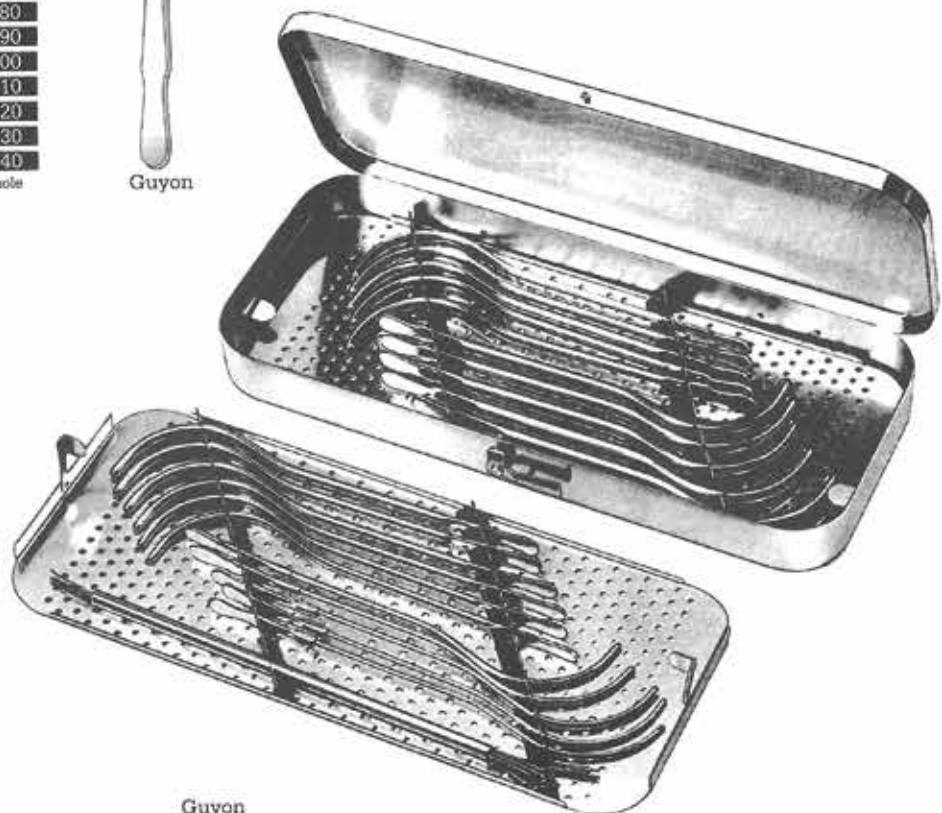

Guyon

J-38-1450	Set of 29 with hole, Fr. 8 - Fr. 36
J-38-1451	Set of 29 without hole, Fr. 8 - Fr. 36



Male

- J-38-230 Fig. 06
- J-38-235 Fig. 07
- J-38-240 Fig. 08
- J-38-245 Fig. 09
- J-38-250 Fig. 10
- J-38-255 Fig. 11
- J-38-260 Fig. 12
- J-38-265 Fig. 13
- J-38-270 Fig. 14
- J-38-275 Fig. 15
- J-38-280 Fig. 16
- J-38-285 Fig. 17
- J-38-290 Fig. 18
- J-38-295 Fig. 19
- J-38-300 Fig. 20
- J-38-305 Fig. 21
- J-38-310 Fig. 22
- J-38-315 Fig. 23
- J-38-320 Fig. 24

27 cm / 10½"



Coxeter

- J-38-430 Fig. 06
- J-38-435 Fig. 07
- J-38-440 Fig. 08
- J-38-445 Fig. 09
- J-38-450 Fig. 10
- J-38-455 Fig. 11
- J-38-460 Fig. 12
- J-38-465 Fig. 13
- J-38-470 Fig. 14
- J-38-475 Fig. 15
- J-38-480 Fig. 16
- J-38-485 Fig. 17
- J-38-490 Fig. 18
- J-38-495 Fig. 19
- J-38-500 Fig. 20
- J-38-505 Fig. 21
- J-38-510 Fig. 22
- J-38-515 Fig. 23
- J-38-520 Fig. 24

28 cm / 11"



Female

- J-38-530 Fig. 06
- J-38-535 Fig. 07
- J-38-540 Fig. 08
- J-38-545 Fig. 09
- J-38-550 Fig. 10
- J-38-555 Fig. 11
- J-38-560 Fig. 12
- J-38-565 Fig. 13
- J-38-570 Fig. 14
- J-38-575 Fig. 15
- J-38-580 Fig. 16
- J-38-585 Fig. 17
- J-38-590 Fig. 18
- J-38-595 Fig. 19
- J-38-600 Fig. 20
- J-38-605 Fig. 21
- J-38-610 Fig. 22
- J-38-615 Fig. 23
- J-38-620 Fig. 24

15 cm / 6"



Female

- J-38-630 Fig. 06
- J-38-635 Fig. 07
- J-38-640 Fig. 08
- J-38-645 Fig. 09
- J-38-650 Fig. 10
- J-38-655 Fig. 11
- J-38-660 Fig. 12
- J-38-665 Fig. 13
- J-38-670 Fig. 14
- J-38-675 Fig. 15
- J-38-680 Fig. 16
- J-38-685 Fig. 17
- J-38-690 Fig. 18
- J-38-695 Fig. 19
- J-38-700 Fig. 20
- J-38-705 Fig. 21
- J-38-710 Fig. 22
- J-38-715 Fig. 23
- J-38-720 Fig. 24

20 cm / 8"

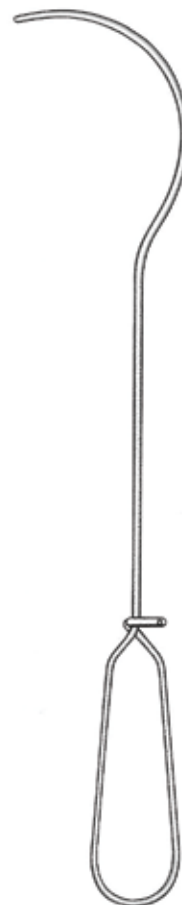

J-38-731

35 cm / 13¾"



Guyon

J-38-730

39 cm / 15½"