





# ***RIB SHEARS & CARDIOVASCULAR SURGERY***



 [www.convertualinterlogic.com](http://www.convertualinterlogic.com)

 +234 8033200998  
+234 8180003461

 [enquiries@convertualinterlogic.com](mailto:enquiries@convertualinterlogic.com)

 1 Anu Crescent, Off Ado-Badore Road,  
Ajah, Lagos, Nigeria

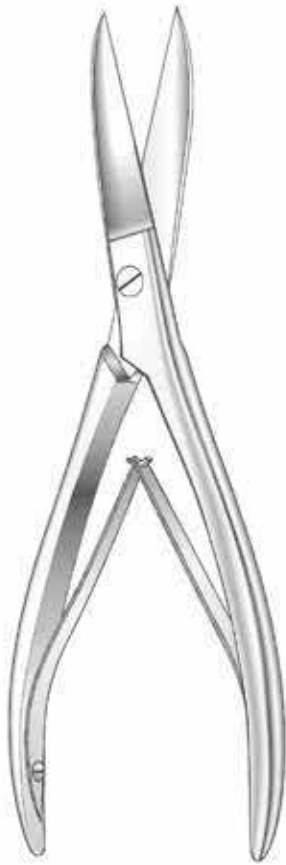

J-28-001 20 cm / 8"  
 J-28-010 23 cm / 9"

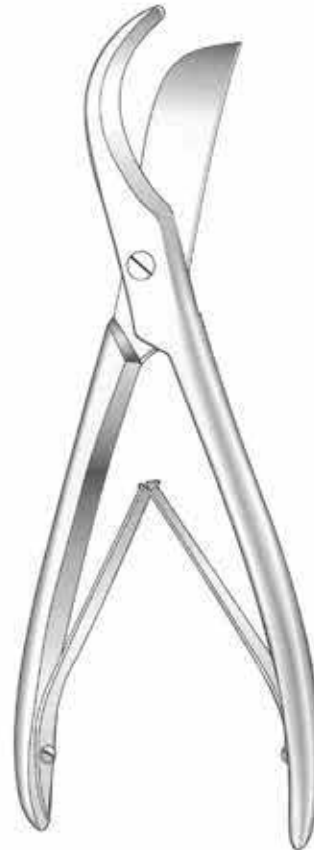

J-28-020  
 22 cm / 8 1/2"

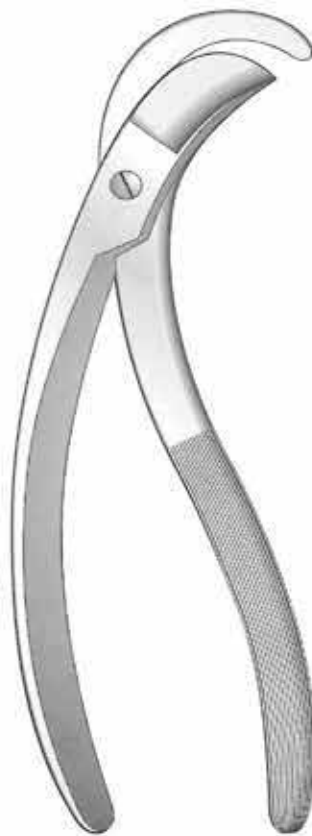

J-28-030  
 19 cm / 7 1/2"



Gluck  
 J-28-040 19 cm / 7 1/2"  
 J-28-050 22 cm / 8 1/2"  
 Drawing cut

# Rib Shears

Bone and Rib Shears

Knochen-und rippenscheren

Cizallas para huesos y costillas



Coryllos Bethune (Collin)

J-28-361 24 cm / 9 1/4"

J-28-363

J-28-362 30 cm / 12"

J-28-364

For right hand

For left hand

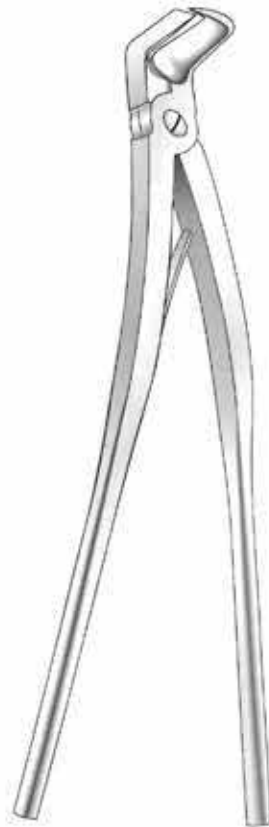

Roos

J-28-365

33 cm / 13 1/8"



Stille

J-28-368

21 cm / 8 1/4"

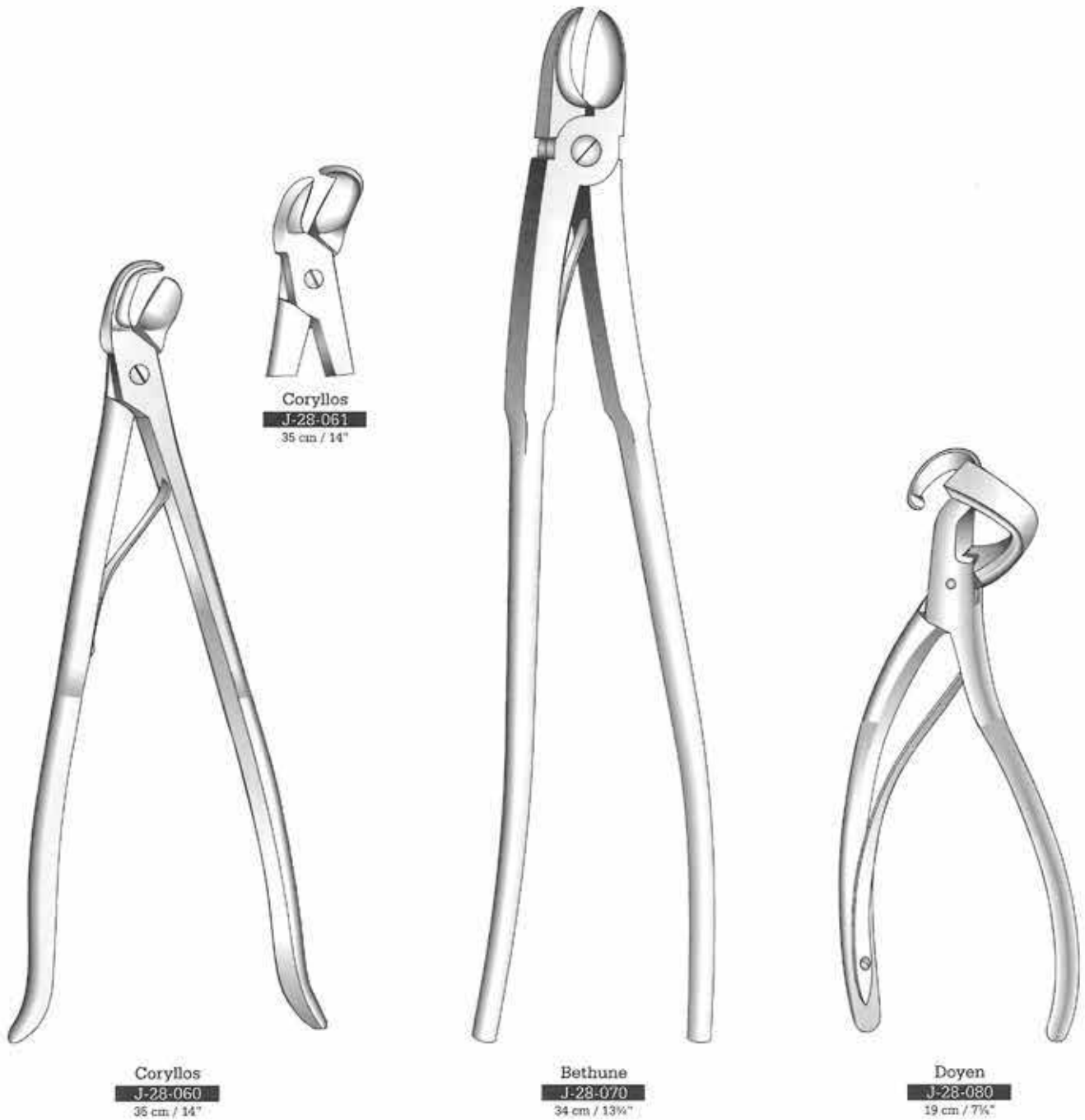

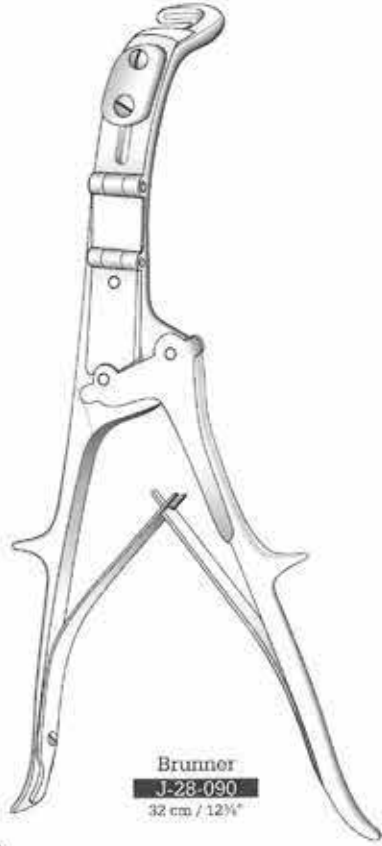

**Brunner**  
**J-28-090**  
32 cm / 12 5/8"



**Sauerbruch-Frey**  
**J-28-100**  
36 cm / 14 1/4"

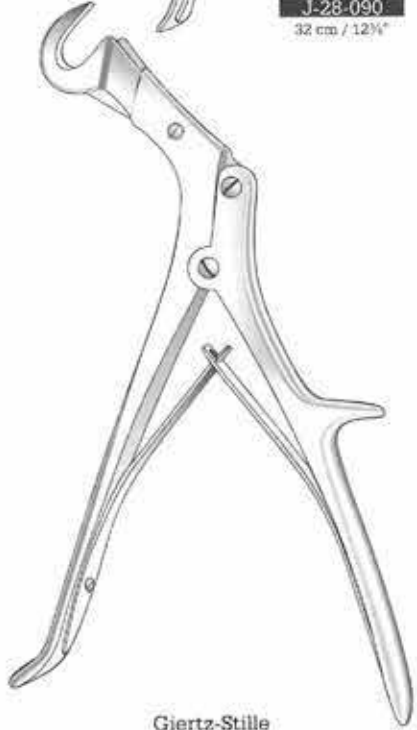

**Giertz-Stille**  
**J-28-110**  
27 cm / 10 5/8"

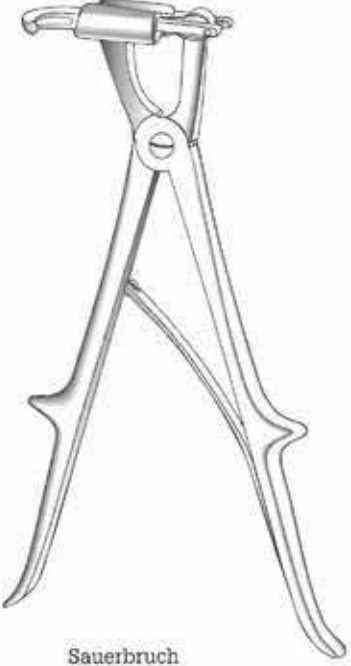

**Sauerbruch**  
**J-28-111** 24 cm / 9 1/2"  
**J-28-112** 27 cm / 10 5/8"  
For adults

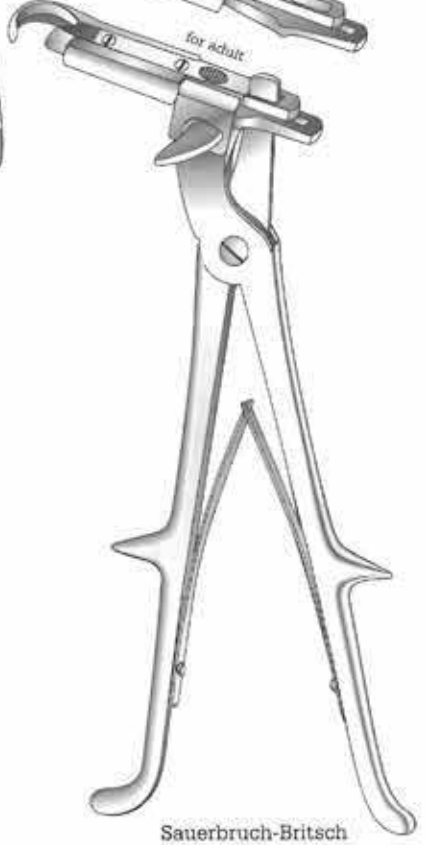

**Sauerbruch-Britsch**  
**J-28-113**  
30 cm / 12"  
with 2 exchangeable cutter head

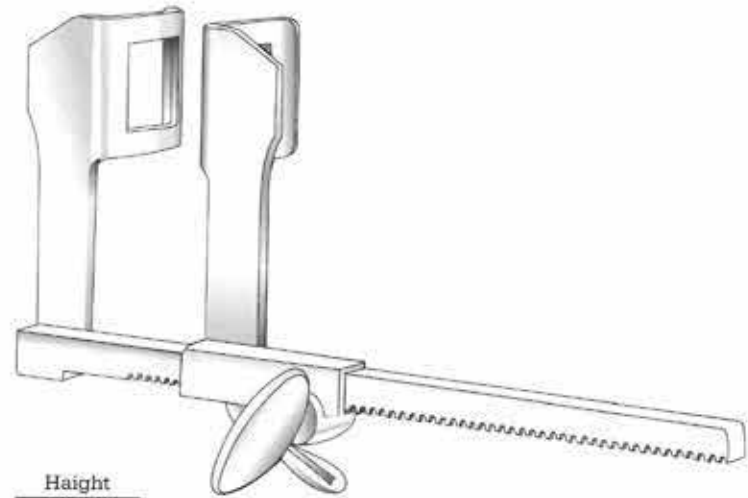
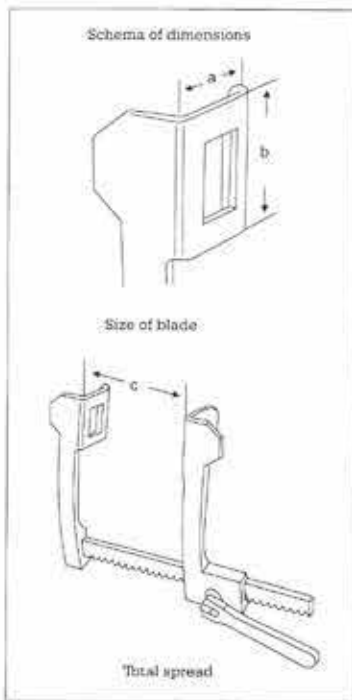

**Haight**  
**J-28-150**  
 a=30; b=30; c=90 mm

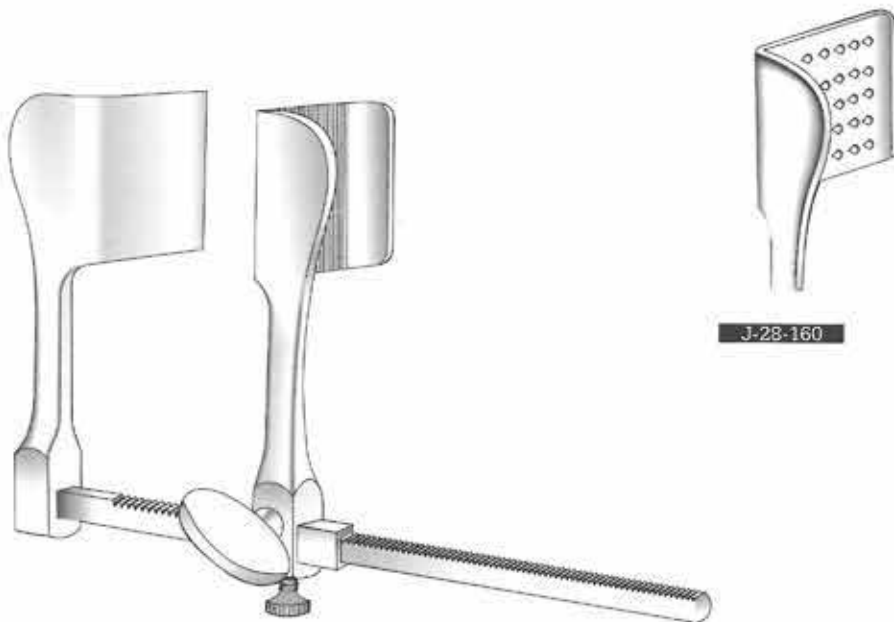

**Tuffier**  
**J-28-161**  
 a=50; b=45; c=165 mm

**J-28-160**

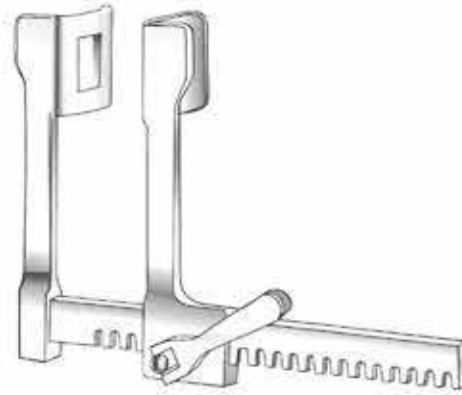
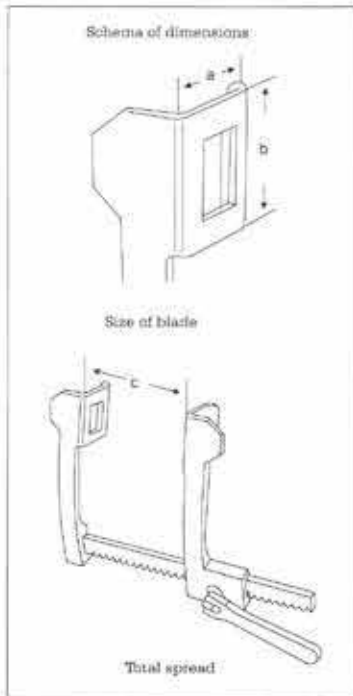

**Finochietto-Baby**  
**J-28-170**  
a=18; b=20; c=75 mm

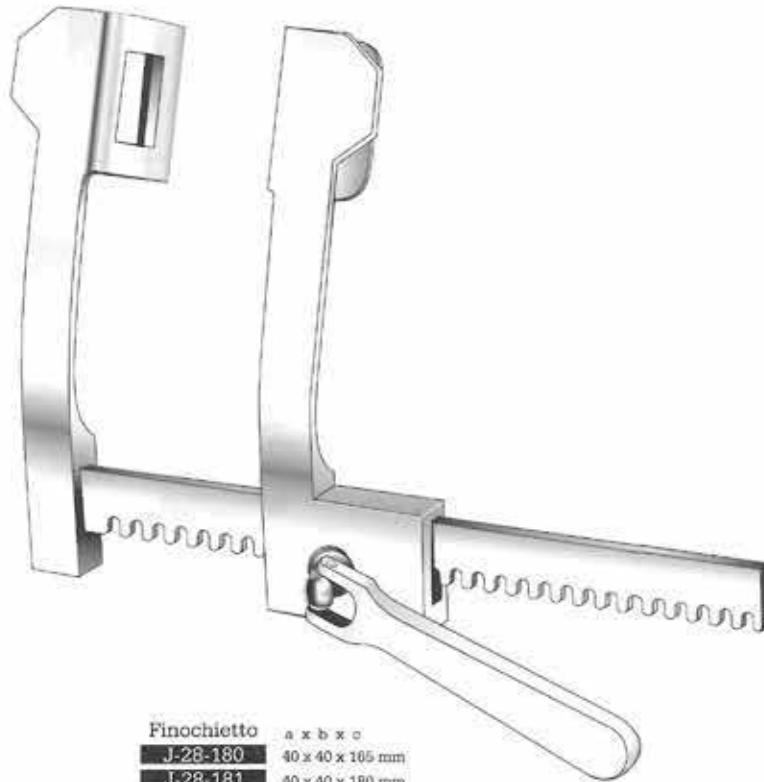

Finochietto	a x b x c
<b>J-28-180</b>	40 x 40 x 165 mm
<b>J-28-181</b>	40 x 40 x 180 mm
<b>J-28-190</b>	45 x 45 x 200 mm
<b>J-28-200</b>	70 x 65 x 250 mm



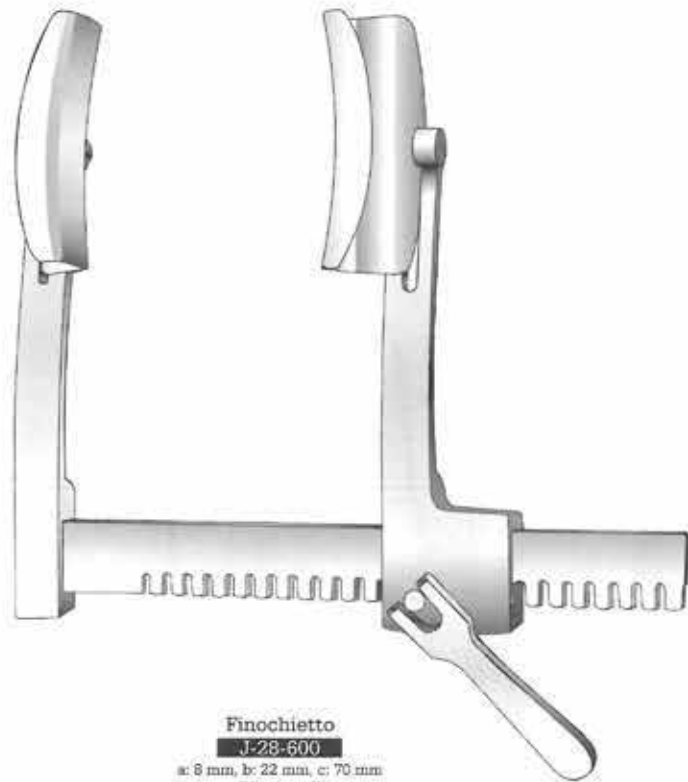
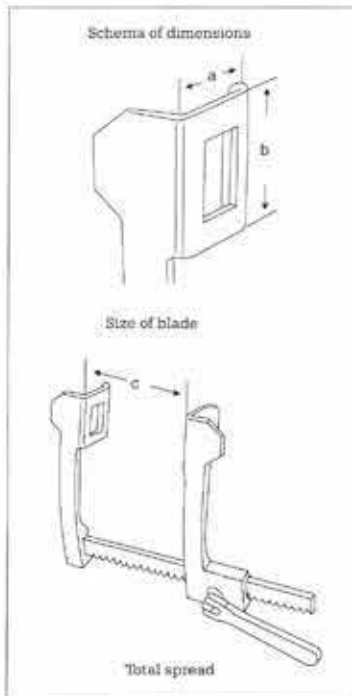

**Finochietto**  
**J-28-600**

a: 8 mm, b: 22 mm, c: 70 mm  
 Extra small  
 Movable blades

**J-28-601**

a: 13 mm, b: 33 mm, c: 90 mm  
 For infants  
 Movable blades

**J-28-602**

a: 15 mm, b: 50 mm, c: 90 mm  
 For pediatric  
 Movable blades



**Rib Shears**  
**Rib Spreader**  
**Rippensperrer**  
**Separadores costales**

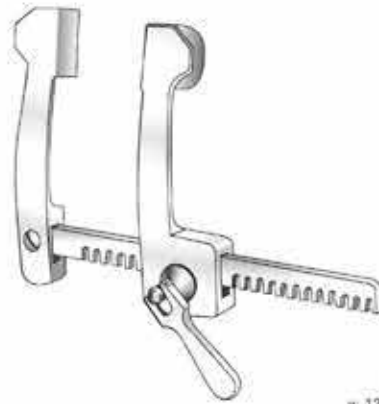
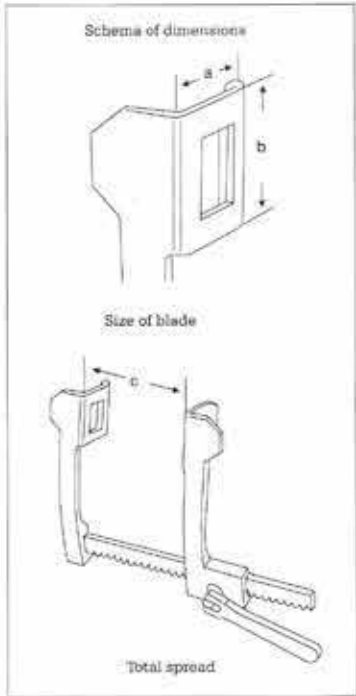

Cooley  
**J-28-615**  
a: 12 mm, b: 16 mm, c: 95 mm  
For new born

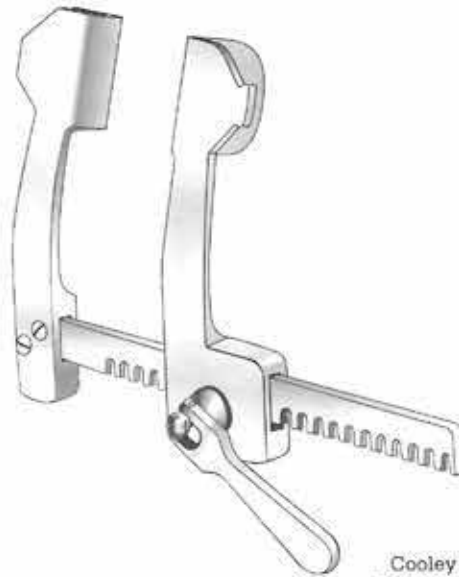

Cooley	a	b	c
<b>J-28-620</b>	15 mm	30 mm	140 mm
<b>J-28-625</b>	21 mm	44 mm	150 mm

Pediatric size



Cooley  
**J-28-630**  
a: 35 mm, b: 50 mm, c: 200 mm  
For adults

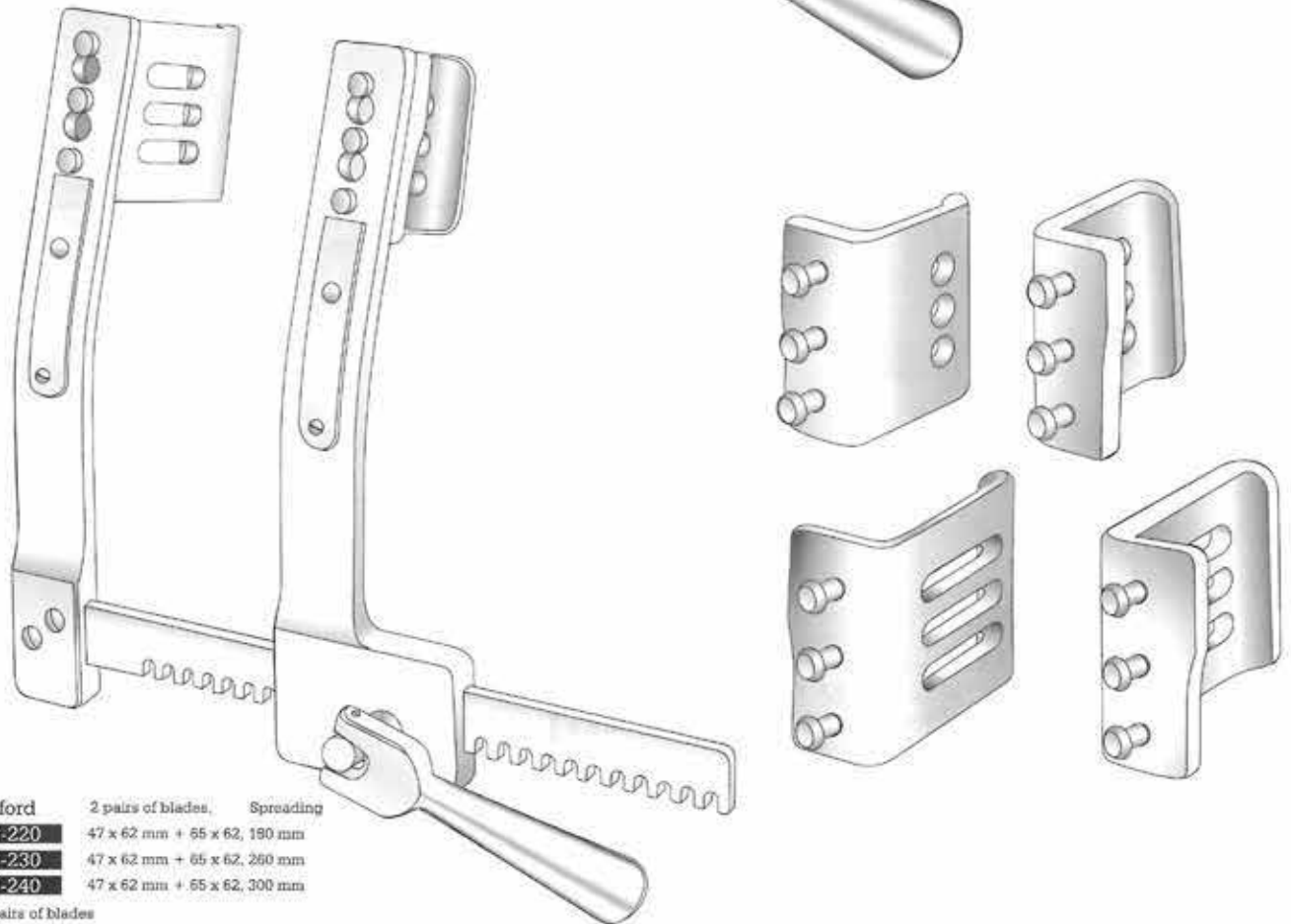
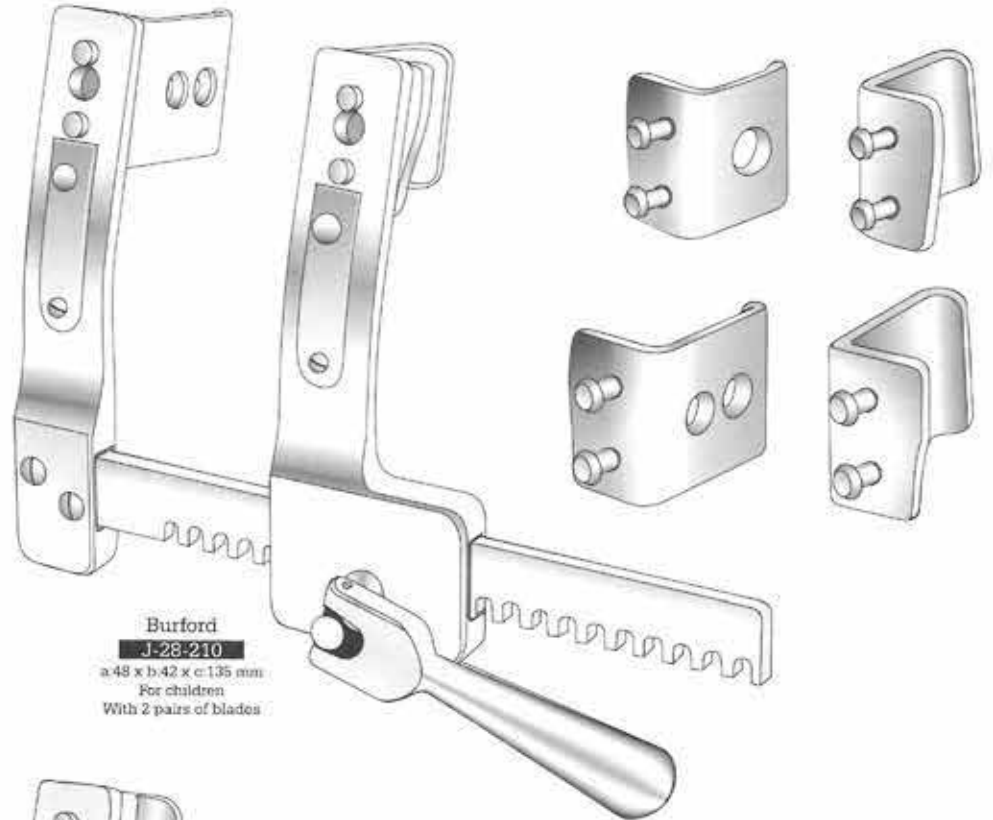
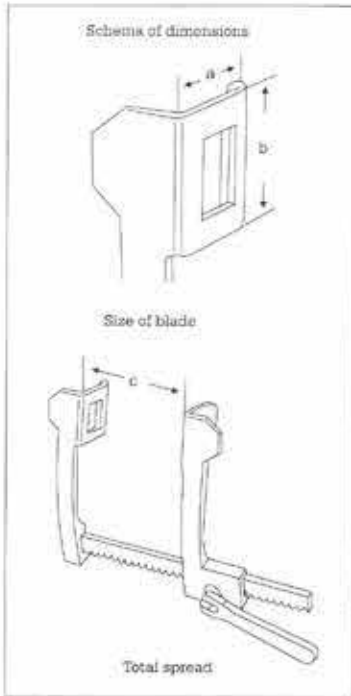

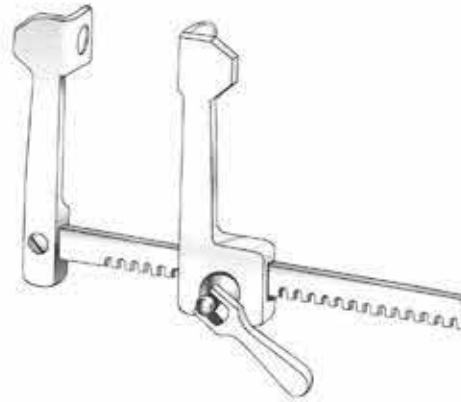
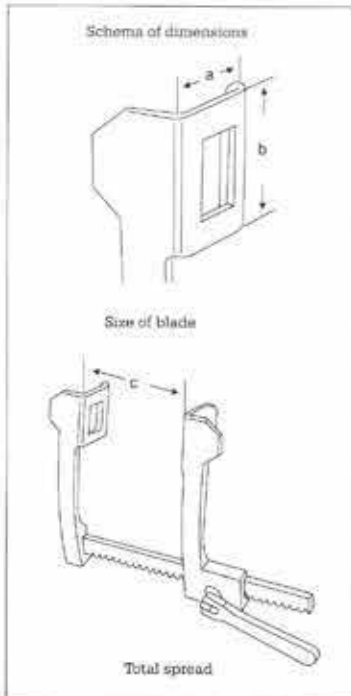

**Tiny Finochietto**

**J-28-635**

a: 20 mm, b: 20 mm, c: 65 mm

**Finochietto**

**J-28-640**

a: 15 mm, b: 15 mm, c: 75 mm

For babies, lateral blades, spreading

For infant

**J-28-645**

a: 20 mm, b: 15 mm, c: 75 mm

**J-28-650**

a: 25 mm, b: 20 mm, c: 50 mm

**J-28-655**

a: 25 mm, b: 20 mm, c: 85 mm

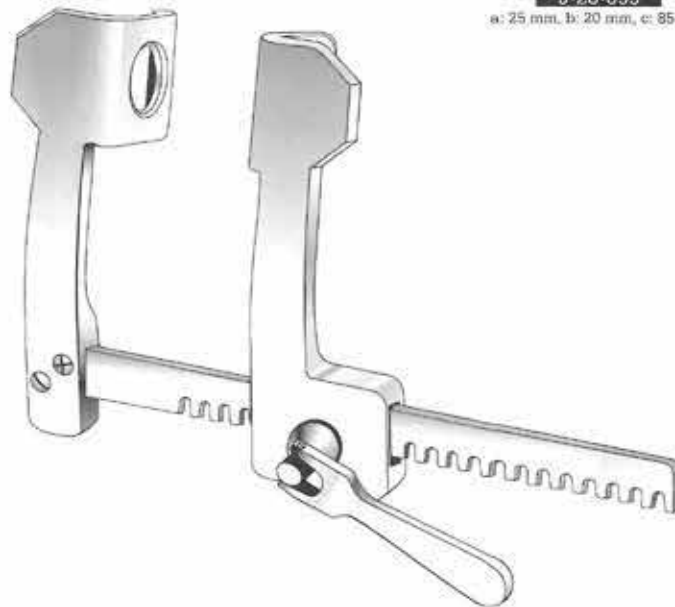

**Finochietto**

**J-28-380**

a: 31 mm, b: 31 mm, c: 100 mm

For babies, lateral blades, spreading

For infant

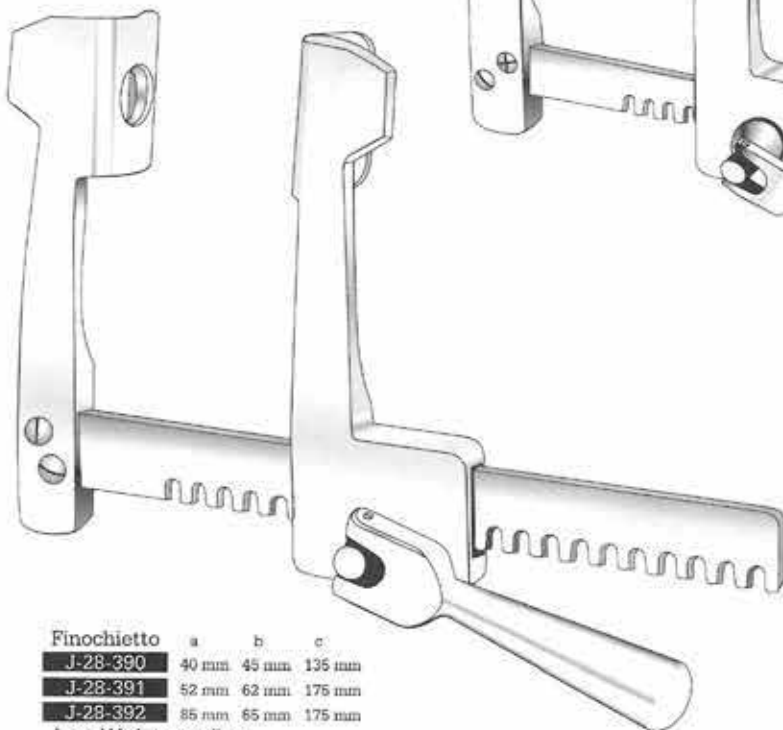

**Finochietto**

	a	b	c
<b>J-28-390</b>	40 mm	45 mm	136 mm
<b>J-28-391</b>	52 mm	62 mm	176 mm
<b>J-28-392</b>	85 mm	65 mm	175 mm

Lateral blades, spreading

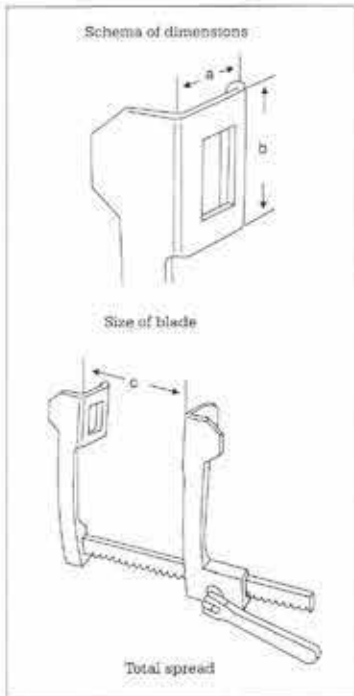

**Castaneda**  
**J-28-400**  
 a: 10.5 mm, b: 32 mm, c: 65 mm  
 For babies, lateral blades, spreading



**Castaneda**  
**J-28-410**  
 a: 12 mm, b: 45 mm, c: 70 mm  
 For infants, lateral blades, spreading

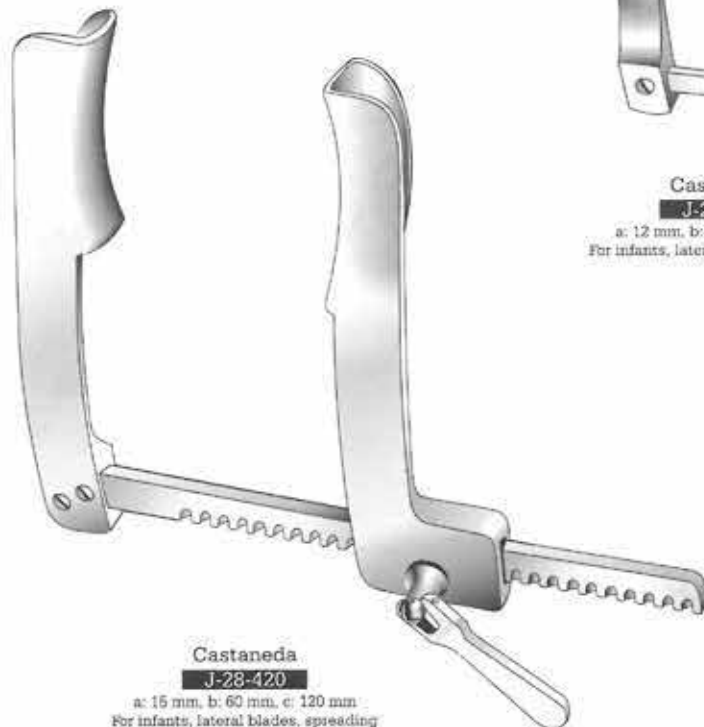

**Castaneda**  
**J-28-420**  
 a: 15 mm, b: 60 mm, c: 120 mm  
 For infants, lateral blades, spreading

# Rib Shears

Rib and Sternal Retractors

Rippensperrer und Sternumspreizer

Separadores costales Y esternales

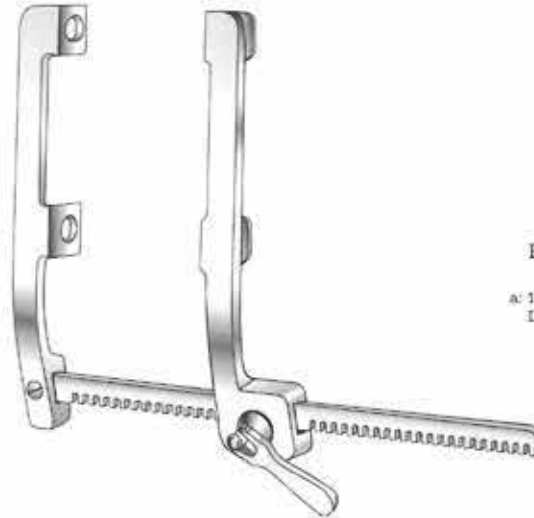
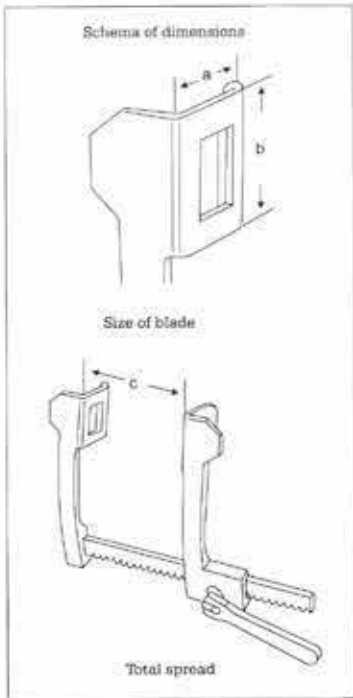

Finochietto (modif)

**J-28-430**

a: 14 mm, b: 15 mm, c: 120 mm  
Lateral blades, spreading

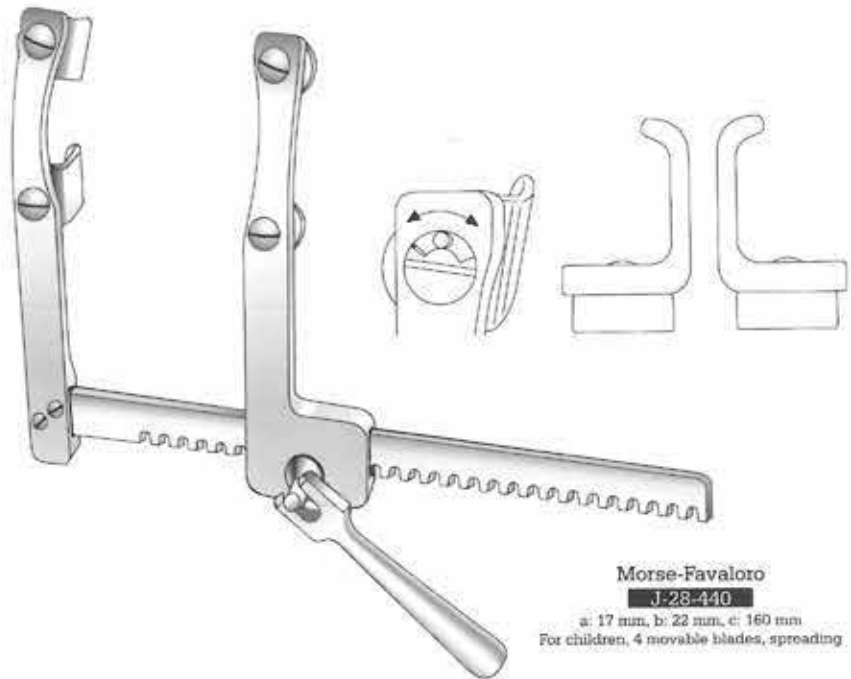

Morse-Favaloro

**J-28-440**

a: 17 mm, b: 22 mm, c: 160 mm  
For children, 4 movable blades, spreading

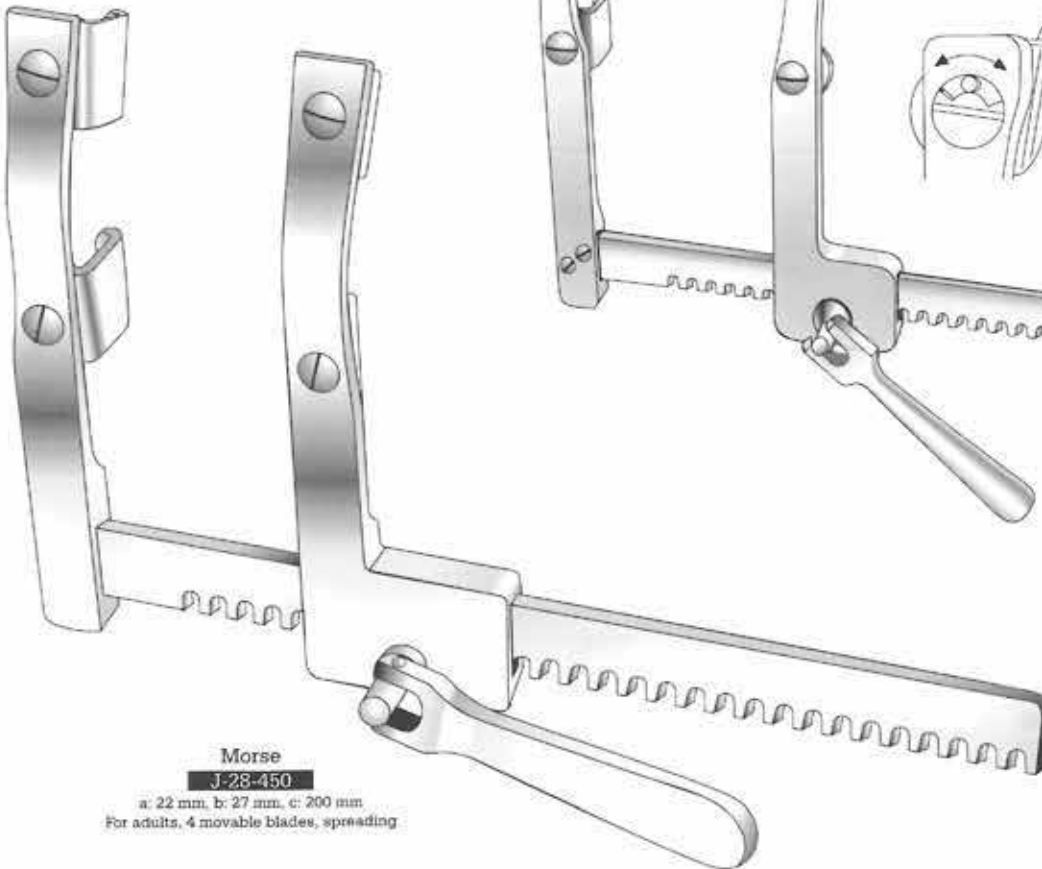

Morse

**J-28-450**

a: 22 mm, b: 27 mm, c: 200 mm  
For adults, 4 movable blades, spreading

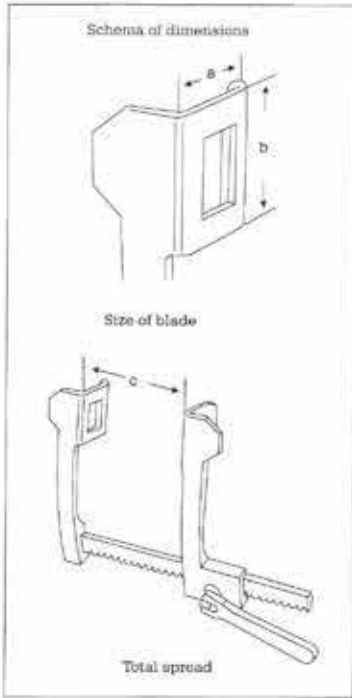

30 x 30 mm  
 Lateral blades  
 Fig. 1



40 x 40 mm  
 Lateral blades  
 Fig. 2



50 x 50 mm  
 Lateral blades  
 Fig. 3

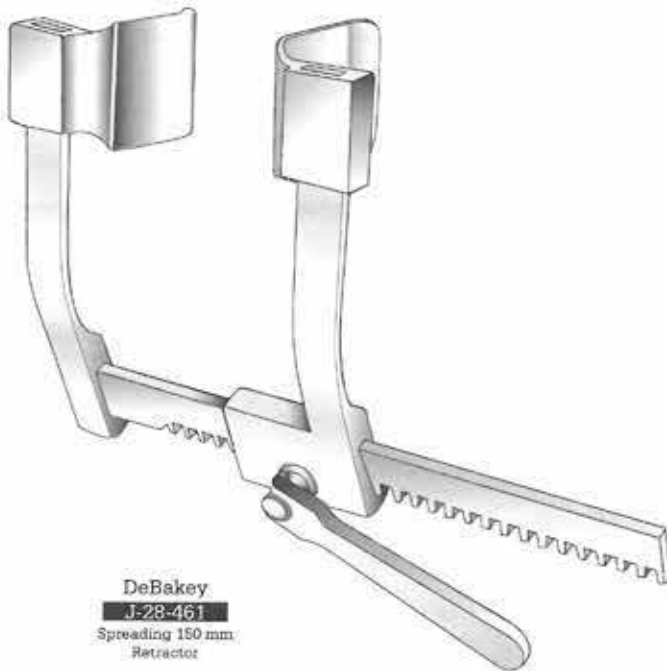

**DeBakey**  
**J-28-461**  
 Spreading 150 mm  
 Retractor

**De Bakey**  
**J-28-460**  
 Set of one retractor &  
 three blades Fig. 1 - Fig. 3



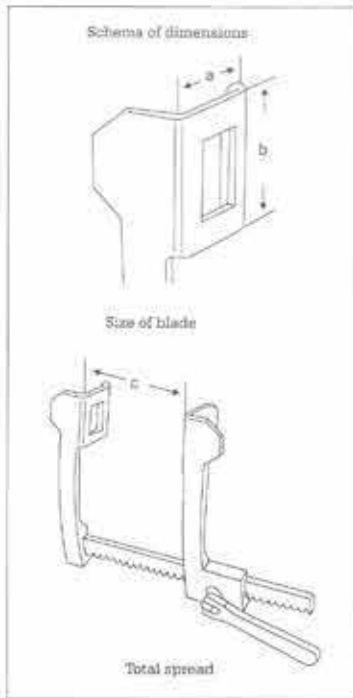

60 x 60 mm  
Lateral blades  
Fig. 1



50 x 80 mm  
Lateral blades  
Fig. 2



40 x 100 mm  
Lateral blades  
Fig. 3



80 x 60 mm  
Lateral blades  
Fig. 4



50 x 66 mm  
Lateral blades  
Fig. 5

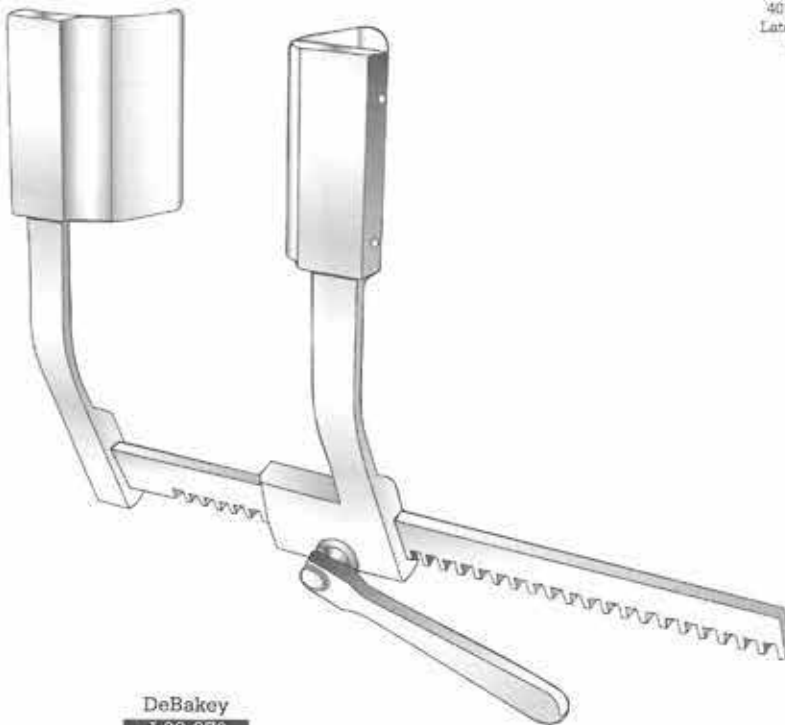

**DeBaKey**  
**J-28-870**  
 Retractor only  
 spreading 200 mm

**DeBaKey**  
**J-28-470**  
 Set of 1 retractor &  
 5 pairs of blades  
 Fig. 1 - Fig. 5





48 x 68 mm  
Fig. 1



70 x 75 mm  
Fig. 2

Mercedes Retractor  
**J-28-481**  
Complete set  
one retractor &  
one pair of blades each

# Cardiovascular Surgery

Rib Contractors

Bippenkontraktoren

Aproximadores para costillas



**Sellers**  
**J-28-360**  
20 cm / 8"

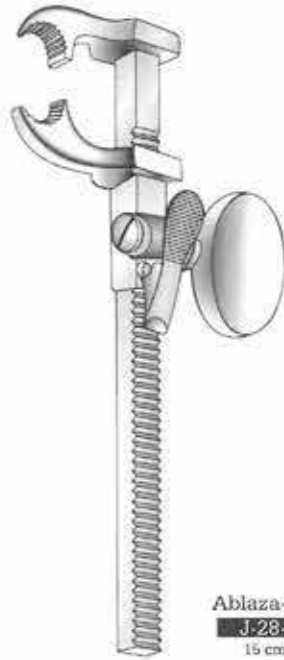

**Ablaza-Morse**  
**J-28-660**  
15 cm / 6"

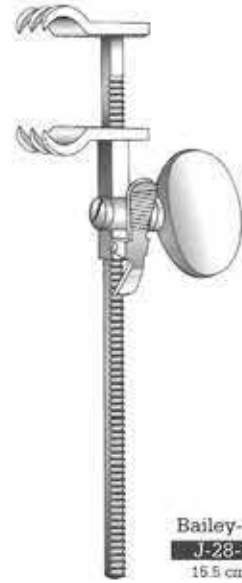

**Bailey-Baby**  
**J-28-375**  
15.5 cm / 6"

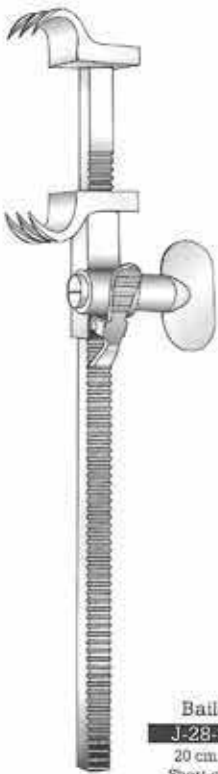

**Bailey**  
**J-28-340**  
20 cm / 8"  
Short claws



**Bailey-Gibbon**  
**J-28-350**  
20 cm / 8"  
Long claws



**Lemmon**  
**J-28-665**  
14 cm / 5 1/2"  
**J-28-670**  
18 cm / 7"  
Sternum-approximator  
For adults

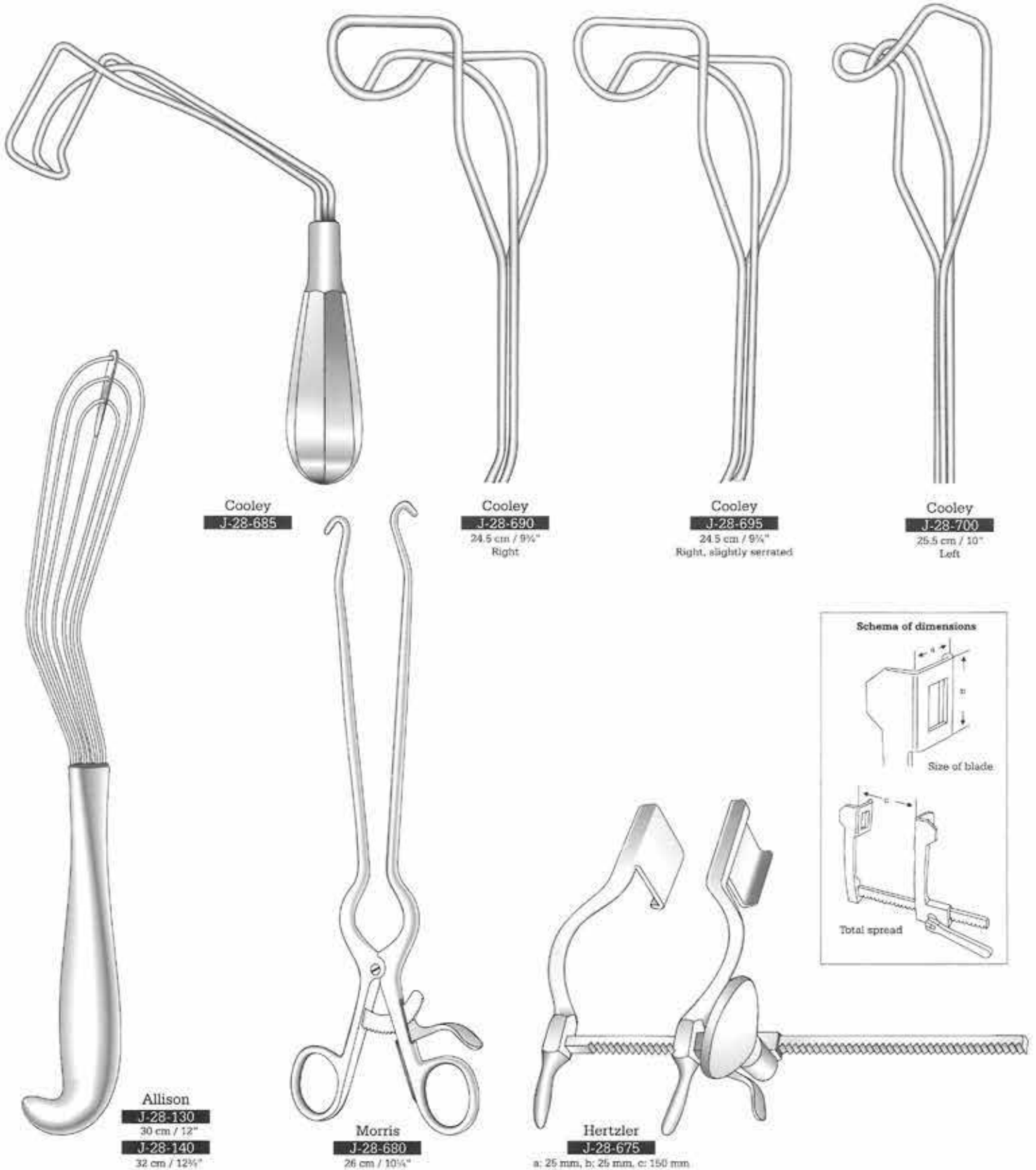

# Cardiovascular Forceps

Lung Grasping Forceps, Blood Vessel Clamps

Lungenfasszangen, Gefassklemmen

Pinzas—Clamps p/pulmon, Clamps p/vasos

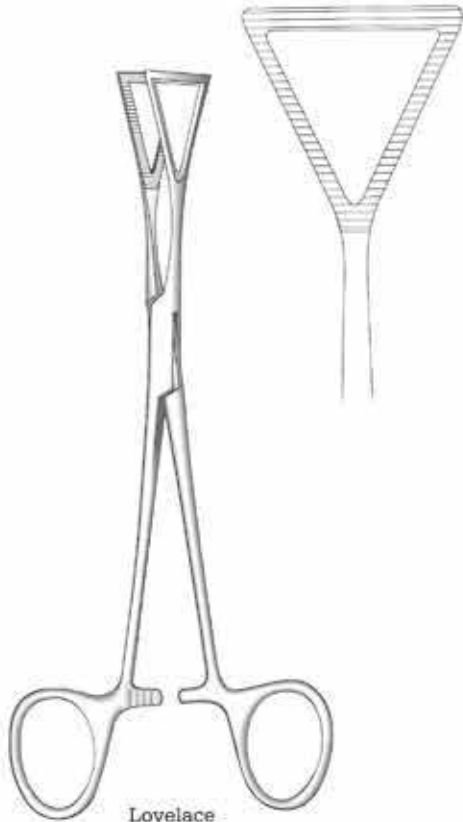

Lovelace  
J-27-001  
20 cm / 8"

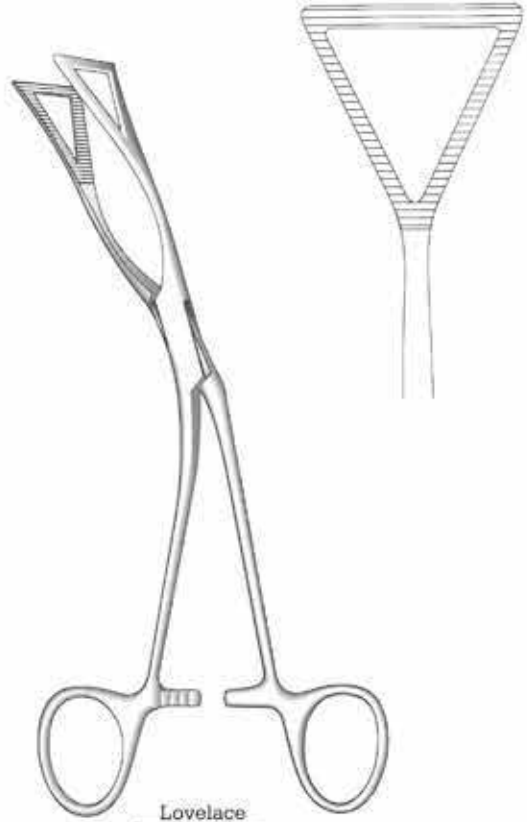

Lovelace  
J-27-010  
20 cm / 8"  
Laterally Curved



Johns Hopkins  
22 cm / 8 1/2"



J-27-020



J-27-030



**Sarot**  
 23 cm / 9"

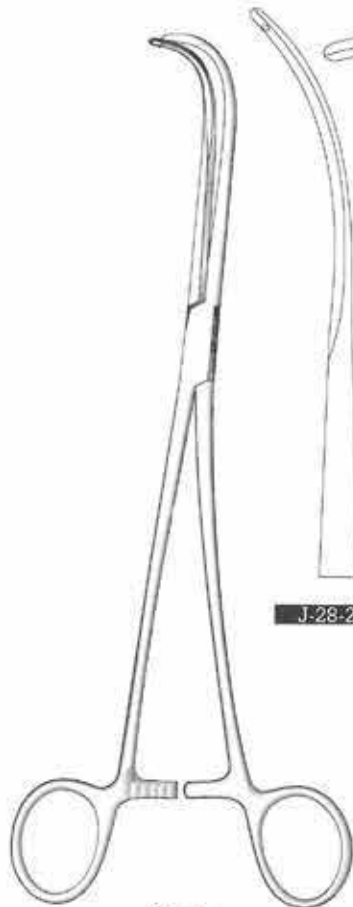
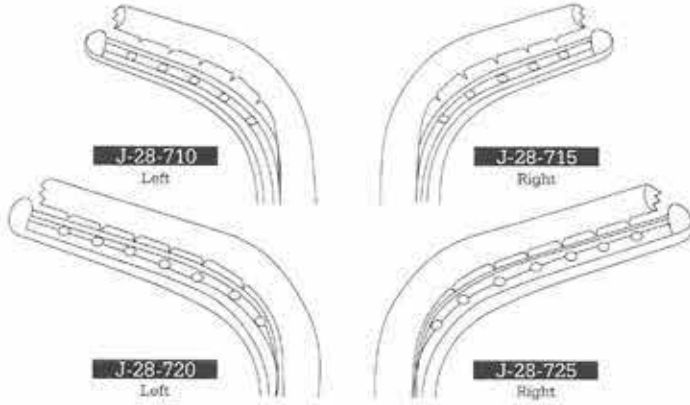

**Semb**  
 24 cm / 9 1/2"

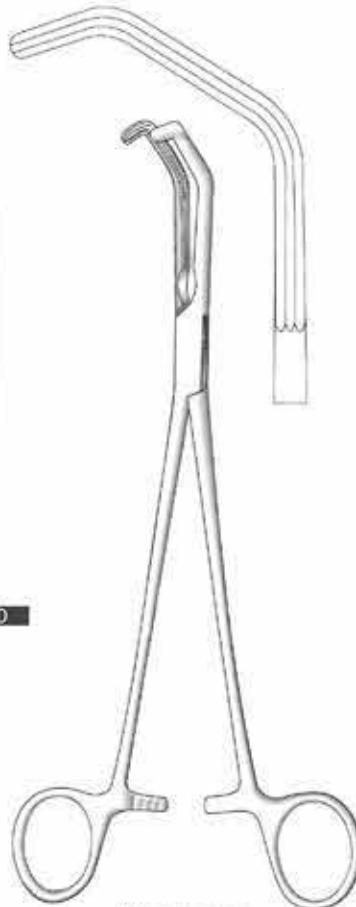
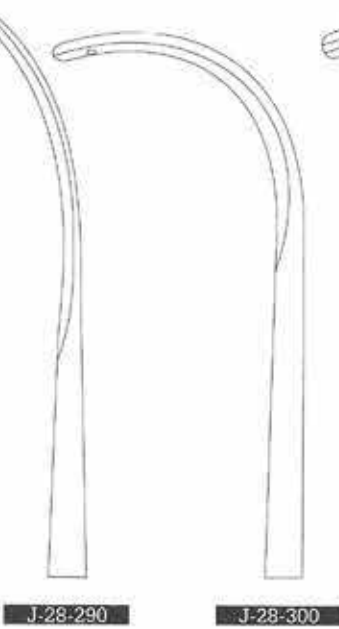

**Price-Thomas**  
**J-28-310**  
 22 cm / 8 3/4"

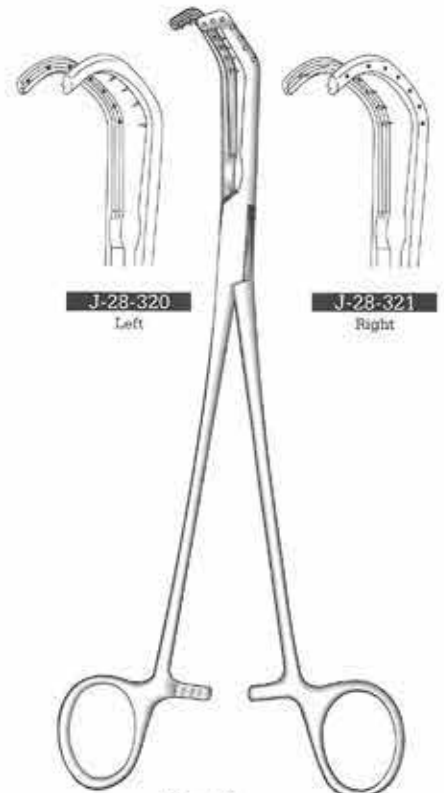

**Price-Thomas**  
 22 cm / 8 3/4"



# Cardiovascular Forceps

Blood Vessel Clamps

Gefassklemmen

Clamps p/vasos

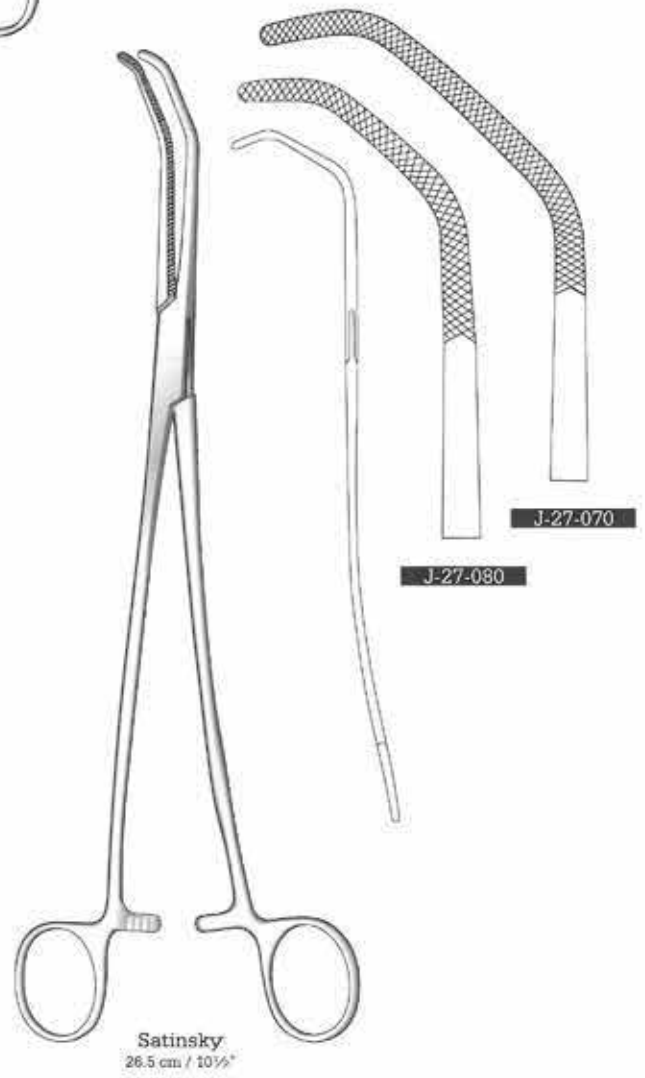
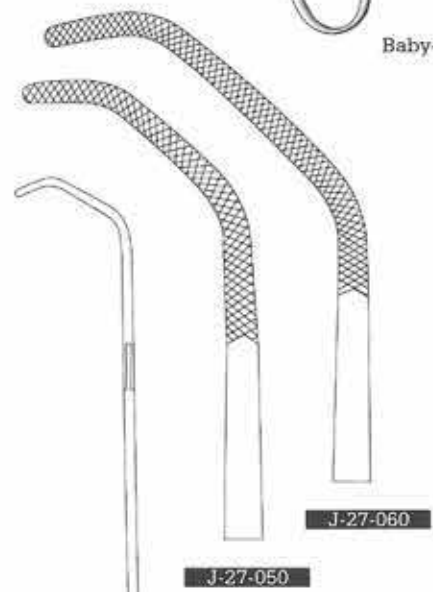
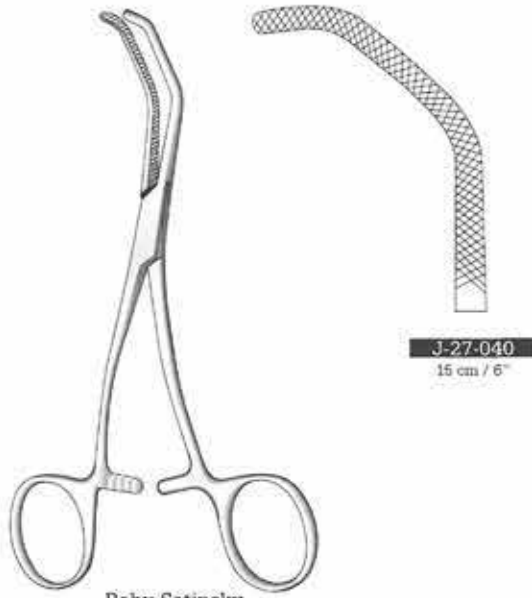

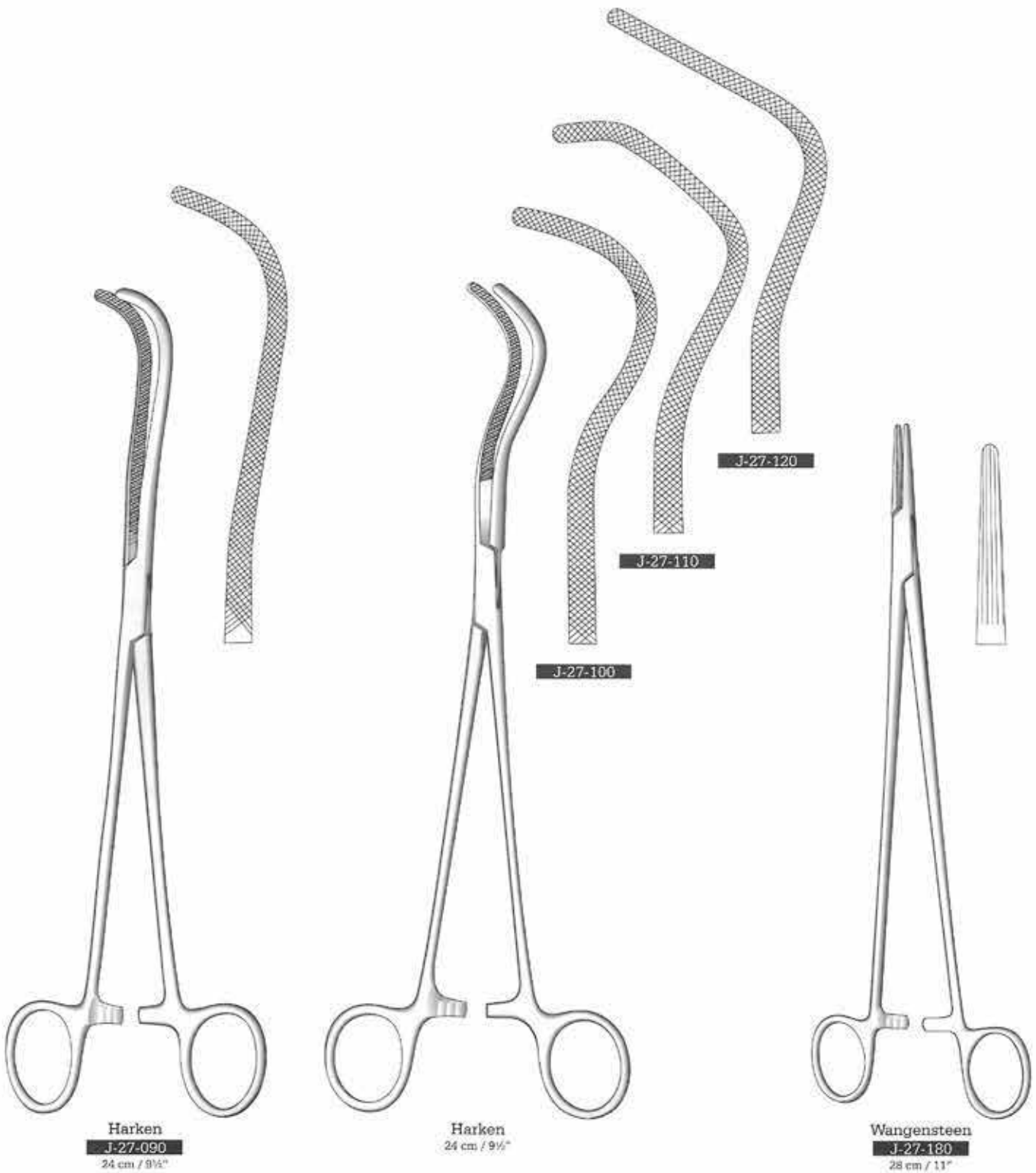



# Lung Surgery

Aorta Clamps  
Aortaklemmen  
Clamps aorta



**J-27-190**  
15 cm / 6"  
14 mm



**J-27-200**  
20 cm / 8"  
18 mm

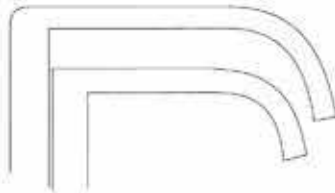

**J-27-210**  
25 cm / 10"  
23 mm

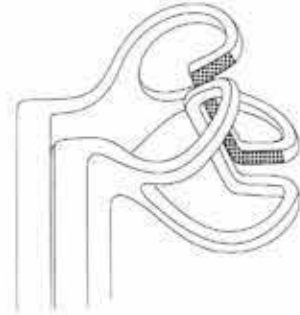

**J-27-220**  
10 0 x 19 mm

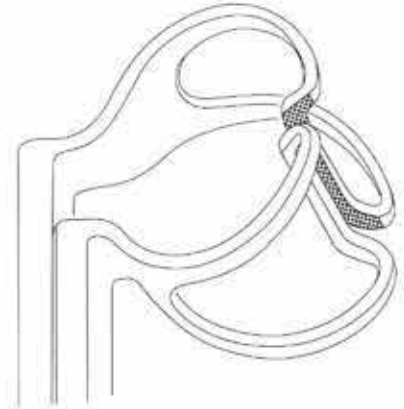

**J-27-230**  
25 0 x 25 mm

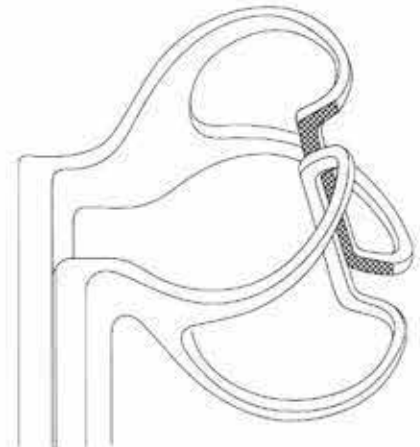

**J-27-240**  
32 0 x 32 mm

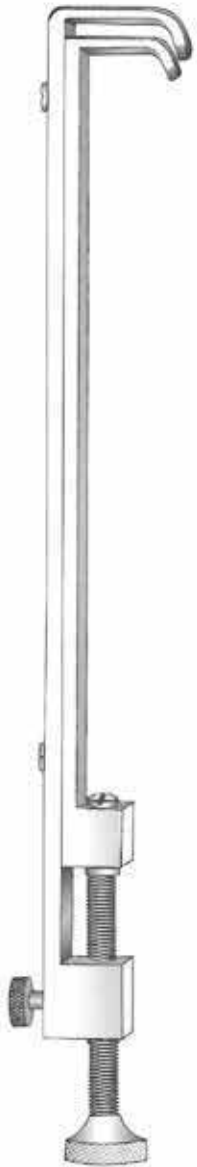

Blalock



Johns Hopkins  
20 cm / 8"

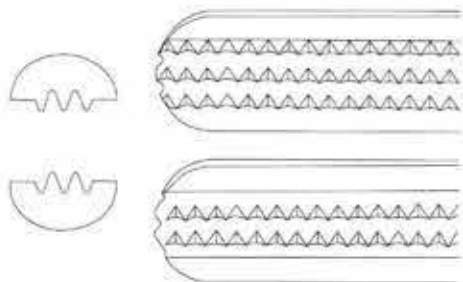

**Toothing according to De Bakey:**  
 The traditional ATRAUMA clamps.  
 Apart from Cardio-Vascular Surgery,  
 These are also approved for other  
 atraumatic applications and surgery  
 techniques. Firm and precise seizing  
 of tissues. Safe and delicately controlled  
 clamping effect.

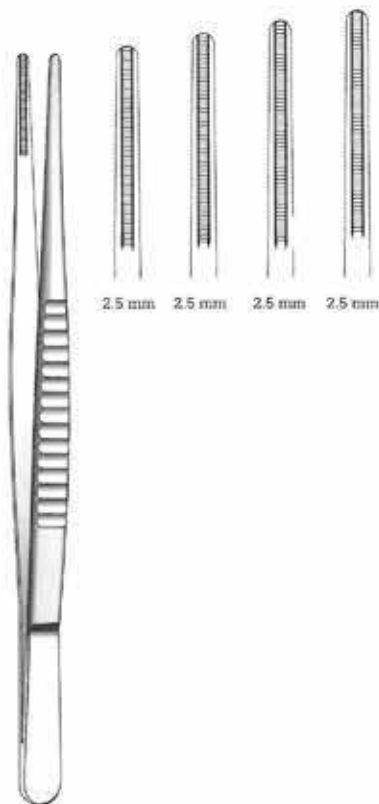
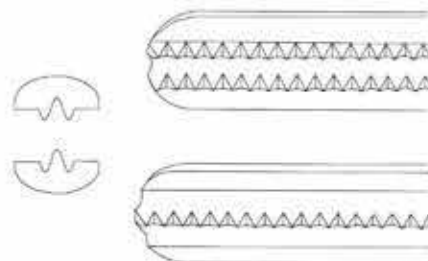

2.5 mm 2.5 mm 2.5 mm 2.5 mm

**De Bakey**

<b>J-27-250</b>	16 cm / 6 1/4"
<b>J-27-251</b>	20 cm / 8"
<b>J-27-252</b>	24 cm / 9 1/2"
<b>J-27-253</b>	30 cm / 12"

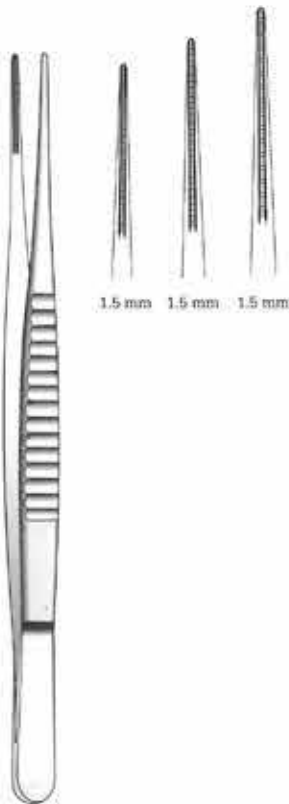

1.5 mm 1.5 mm 1.5 mm

**De Bakey**

<b>J-27-600</b>	16 cm / 6 1/4"
<b>J-27-605</b>	20 cm / 8"
<b>J-27-610</b>	24 cm / 9 1/2"

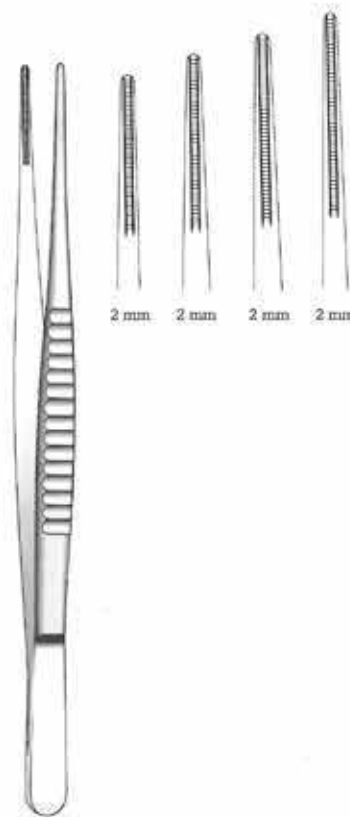

2 mm 2 mm 2 mm 2 mm

**De Bakey**

<b>J-27-620</b>	16 cm / 6 1/4"
<b>J-27-625</b>	20 cm / 8"
<b>J-27-630</b>	24 cm / 9 1/2"
<b>J-27-635</b>	30 cm / 12"

# Tissue Forceps

Vascular Forceps, Bulldog Clamps

GefaBpir1zetten, Bullclogklemmen

Pinzas de disseccion Vascular, Clamps Bulldog

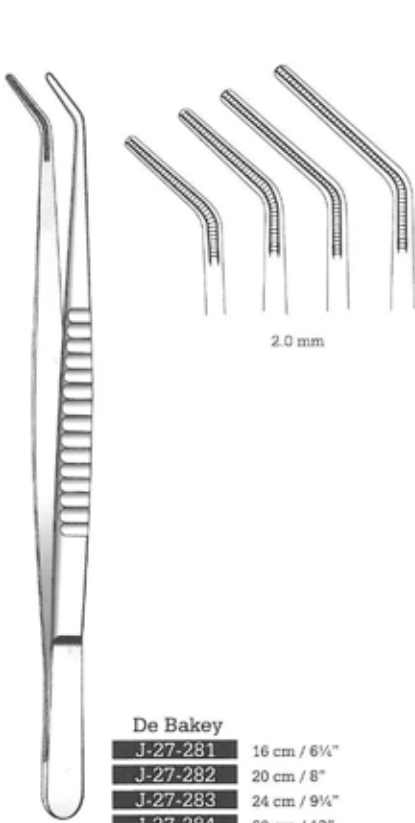

**De Bakey**  
**J-27-281** 16 cm / 6 1/4"  
**J-27-282** 20 cm / 8"  
**J-27-283** 24 cm / 9 1/4"  
**J-27-284** 30 cm / 12"

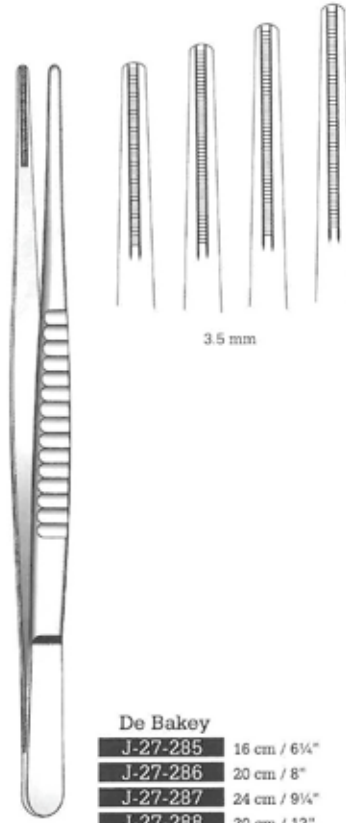

**De Bakey**  
**J-27-285** 16 cm / 6 1/4"  
**J-27-286** 20 cm / 8"  
**J-27-287** 24 cm / 9 1/4"  
**J-27-288** 30 cm / 12"

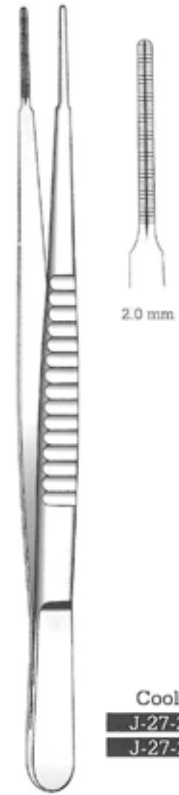

**Cooley**  
**J-27-289** 16 cm / 6 1/4"  
**J-27-291** 20 cm / 8"



**J-27-292** 6 cm / 2 1/2"  
**J-27-293** 7 cm / 2 3/4"  
**J-27-294** 9 cm / 3 1/2"  
**J-27-295** 11 cm / 4 1/2"

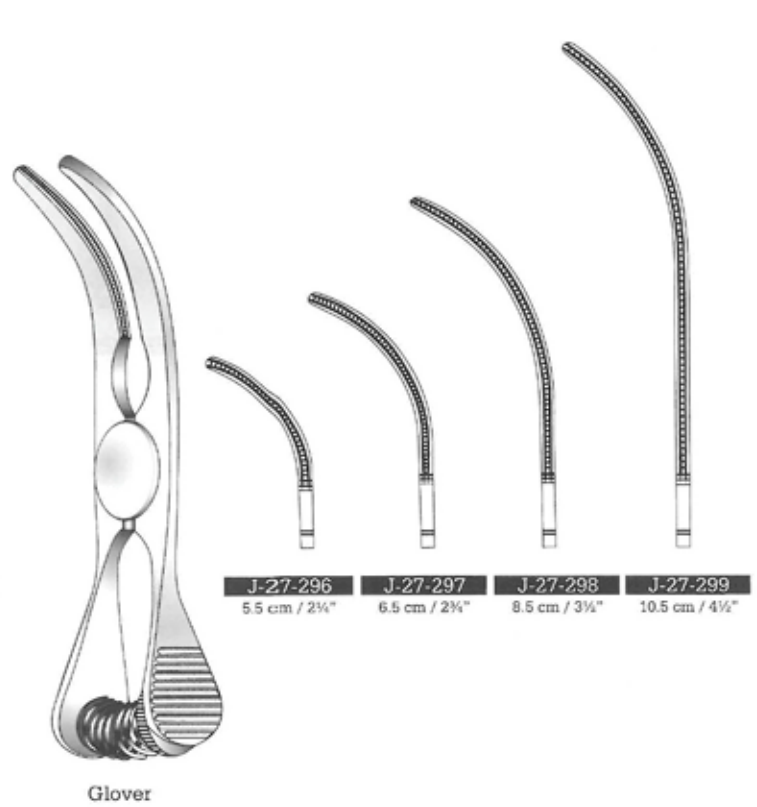

**J-27-296** 5.5 cm / 2 1/4"  
**J-27-297** 6.5 cm / 2 3/4"  
**J-27-298** 8.5 cm / 3 1/4"  
**J-27-299** 10.5 cm / 4 1/2"

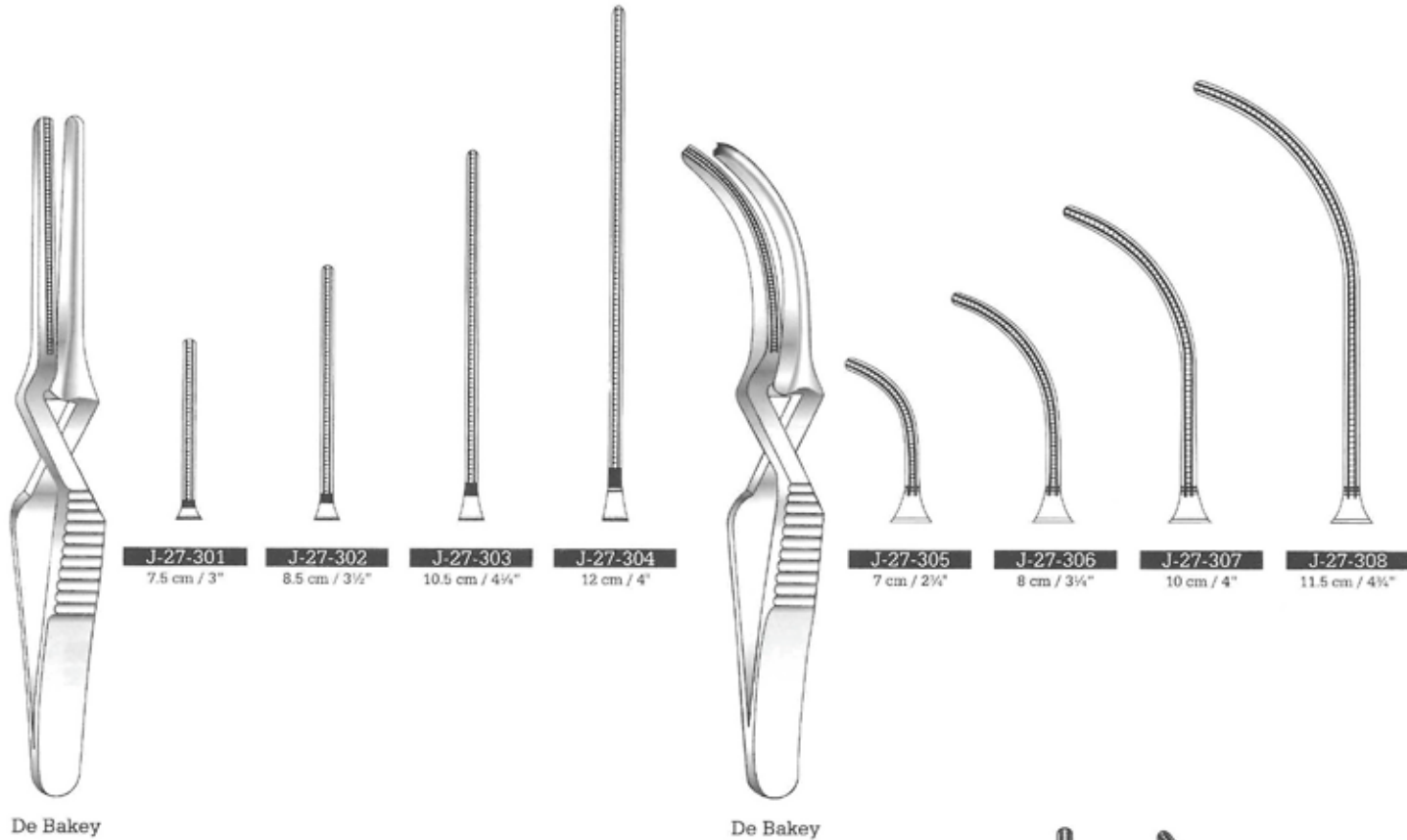

De Bakey

De Bakey



De Bakey-Mosquito

De Bakey-Crile  
 J-27-314 Straight  
 J-27-315 Curved  
 14 cm / 5½"  
 De Bakey-Crile-Rankin  
 J-27-316 Straight  
 J-27-317 Curved  
 16 cm / 6¼"

# Cardiovascular Forceps

Atrauma Haernostatic Forceps and Atrauma Cardiovascular Forceps

Atrauma-Arterienklemmen und Atrauma Cardiovascular-Klemmen

Atrauma hemostaticas Pinzas Y Atrauma Pinzas-Clamps Cardiovasculares

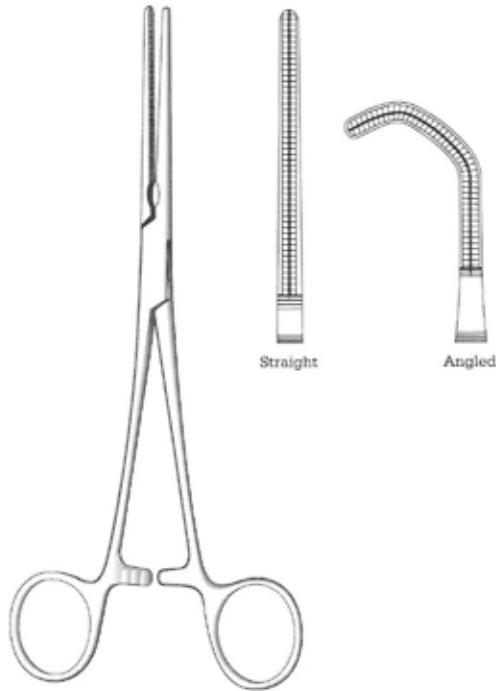

Straight

Angled

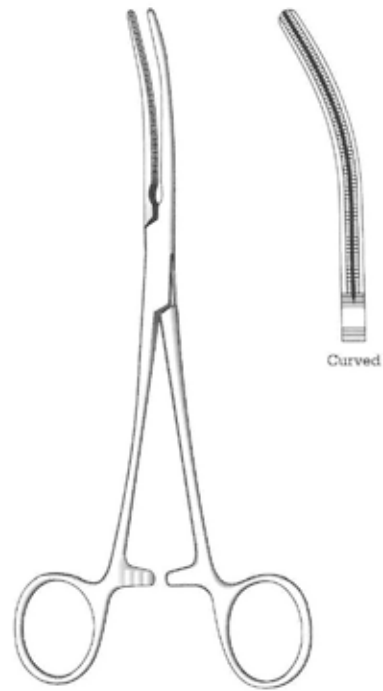

Curved

## De Bakey-Pean

J-27-318	16.5 cm / 6½"	J-27-640
J-27-319	18.5 cm / 7¼"	J-27-642
J-27-321	20.5 cm / 8"	J-27-644
J-27-322	26 cm / 10¼"	J-27-646
J-27-323	28 cm / 11"	J-27-648

Straight

Angled

## De Bakey-Pean

J-27-324	16.5 cm / 6½"
J-27-325	18.5 cm / 7¼"
J-27-326	20.5 cm / 8"
J-27-327	26 cm / 10¼"
J-27-328	28 cm / 11"

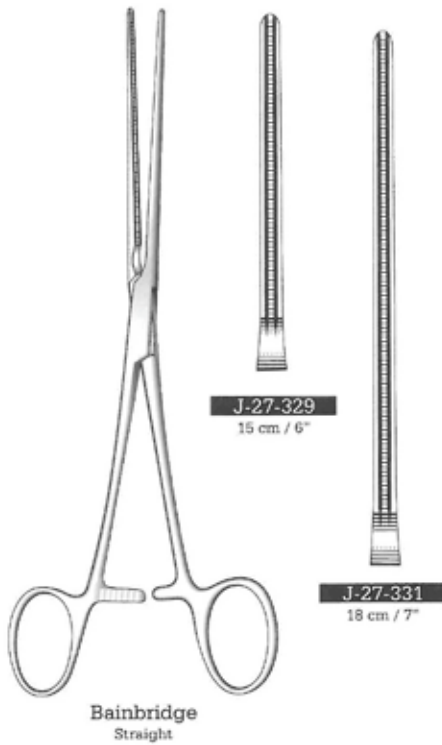

Bainbridge  
Straight

J-27-329  
15 cm / 6"

J-27-331  
18 cm / 7"

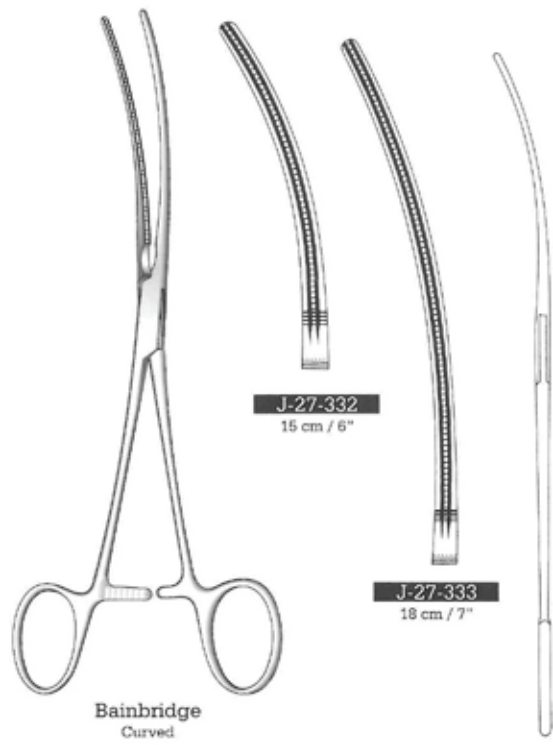

Bainbridge  
Curved

J-27-332  
15 cm / 6"

J-27-333  
18 cm / 7"

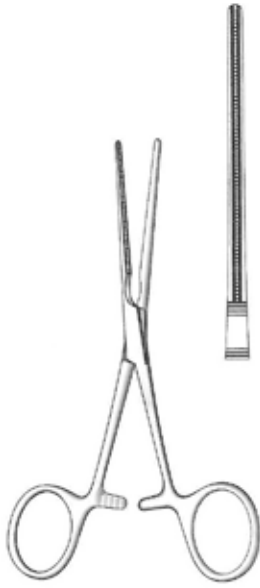

**De Bakey**  
**J-27-334**  
 12 cm / 4 3/4"

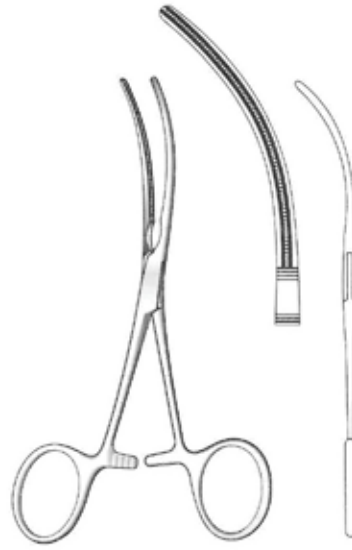

**De Bakey**  
**J-27-335**  
 11 cm / 4 1/4"

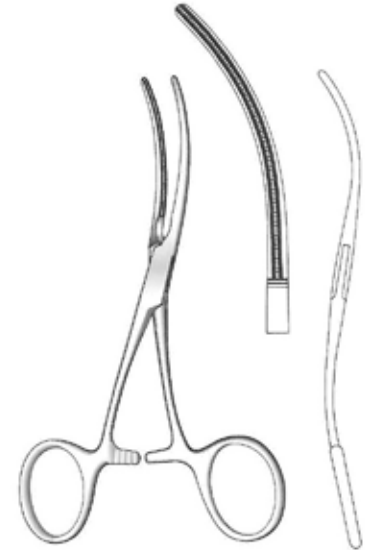

**De Bakey**  
**J-27-336**  
 12 cm / 4 3/4"



**De Bakey**  
**J-27-337**  
 10 cm / 4"

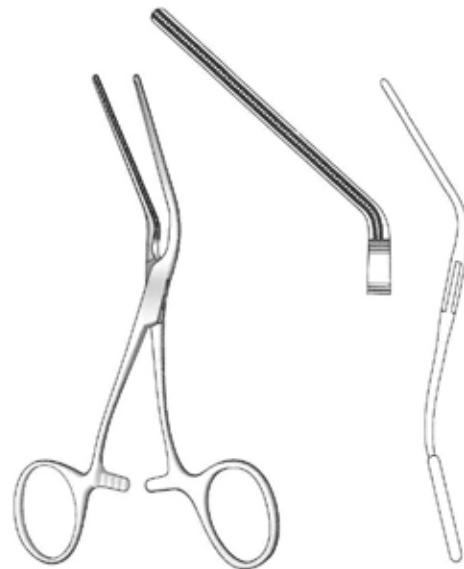

**De Bakey**  
**J-27-338**  
 13 cm / 5 1/4"



**Cardiovascular Forceps**  
Atrauma Cardiovascular Forceps  
Atrauma Cardiovascular - Klemmen  
Atrauma Pinzas-clamps cardiovasculares



**De Bakay**  
**J-27-339**  
17 cm / 6 3/4"



**De Bakay**  
**J-27-341**  
16 cm / 6 1/4"

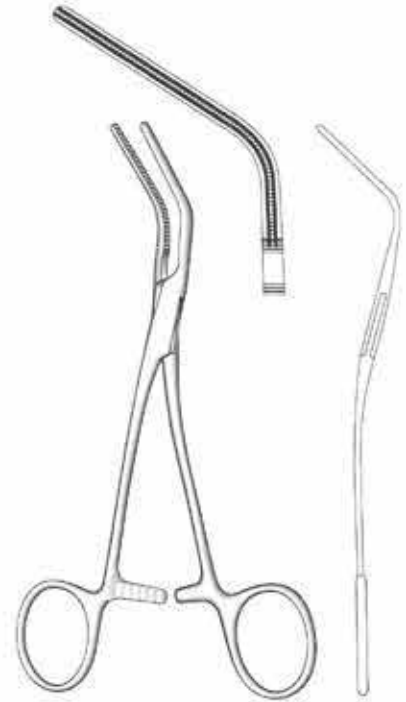

**De Bakay**  
**J-27-342**  
15 cm / 6"



**De Bakay**  
**J-27-343**  
15 cm / 6"

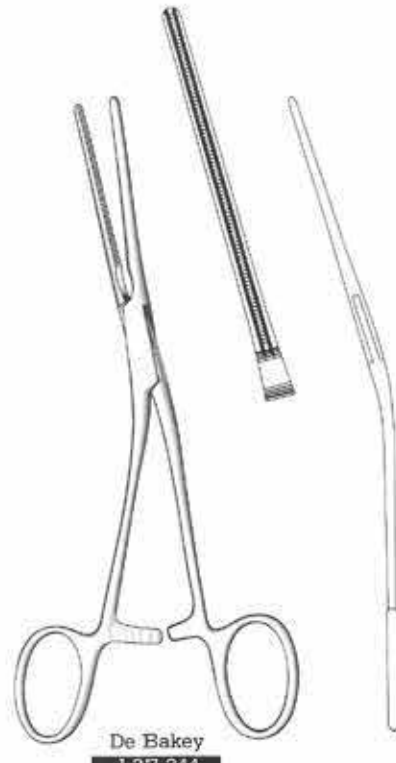

**De Bakay**  
**J-27-344**  
17 cm / 6 3/4"



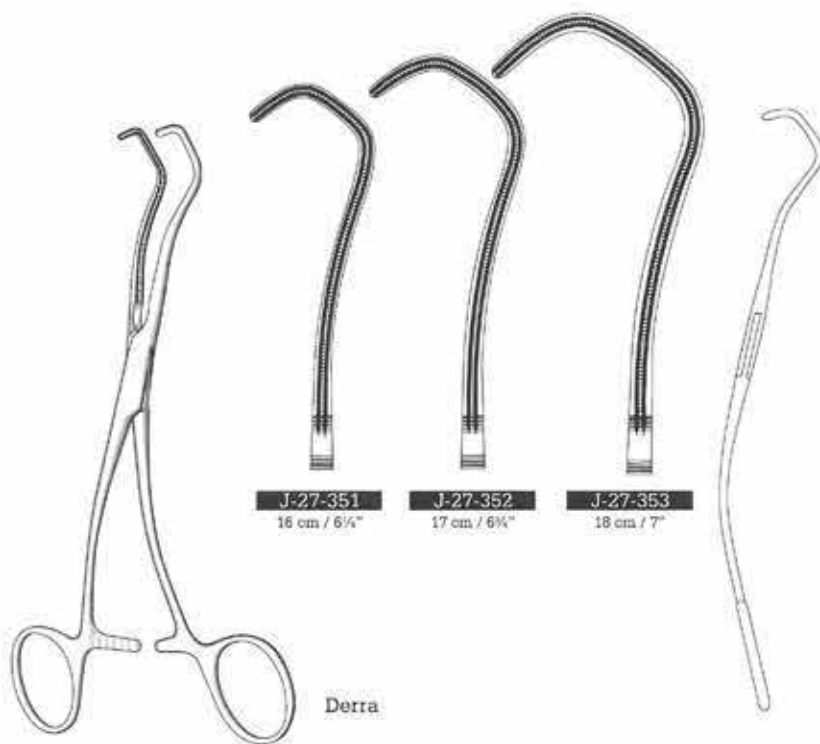
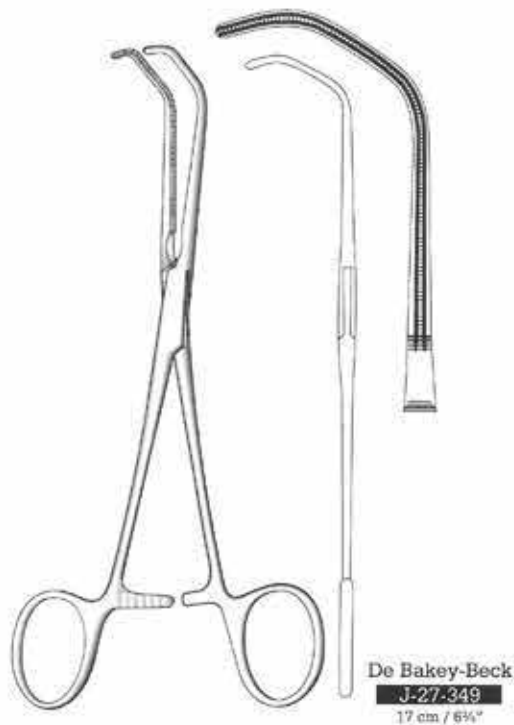
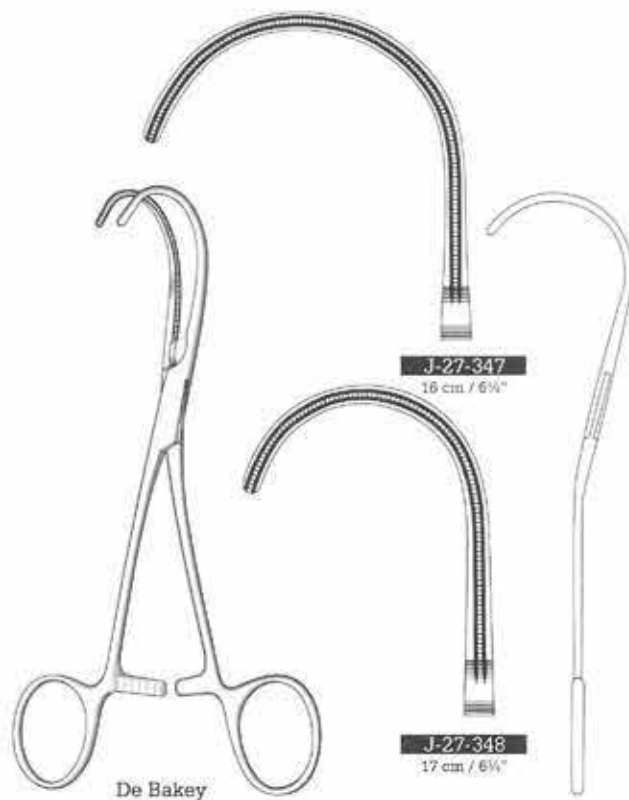
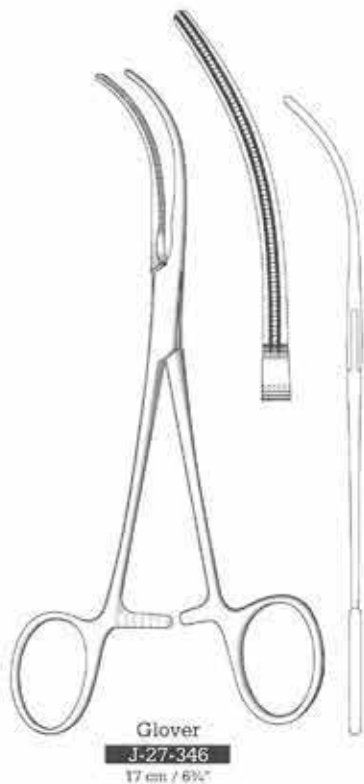
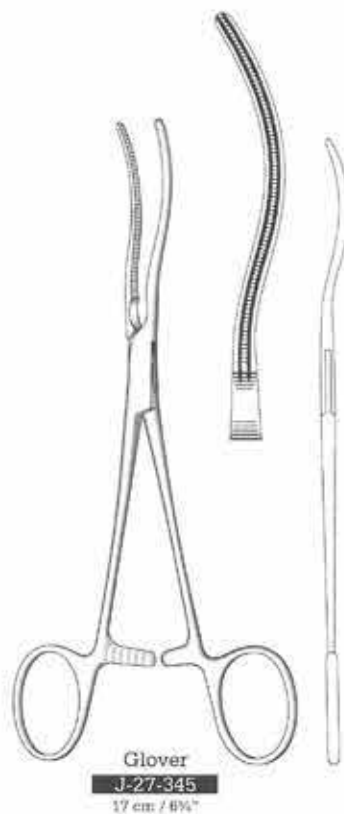

**Cardiovascular Forceps**  
**Atrauria Cardiovascular Forceps**  
**Atrauma Cardiovascular - Klemmen**  
**Atrauma Pinzas- Clamps Cardiovasculares**

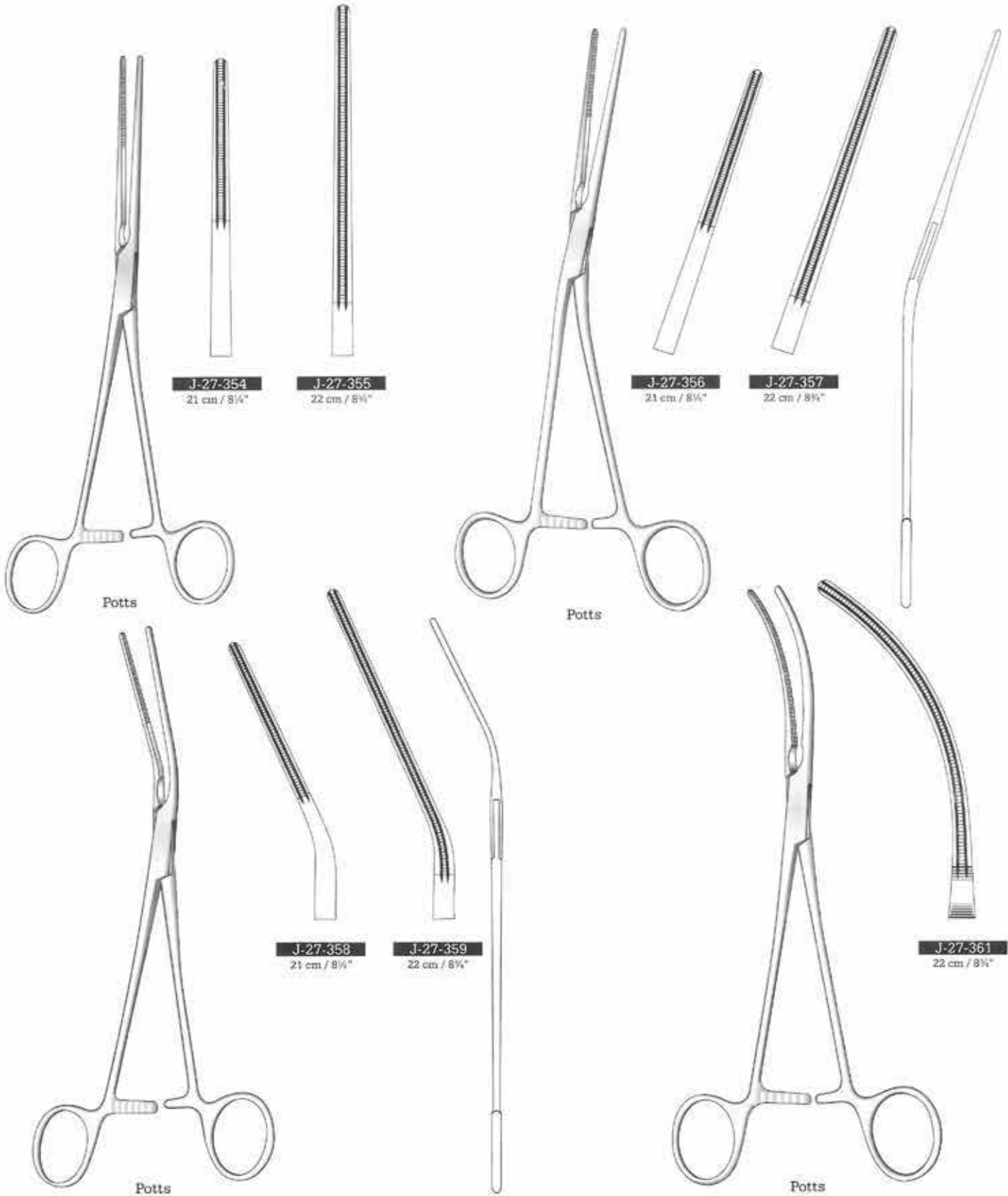

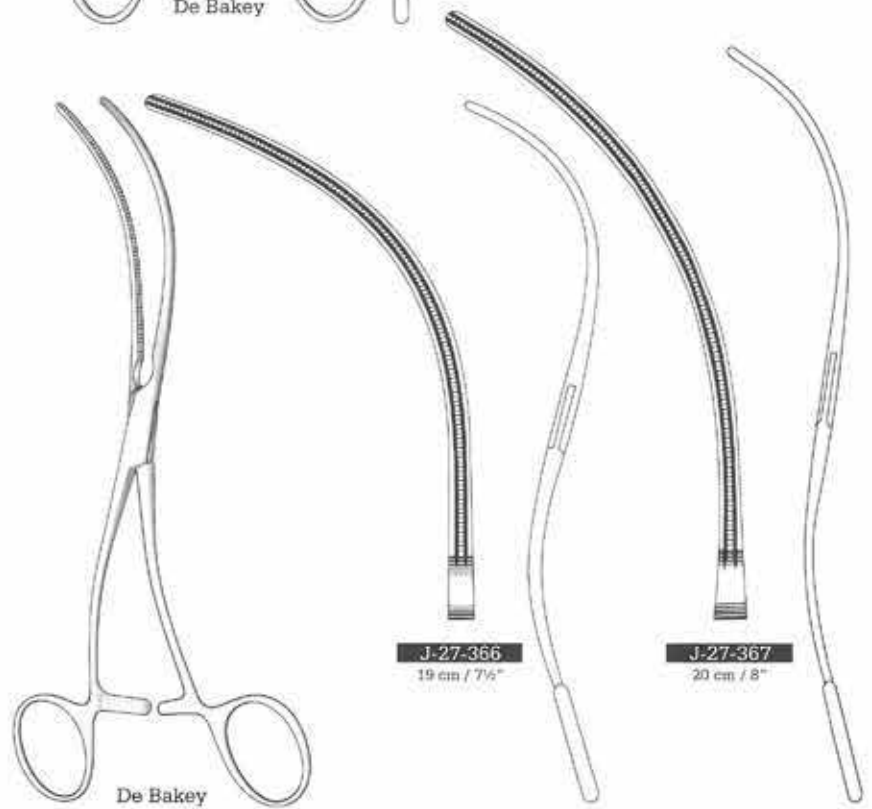
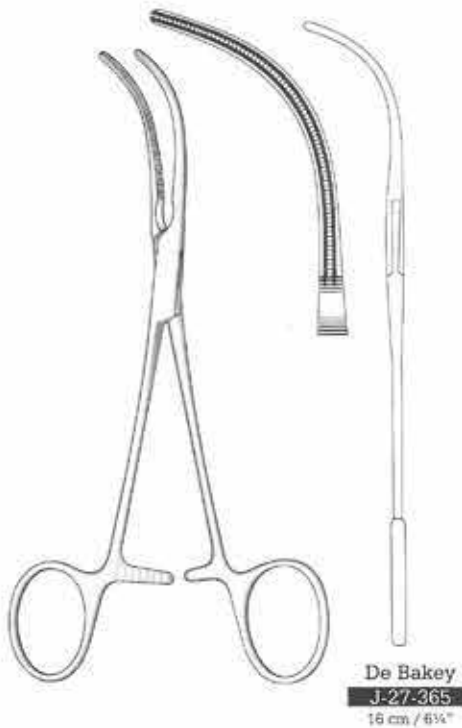
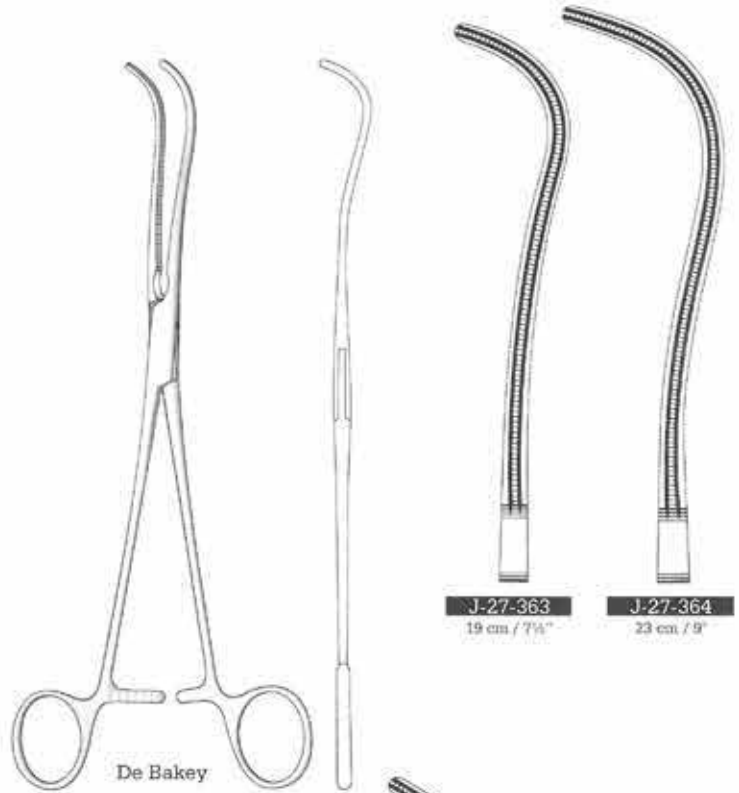
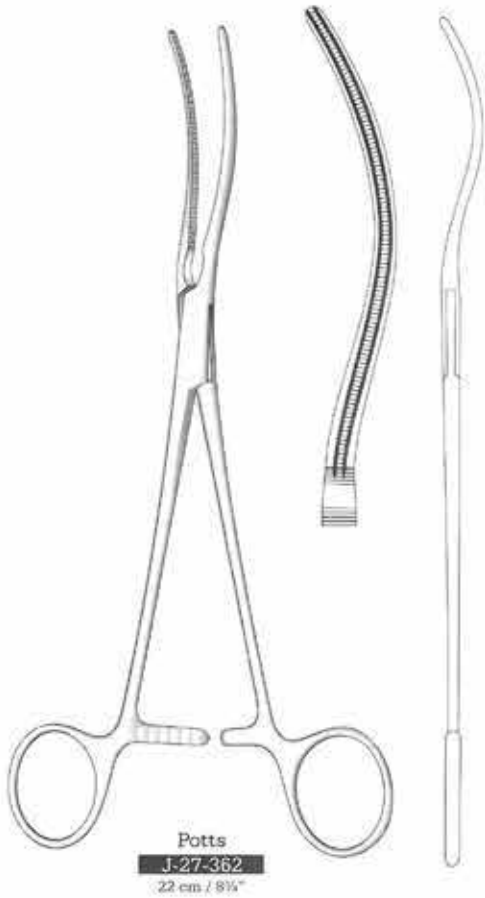

**Cardiovascular Forceps**  
Atrauma Cardiovascular Forceps  
Atrauma Cardiovascular-Klemmen  
Atrauma Pinzas-Clamps Cardiovasculares

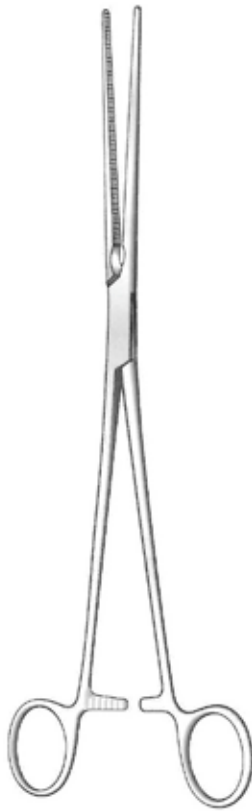

Potts  
Straight



J-27-368  
21.5 cm / 8½"



J-27-369  
23 cm / 9"



J-27-371  
27 cm / 10½"



J-27-372  
31.5 cm / 12½"



Potts  
Curved



J-27-373  
21.5 cm / 8½"



J-27-374  
23 cm / 9"



J-27-375  
27 cm / 10½"



J-27-376  
31.5 cm / 12½"

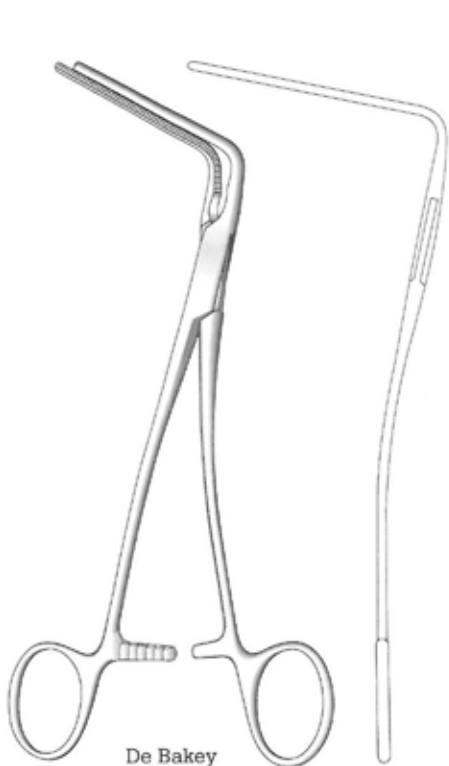

De Bakey

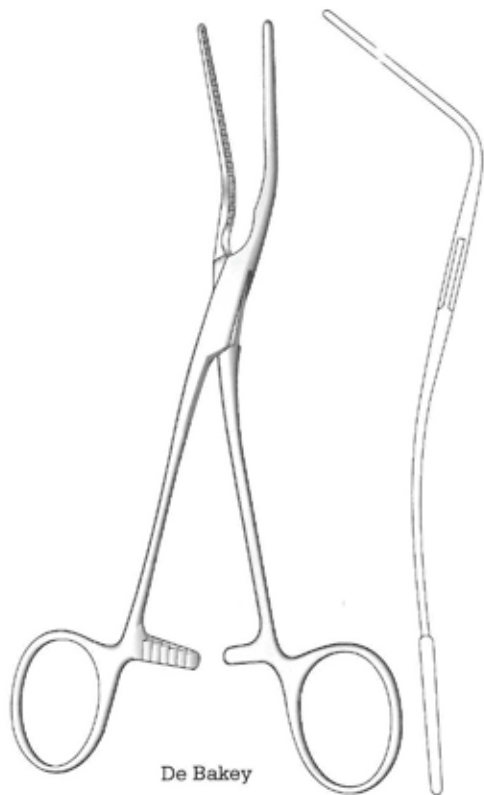
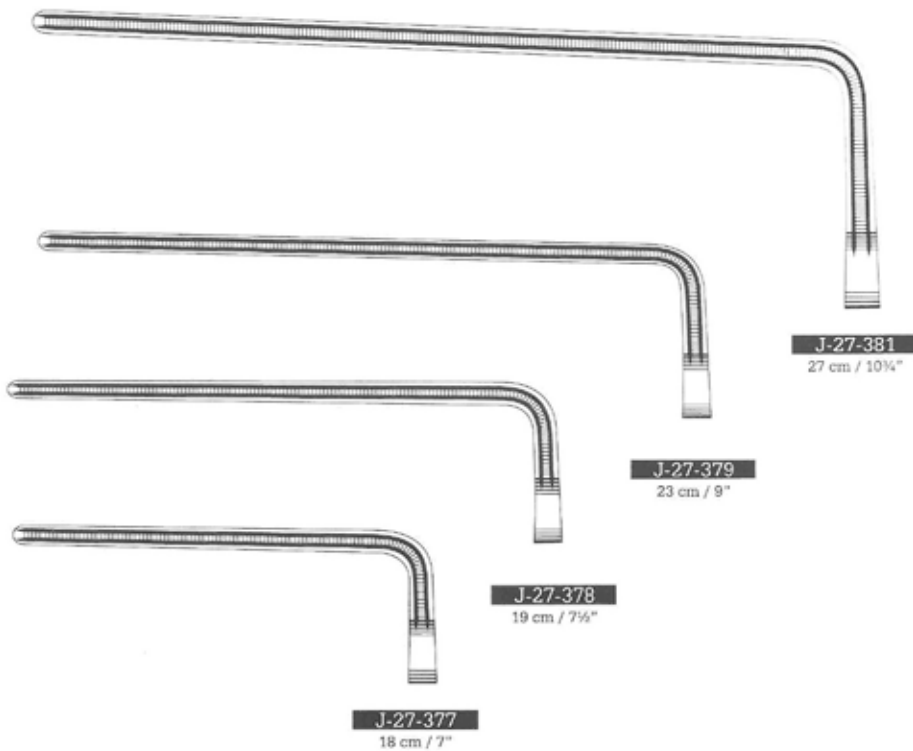

De Bakey

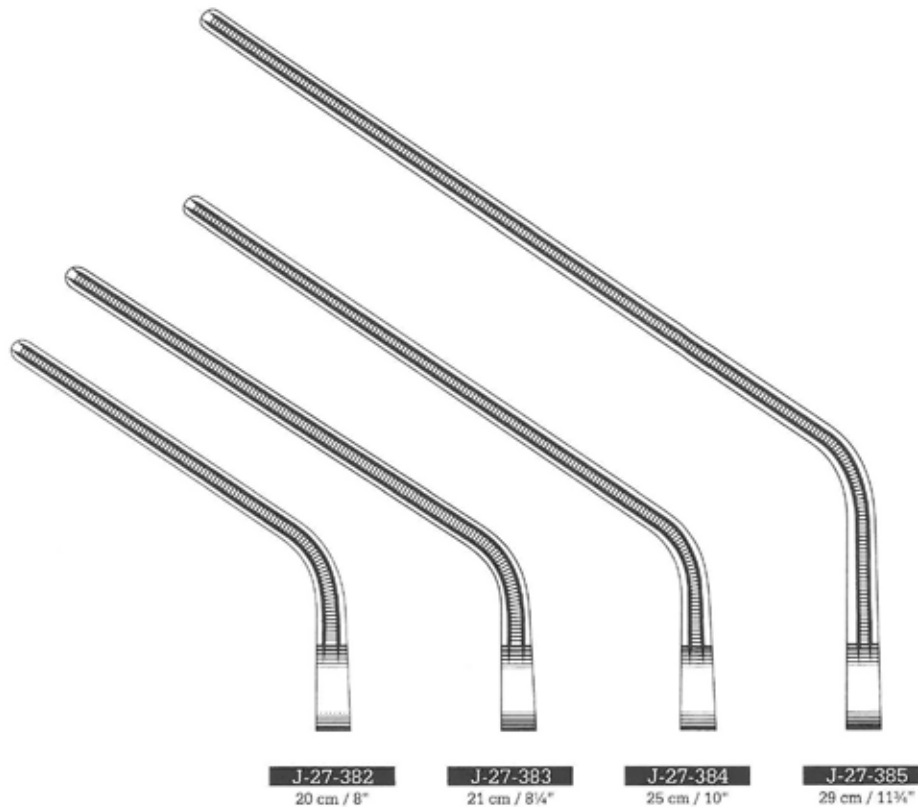



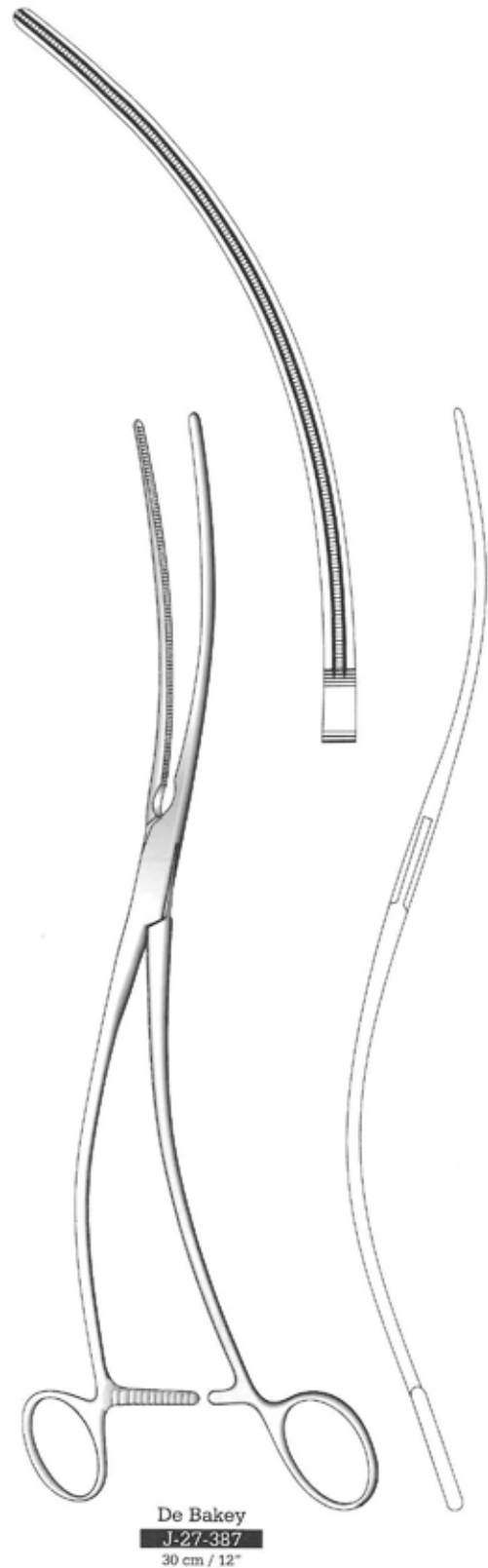
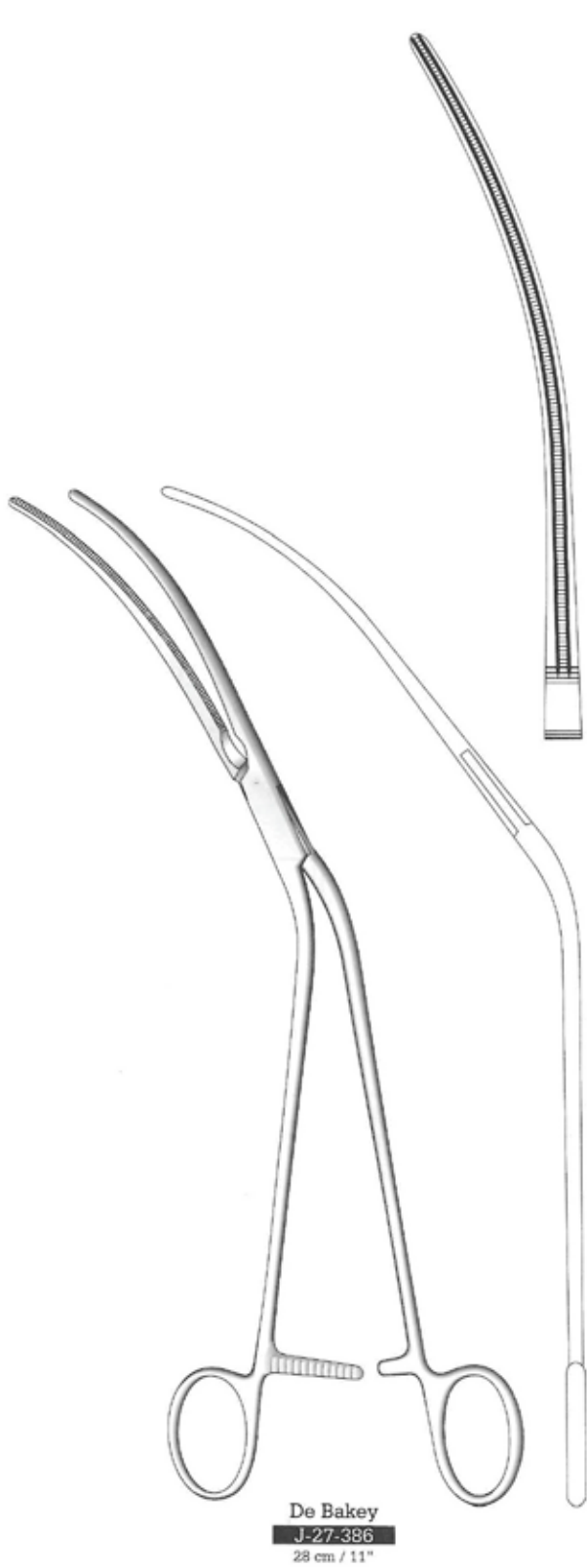

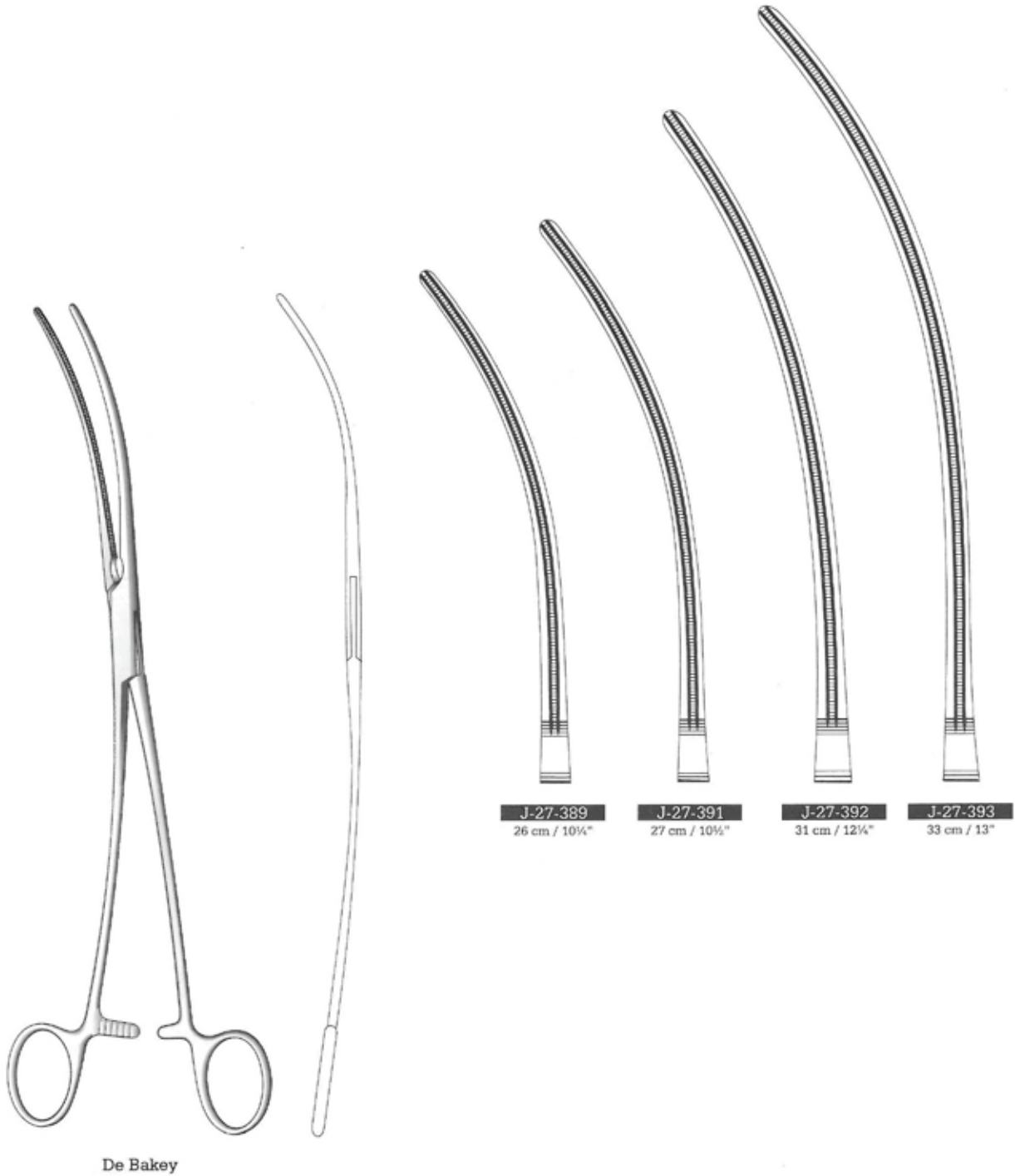



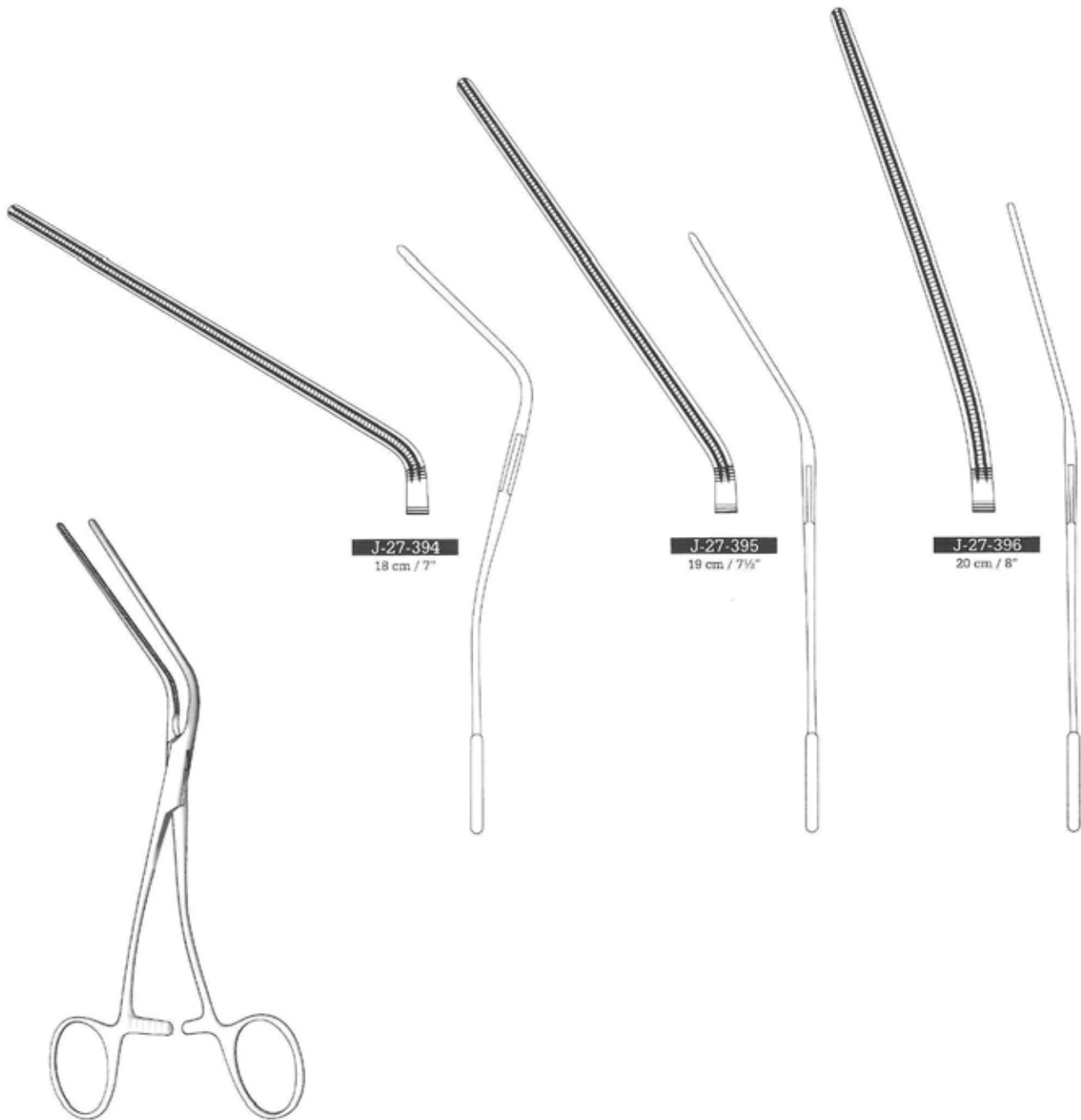

Leland-Jones



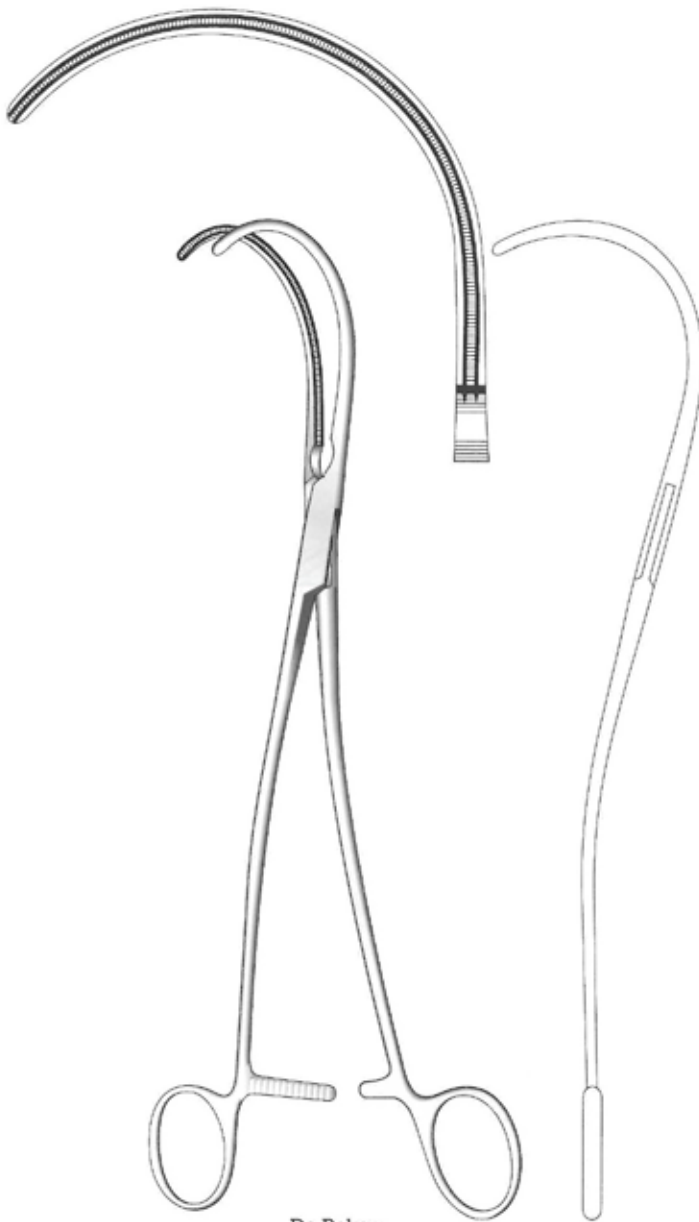

De Bakey  
J-27-401  
25 cm / 10"

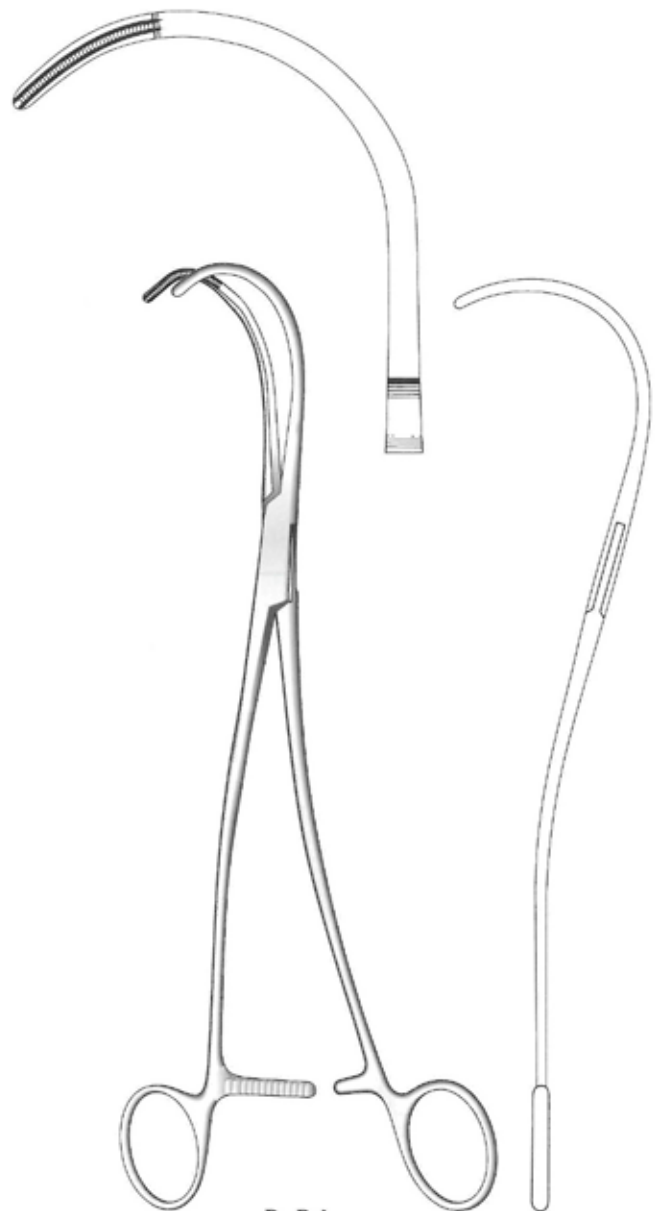

De Bakey  
J-27-402  
25 cm / 10"

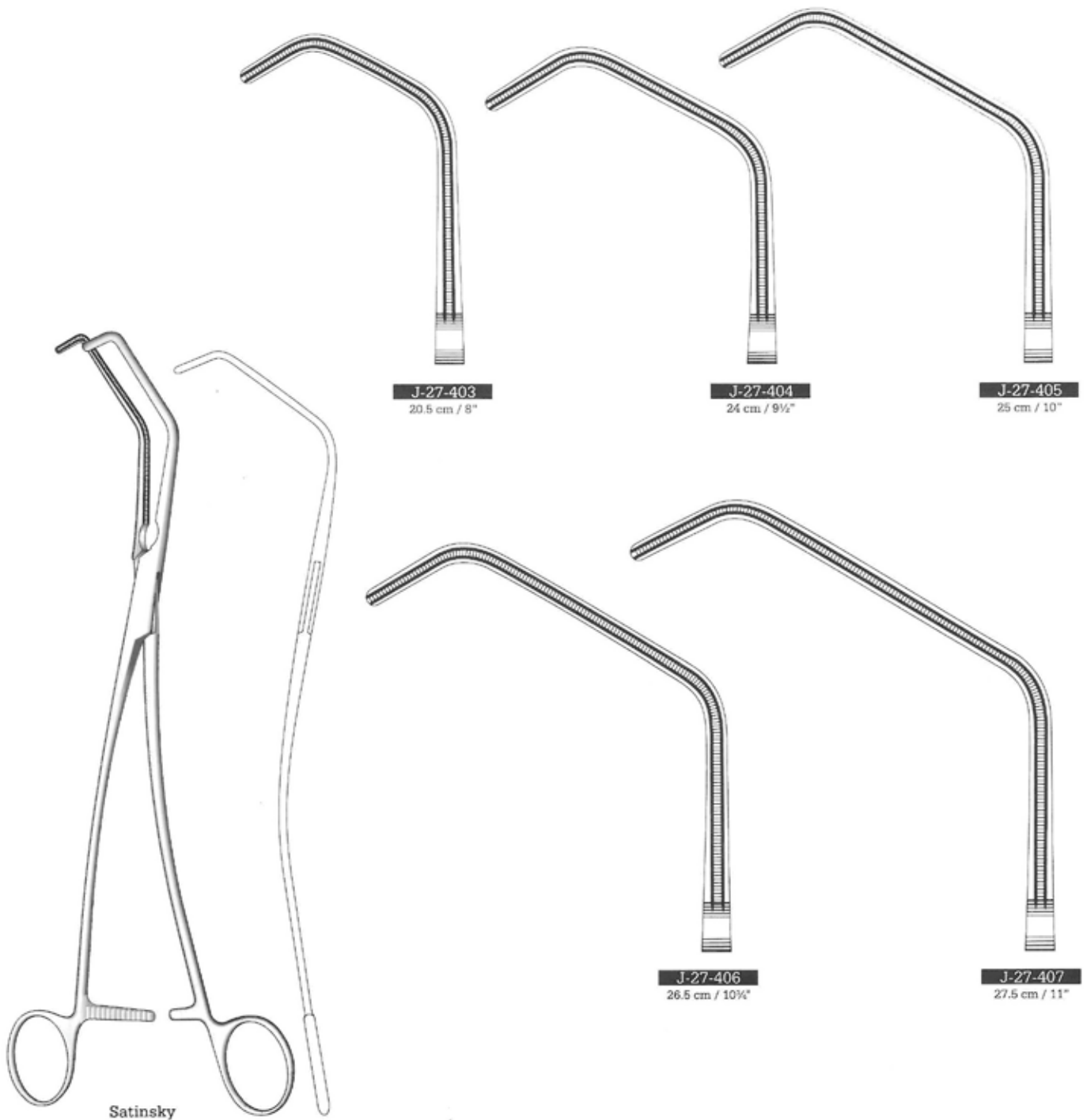

# Cardiovascular Forceps

Auricle Clamps

Aurilcølklemmen

Pirlzas para auricula

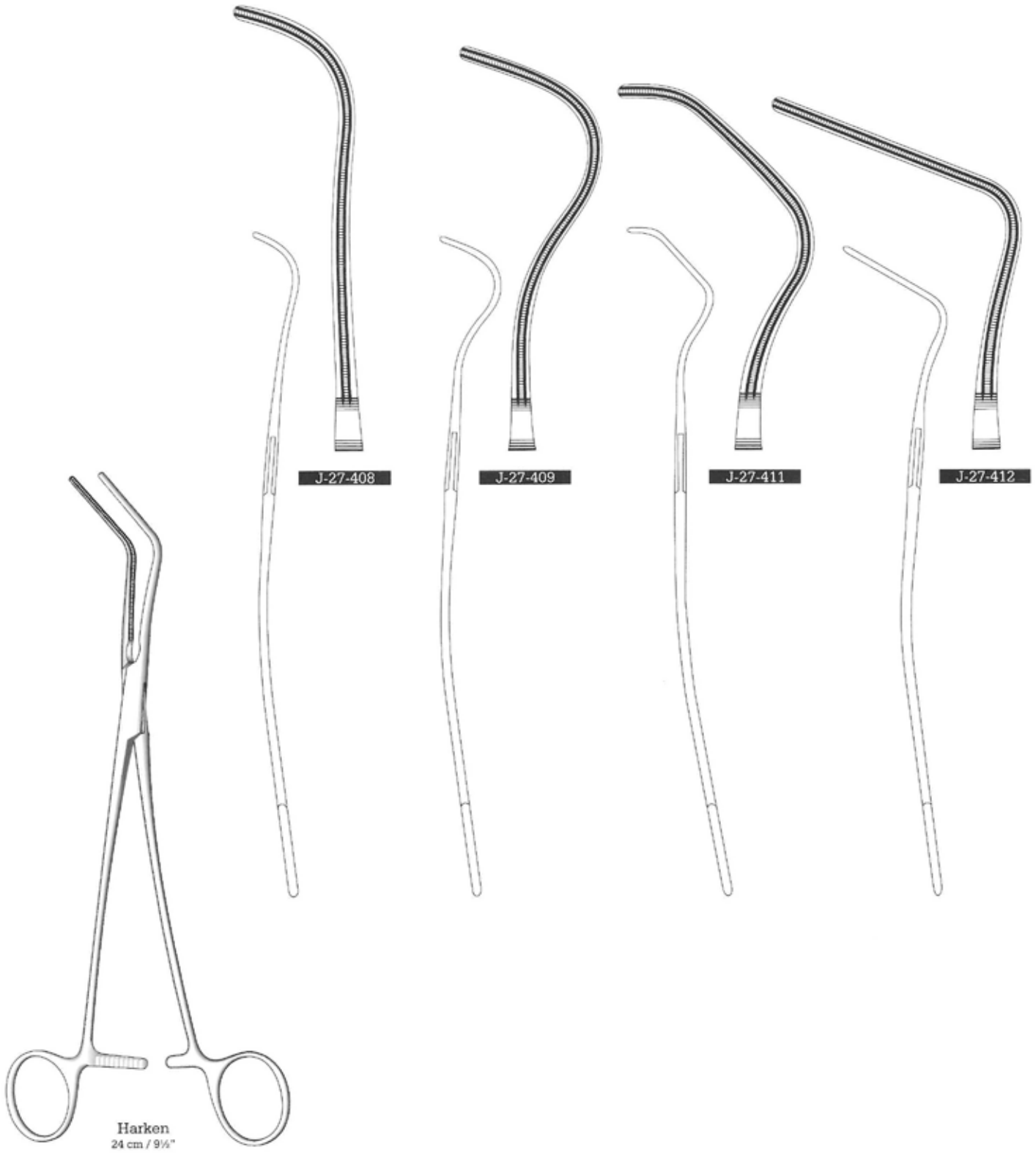

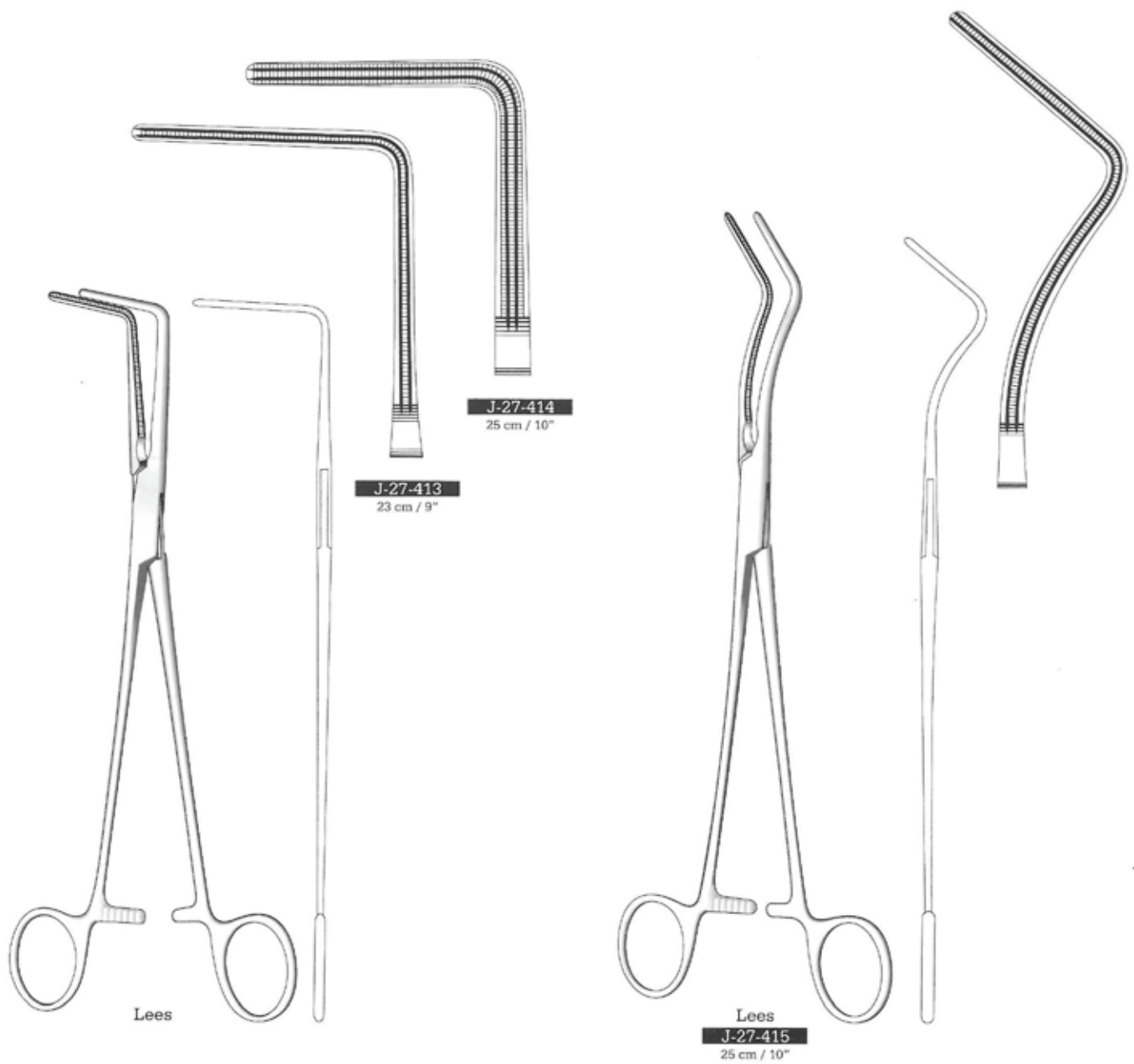



**Cardiovascular Forceps**  
Anastomosis Clamps, Aortic Clamps  
Anastomosenklemmen, Aortaklemmen  
Pirlzas para anastomosis, Pinzas aorticas

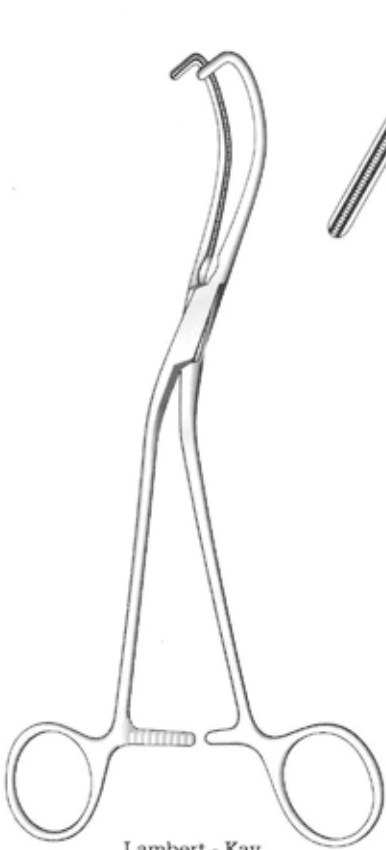

Lambert - Kay



J-27-417



J-27-416

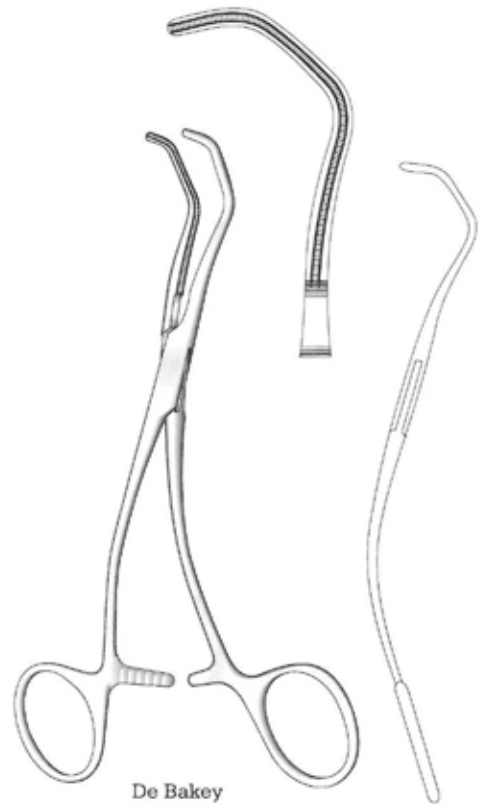

De Bakey  
J-27-418  
17 cm / 6 3/4"

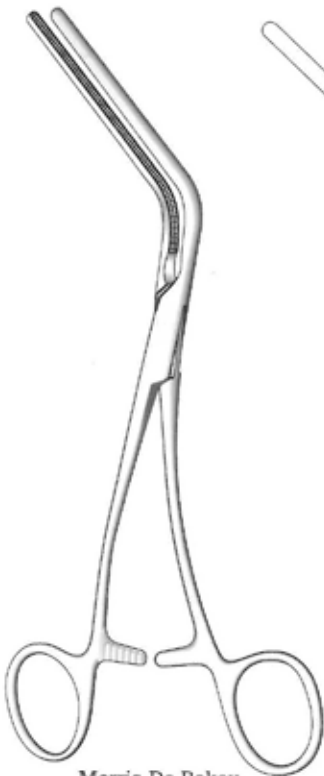

Morris-De Bakey



J-27-419  
18 cm / 7"

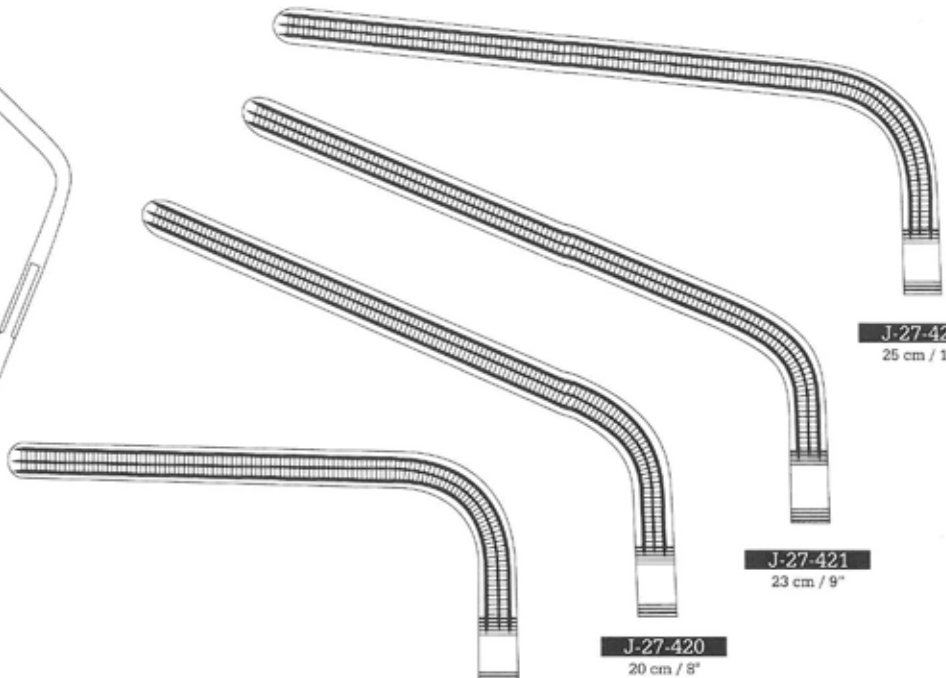

J-27-420  
20 cm / 8"

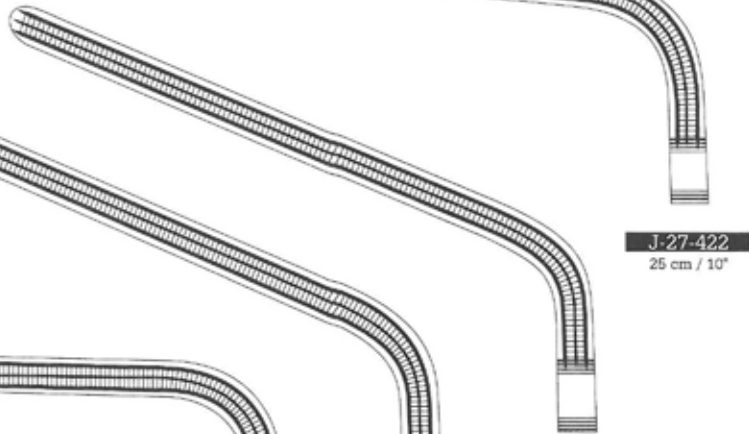

J-27-421  
23 cm / 9"



J-27-422  
25 cm / 10"

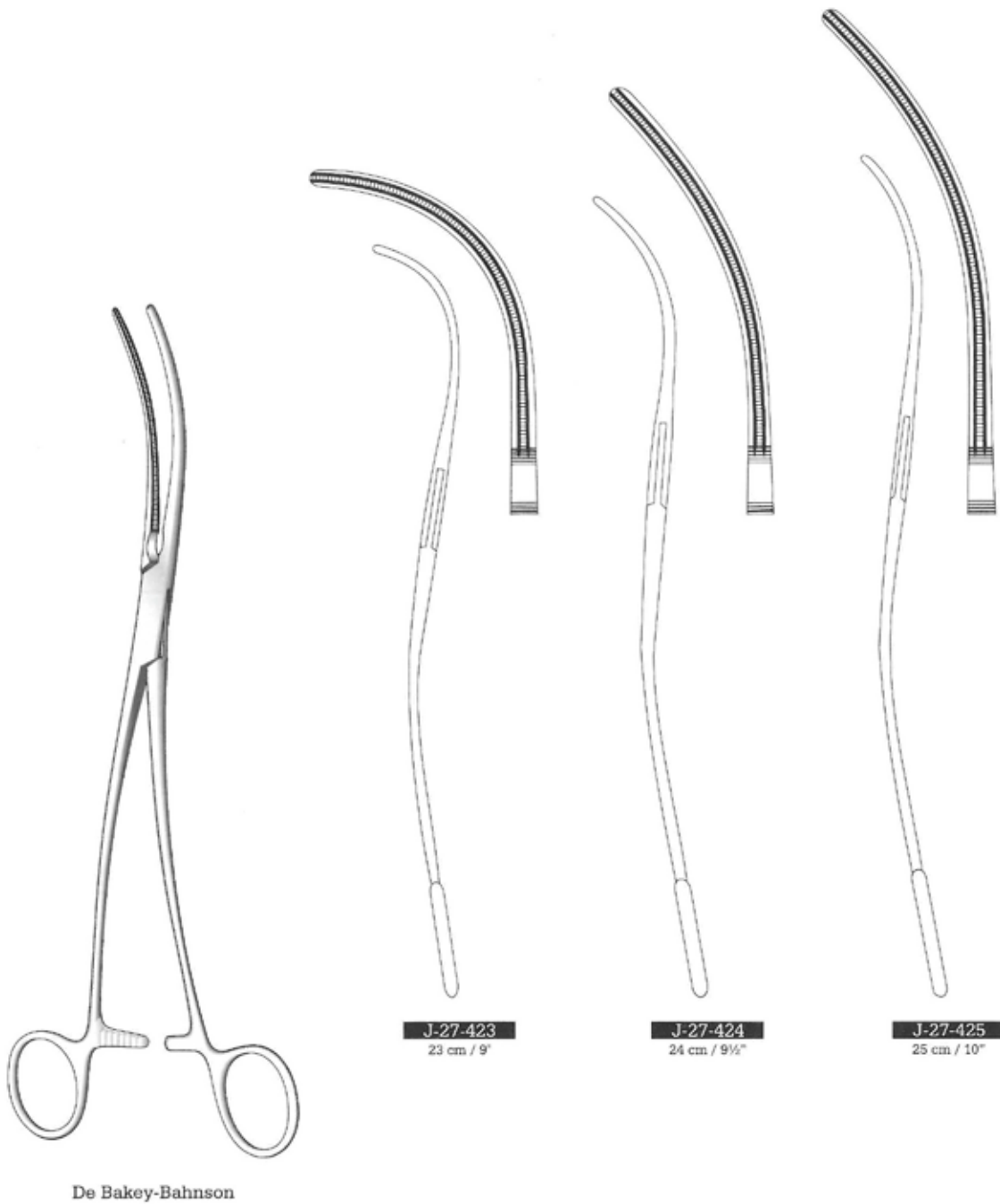

# Cardiovascular Forceps

Neonatal and Pediatric Vascular Clamps, Very Delicate Patterns

Neonatal-und Kinder GefaBklemmen, Extrafeine Modelle

Pinzas-Clamps vasculares para recién nacidos Y pediátricos, Modelos muy delicados

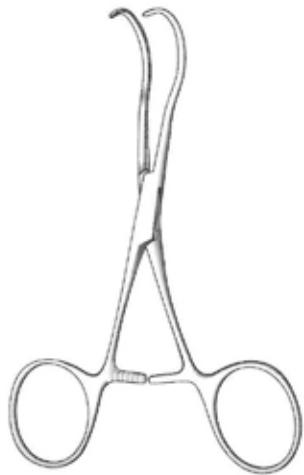

Castaneda



J-27-426  
12 cm / 4 3/4"

J-27-427  
12 cm / 4 3/4"

J-27-428  
12 cm / 4 3/4"

J-27-429  
12 cm / 4 3/4"



J-27-431  
13 cm / 5"

J-27-432  
13 cm / 5"

J-27-433  
11 cm / 4 1/4"

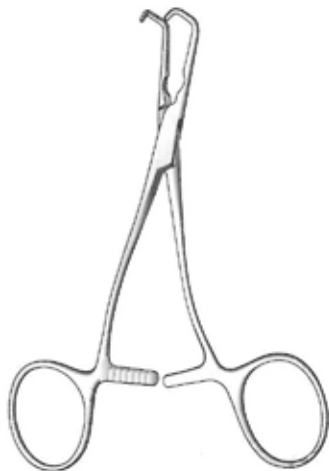

J-27-434  
14 cm / 5 1/2"

J-27-435  
14 cm / 5 1/2"

J-27-436  
14 cm / 5 1/2"

J-27-437  
13 cm / 5"

J-27-438  
14 cm / 5 1/2"



J-27-439  
13 cm / 5"

J-27-441  
13 cm / 5"

J-27-442  
14 cm / 5 1/2"

J-27-443  
13.5 cm / 5 1/4"

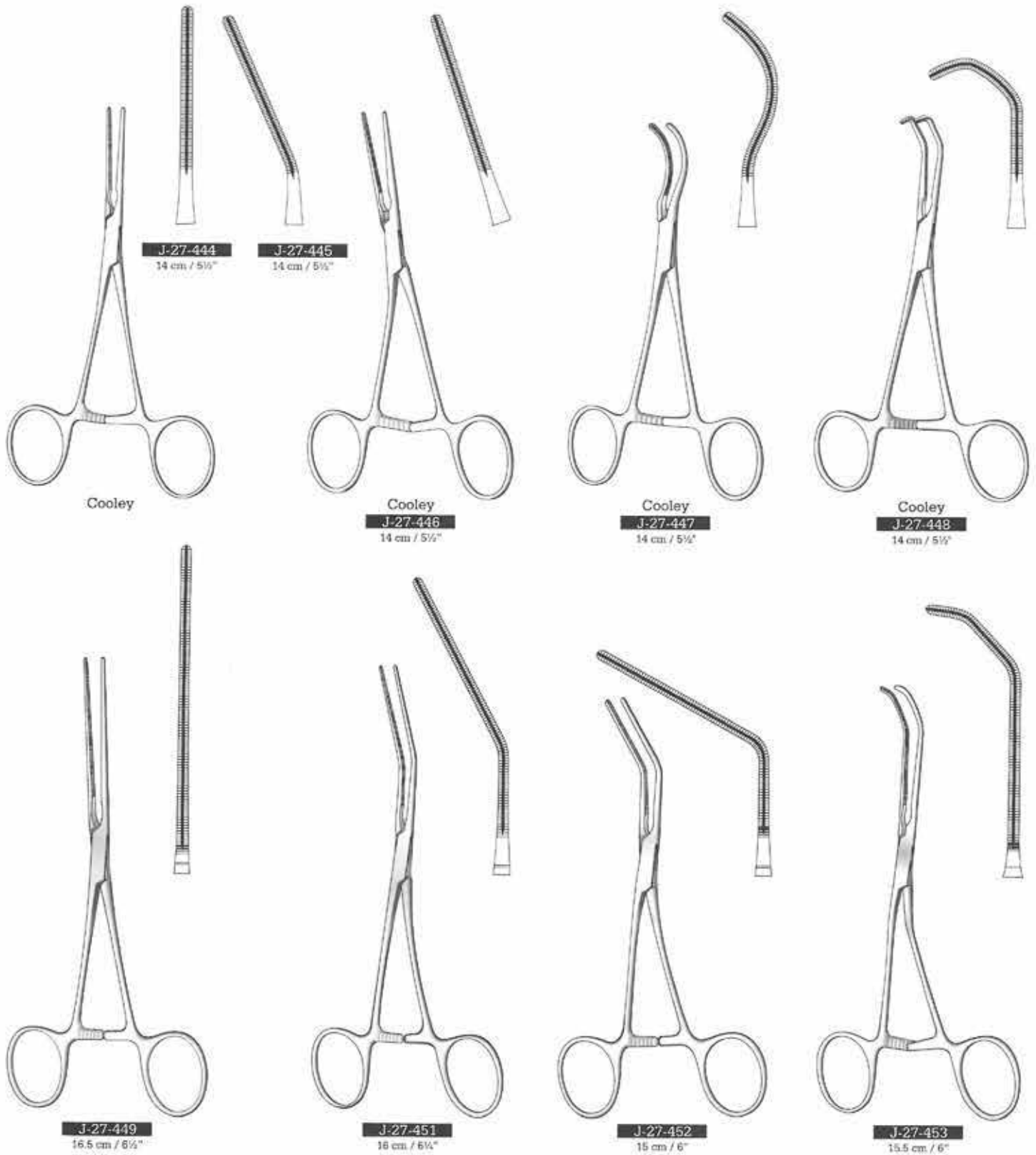

# Cardiovascular Forceps

Anastomosis Clamps  
Arlastomosenklemmen  
Pinzas para anastomosis



Cooley-Derra



J-27-454  
16 cm / 6 1/4"



J-27-455  
17 cm / 6 3/4"



J-27-456  
18 cm / 7"

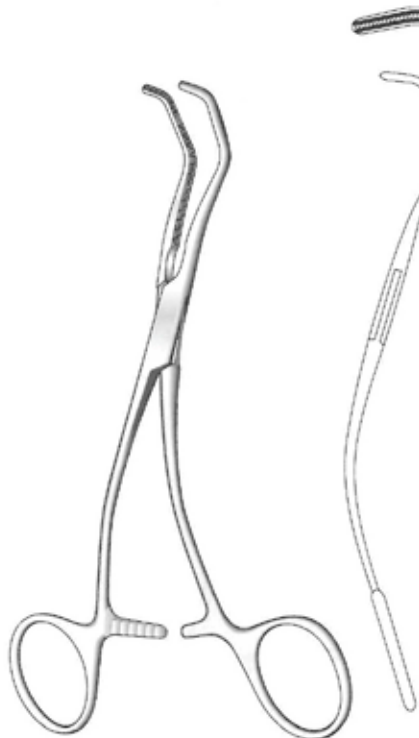

Beck  
J-27-457  
17 cm / 6 3/4"

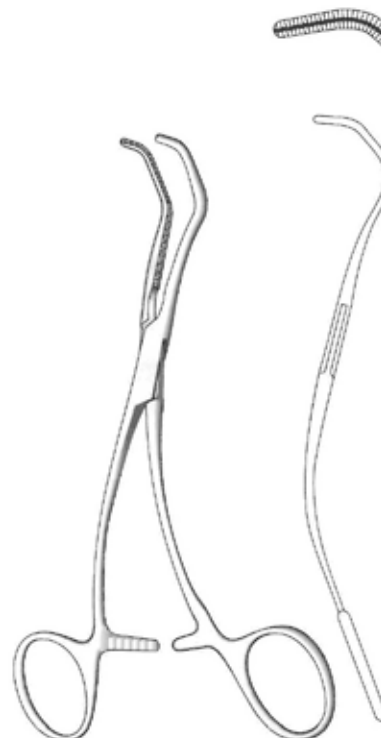

Cooley  
J-27-458  
16 cm / 6 1/2"

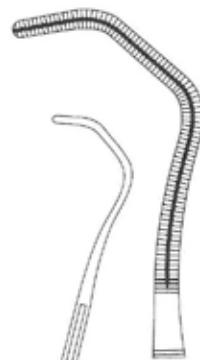

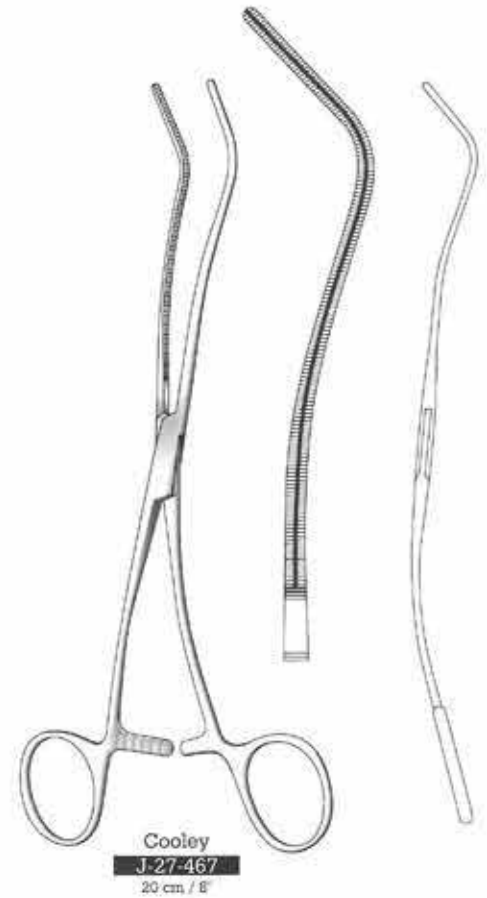
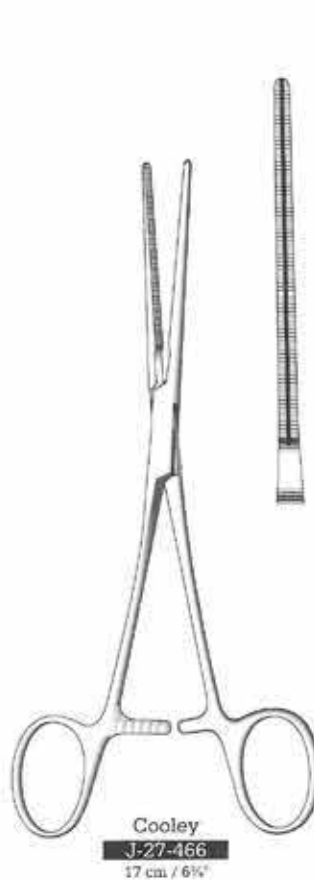
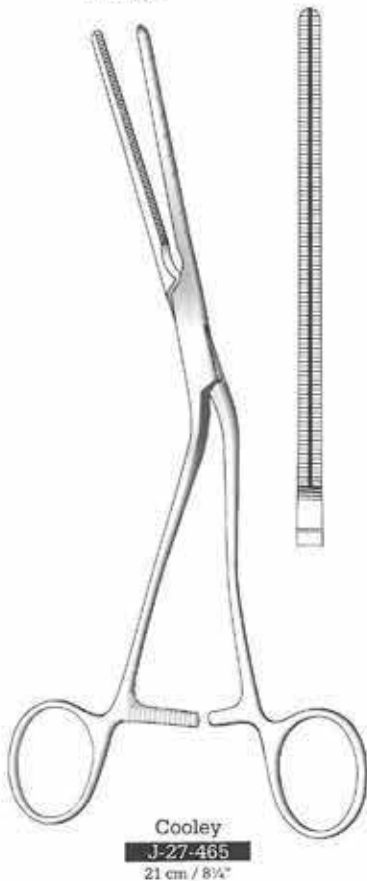
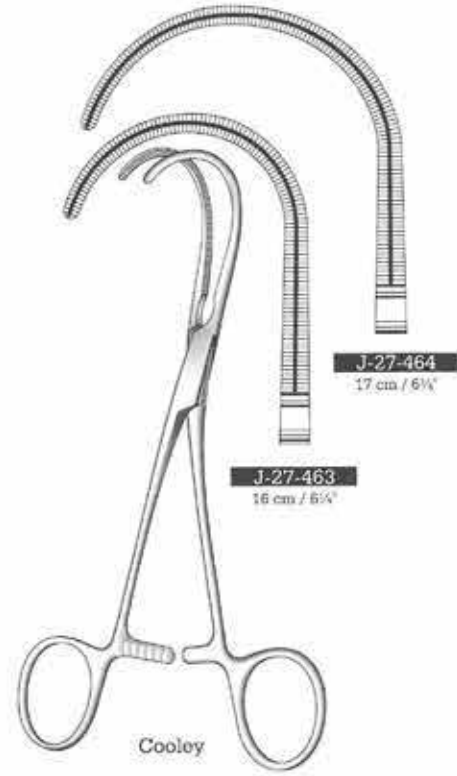



# Cardiovascular Forceps

Anastomosis Clamps, Multi Purpose Vascular Clamps

Anastomosenklemmen, Mehrzweck-Gefäßklemmen

Pinzas para anastomosis, Pinzas vasculares de usos multiples

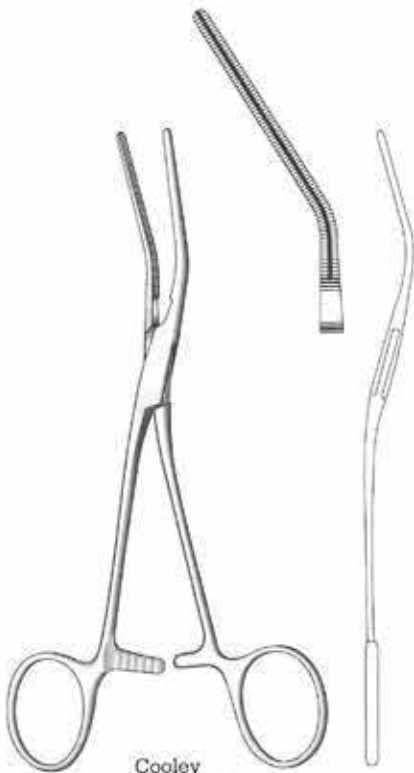

Cooley  
J-27-468  
17 cm / 6 3/4"

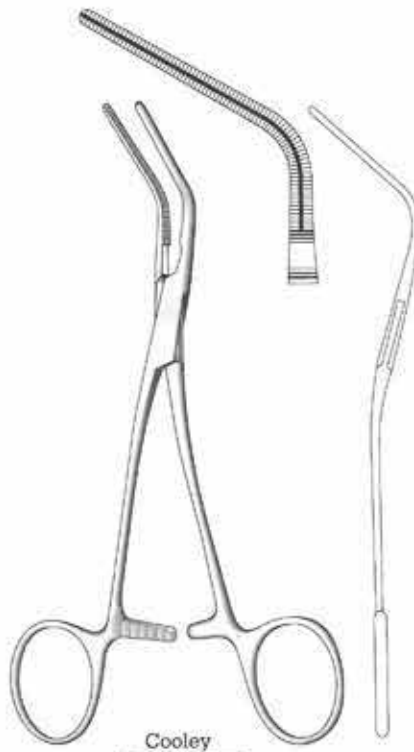

Cooley  
J-27-469  
15 cm / 6"



Cooley  
J-27-471  
15 cm / 6"

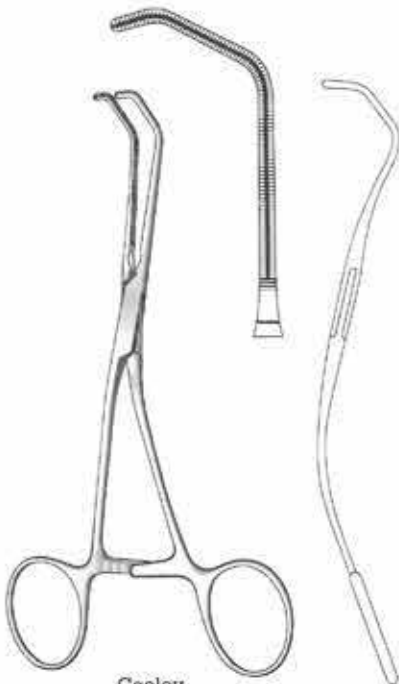

Cooley  
J-27-472  
15 cm / 6"

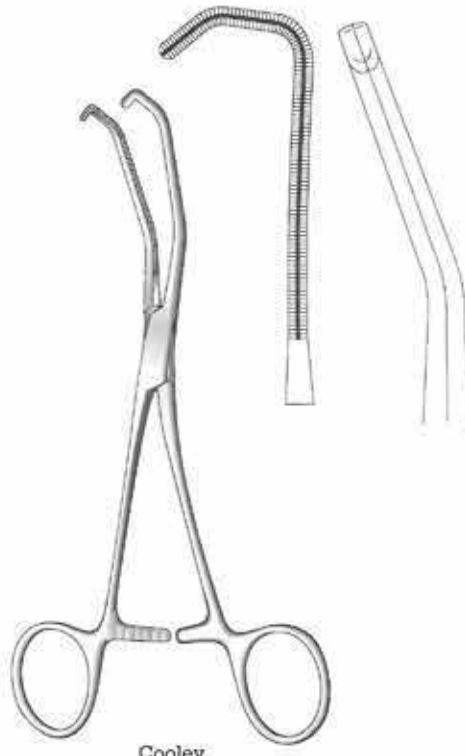

Cooley  
J-27-473  
17 cm / 6 3/4"

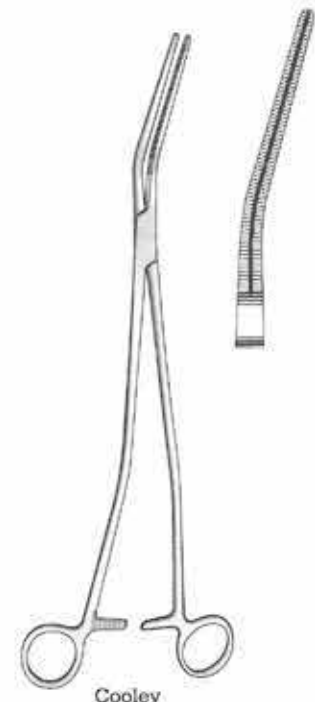

Cooley  
J-27-655  
30 cm / 12"  
7 mm jaws length

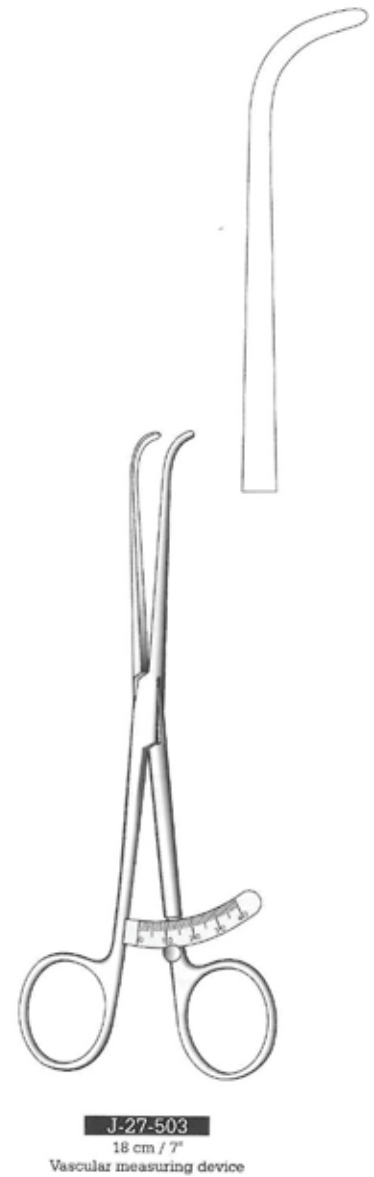
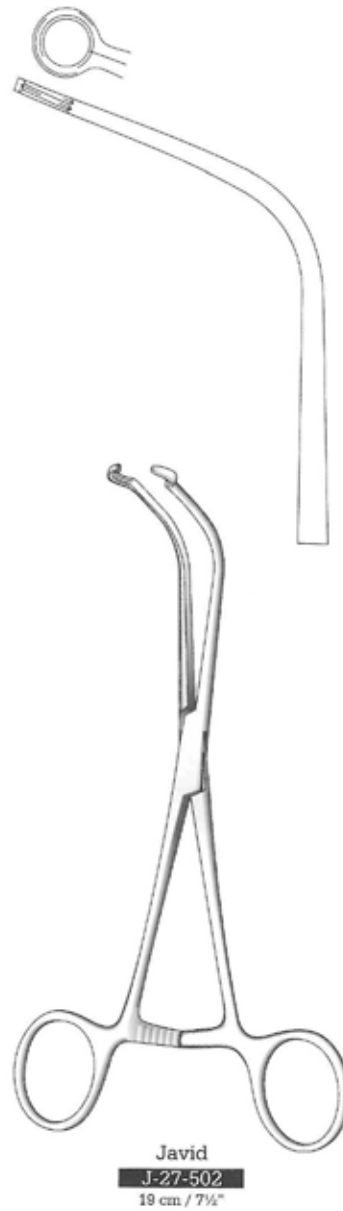
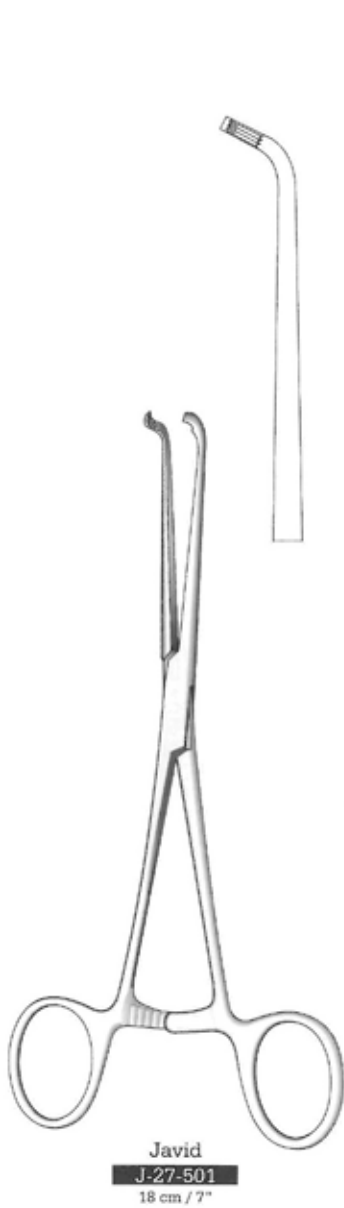

# Vascular Dilator

Vascular Dilators and Intima Spatula, Vascular Dissectors

GefaBdilatatoren und Intimaspatel, GefaBdissektoren

Dilatadores vasculares Y Espatulas para la intima, Disecadores vasculares

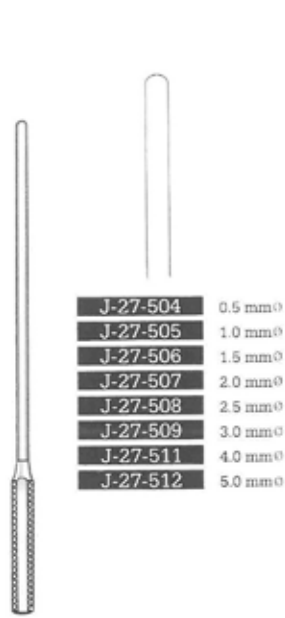

- J-27-504 0.5 mm Ø
- J-27-505 1.0 mm Ø
- J-27-506 1.5 mm Ø
- J-27-507 2.0 mm Ø
- J-27-508 2.5 mm Ø
- J-27-509 3.0 mm Ø
- J-27-511 4.0 mm Ø
- J-27-512 5.0 mm Ø

**Cooley**  
13 cm / 5 1/4"  
Malleable



**De Bakey**  
Malleable



- J-27-514 0.5 mm Ø
- J-27-515 1.0 mm Ø
- J-27-516 1.5 mm Ø
- J-27-517 2.0 mm Ø
- J-27-518 2.5 mm Ø
- J-27-519 3.0 mm Ø
- J-27-521 3.5 mm Ø
- J-27-522 4.0 mm Ø
- J-27-523 4.5 mm Ø
- J-27-524 5.0 mm Ø
- J-27-525 7.0 mm Ø
- J-27-526 9.0 mm Ø



- J-27-528 0.5 mm Ø
- J-27-529 1.0 mm Ø
- J-27-531 1.5 mm Ø
- J-27-532 2.0 mm Ø
- J-27-533 2.5 mm Ø
- J-27-534 3.0 mm Ø
- J-27-535 3.5 mm Ø
- J-27-536 4.0 mm Ø
- J-27-537 4.5 mm Ø
- J-27-538 5.0 mm Ø
- J-27-539 7.0 mm Ø
- J-27-540 9.0 mm Ø

19 cm / 7 1/2"

35 cm / 14"



3 mm  
Blunt



Blunt

- J-27-541 18.5 cm / 7 1/4"
- J-27-542 21.5 cm / 8 1/4"

- J-27-543 14 cm / 5 1/2"
- J-27-544 23 cm / 9"



5 mm



2.5 mm Ø

**Robb**  
J-27-555  
24 cm / 9 1/2"  
Fig. 1



4 mm



2.0 mm Ø

**Robb**  
J-27-556  
24 cm / 9 1/2"  
Fig. 2



3 mm



1.5 mm Ø

**Robb**  
J-27-557  
24 cm / 9 1/2"  
Fig. 3

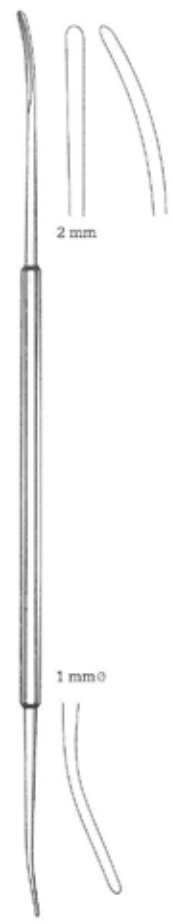

2 mm



1 mm Ø

**Robb**  
J-27-558  
24 cm / 9 1/2"  
Fig. 4

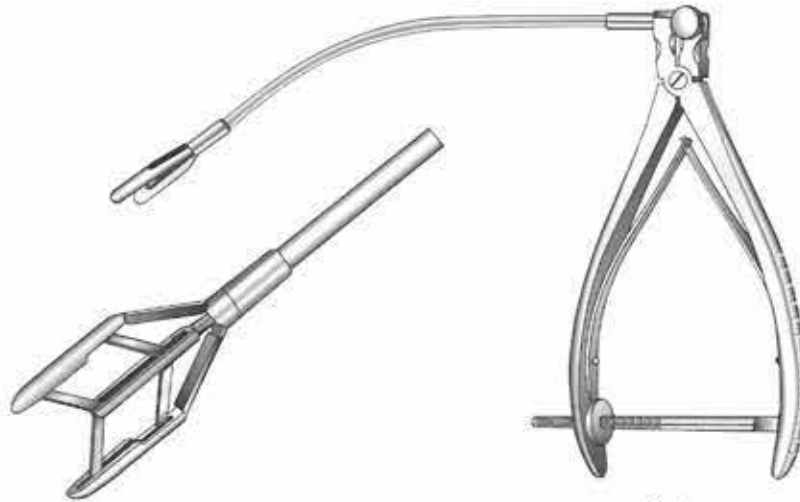

Cooley

J-27-475

Blade opening from 8-15 mm  
With thread fixation

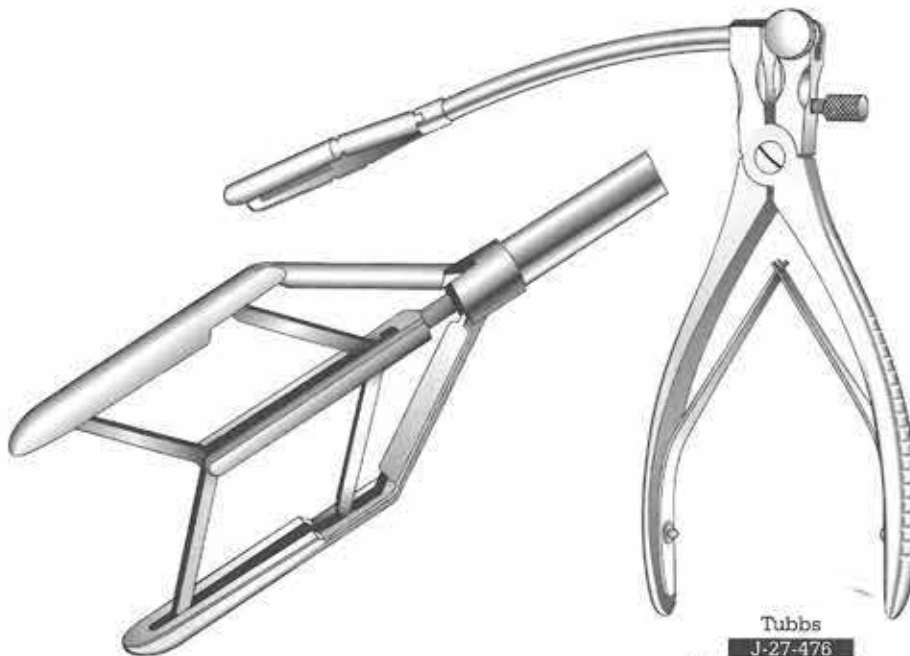

Tubbs

J-27-476

Blade opening from 6-42 mm  
With fixation screw