





OTOLOGY, RHINOLOGY, ORAL INSTRUMENTS, TONSILS

 www.convertualinterlogic.com

 +234 8033200998
+234 8180003461

 enquiries@convertualinterlogic.com

 1 Anu Crescent, Off Ado-Badore Road,
Ajah, Lagos, Nigeria

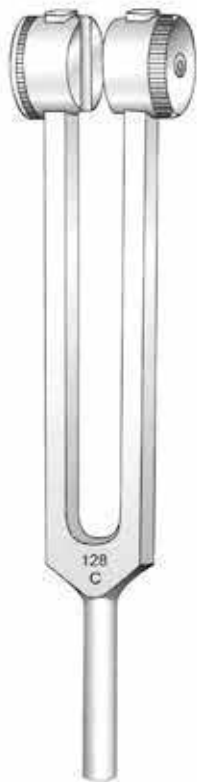

Surgicon-Alloy
J-31-002
C 128



Surgicon-Alloy
J-31-003
C 256

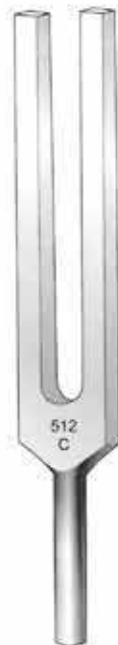

Surgicon-Alloy
J-31-004
C 512



Surgicon-Alloy
J-31-005
C 1024



Surgicon-Alloy
J-31-006
C 2048

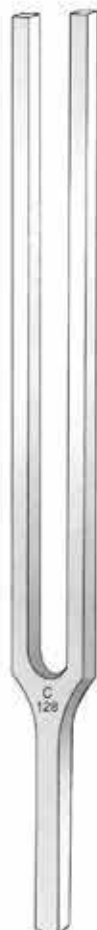

Hartmann
J-31-007
C 128



Hartmann
J-31-008
C 256



Hartmann
J-31-009
C 512



Hartmann
J-31-011
C 1024



Hartmann
J-31-012
C 2048



Hartmann
J-31-013
C 4096

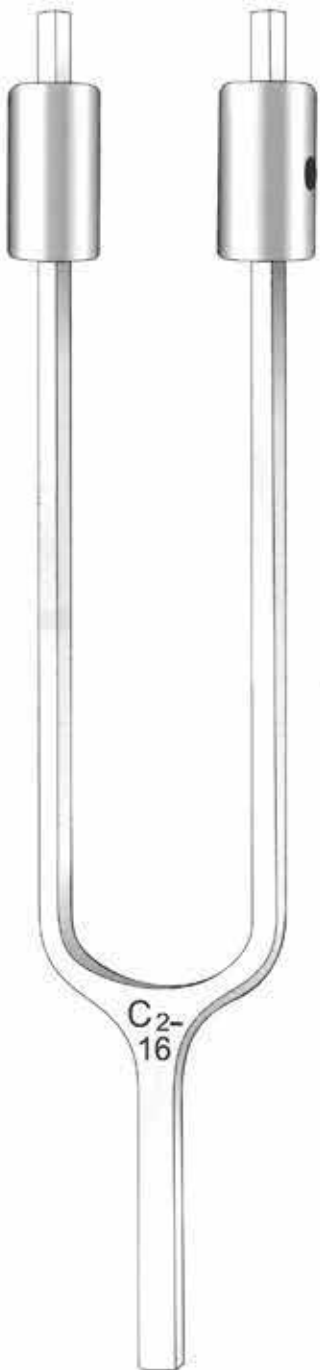

French
J-31-021
C, 16



French
J-31-022
C, 32



Hartmann
J-31-023
C 64



Hartmann
J-31-024
C 128



Hartmann
J-31-025
C' 256

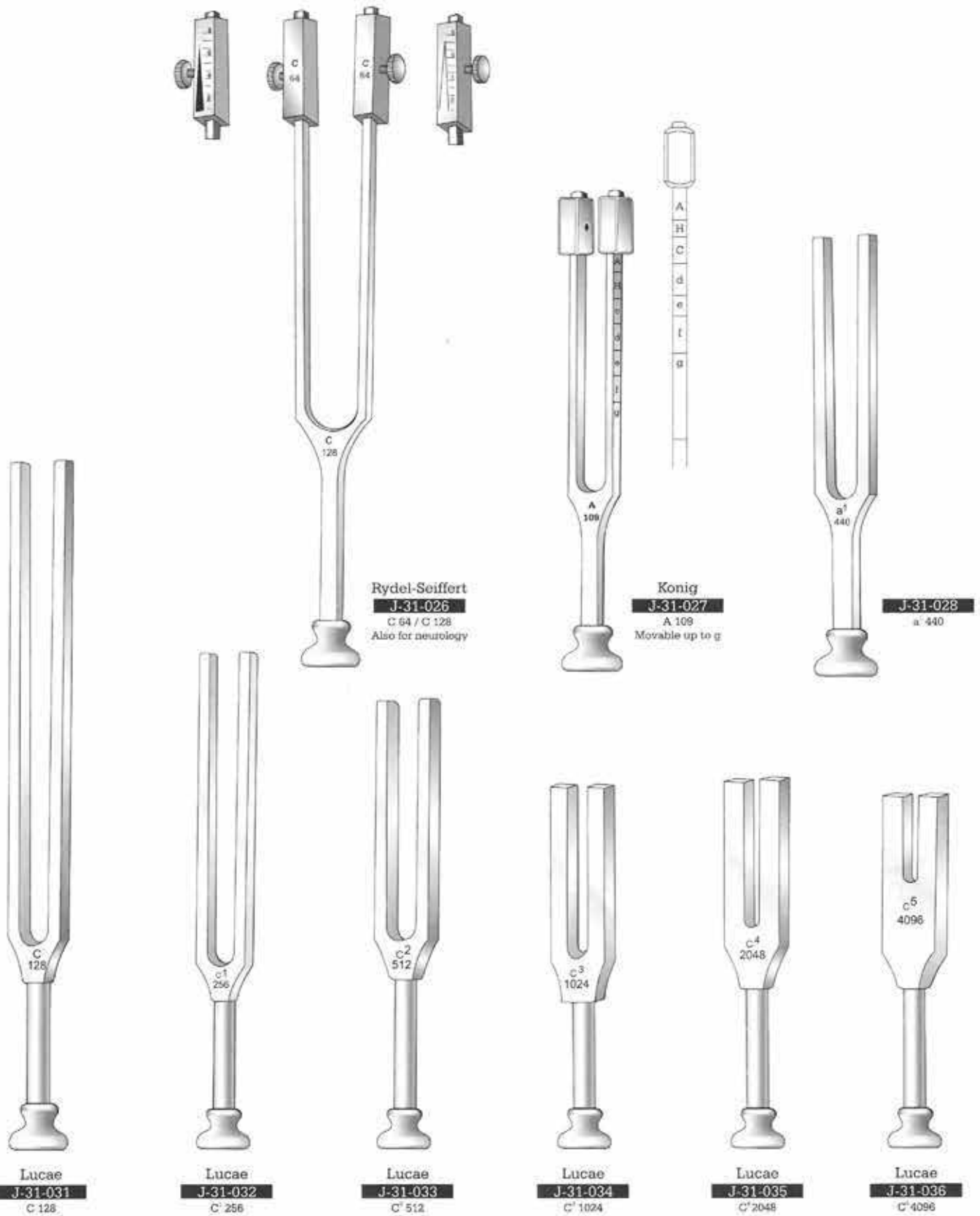



Troeltsch
J-31-015
 Set of 3



J-31-016
 6 mm \varnothing
 Fig.1



J-31-017
 7 mm \varnothing
 Fig.2



J-31-018
 8 mm \varnothing
 Fig.3



Hartmann
J-31-042
 Set of 5



J-31-041
 3 mm \varnothing
 Fig.1



J-31-040
 4 mm \varnothing
 Fig.2



J-31-043
 5 mm \varnothing
 Fig.3



J-31-044
 6 mm \varnothing
 Fig.4



J-31-045
 7 mm \varnothing
 Fig.5



Hartmann
J-31-065
 Set of 4



J-31-060
 4.5 mm \varnothing
 Fig.1



J-31-070
 5.5 mm \varnothing
 Fig.2



J-31-080
 6.5 mm \varnothing
 Fig.3



J-31-081
 7.5 mm \varnothing
 Fig.4



Toynbee
J-31-095
 Set of 4



J-31-090
 4.5 mm \varnothing
 Fig.1



J-31-100
 5.5 mm \varnothing
 Fig.2



J-31-110
 6.5 mm \varnothing
 Fig.3



J-31-111
 7.5 mm \varnothing
 Fig.4



Poltzer
J-31-125
 Set of 4



J-31-120
 3 mm \varnothing
 Fig.1



J-31-130
 4.5 mm \varnothing
 Fig.2



J-31-140
 5.5 mm \varnothing
 Fig.3



J-31-141
 6.5 mm \varnothing
 Fig.4



Pritchard
J-31-155
 Set of 3



J-31-150
 4.5 mm \varnothing
 Fig.1



J-31-160
 6.5 mm \varnothing
 Fig.2



J-31-170
 7.5 mm \varnothing
 Fig.3



Erhardt
J-31-175 Round
J-31-205 Oval
 Set of 3



J-31-180
 4.5 mm \varnothing
 Fig.1



J-31-207
 4.5 mm \varnothing
 Fig.1



J-31-190
 5.5 mm \varnothing
 Fig.2



J-31-208
 5.5 mm \varnothing
 Fig.2



J-31-200
 6.5 mm \varnothing
 Fig.3



J-31-209
 6.5 mm \varnothing
 Fig.3



Gruber
J-31-212 Round
J-31-214 Oval
 Set of 4



J-31-210
 4.5 mm \varnothing
 Fig.1



J-31-222
 4.5 mm \varnothing
 Fig.1



J-31-220
 5.5 mm \varnothing
 Fig.2



J-31-224
 5.5 mm \varnothing
 Fig.2



J-31-216
 6.5 mm \varnothing
 Fig.3



J-31-226
 6.5 mm \varnothing
 Fig.3



J-31-218
 7.5 mm \varnothing
 Fig.4



J-31-228
 7.5 mm \varnothing
 Fig.4

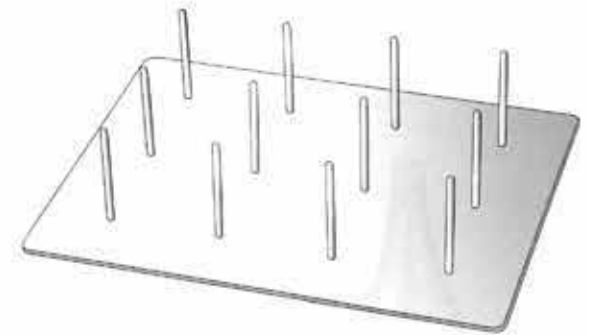
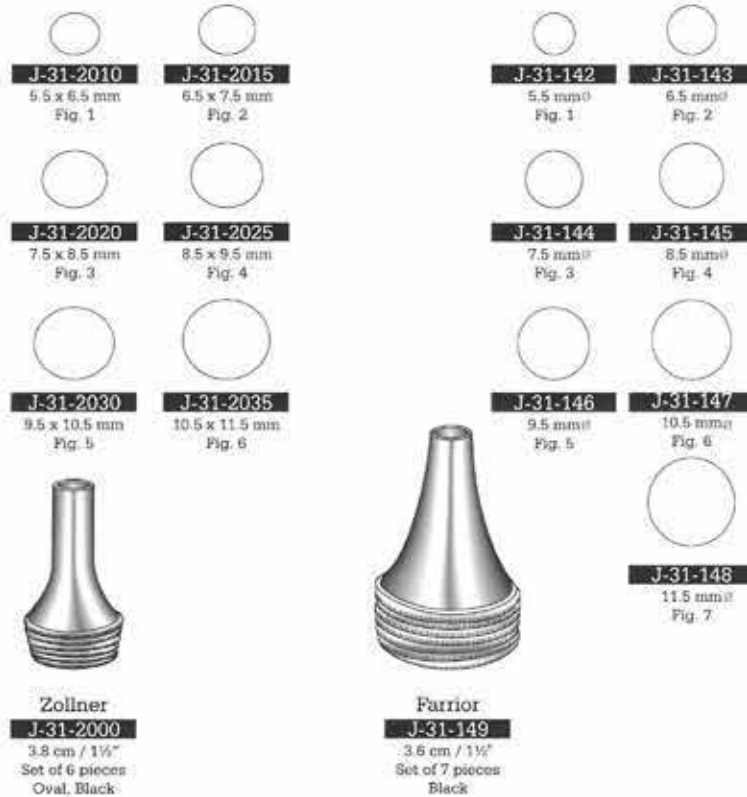

J-31-245
Ear specula storage rack

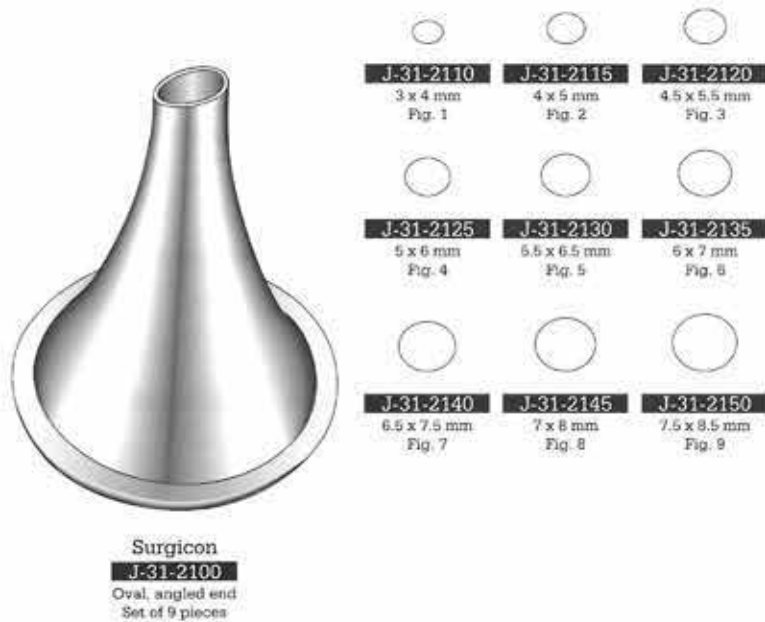

Otology

Specula and Syringes-Eustachian Catheters
 Spekula und Spitzten— Ohrkatheter
 Especulos y Jeringas Sondas auriculares

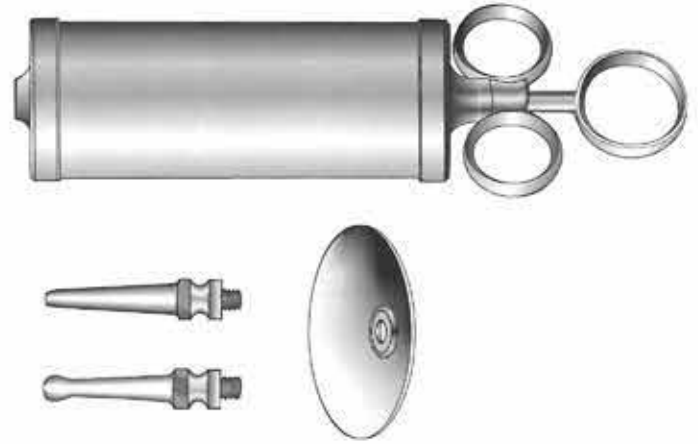
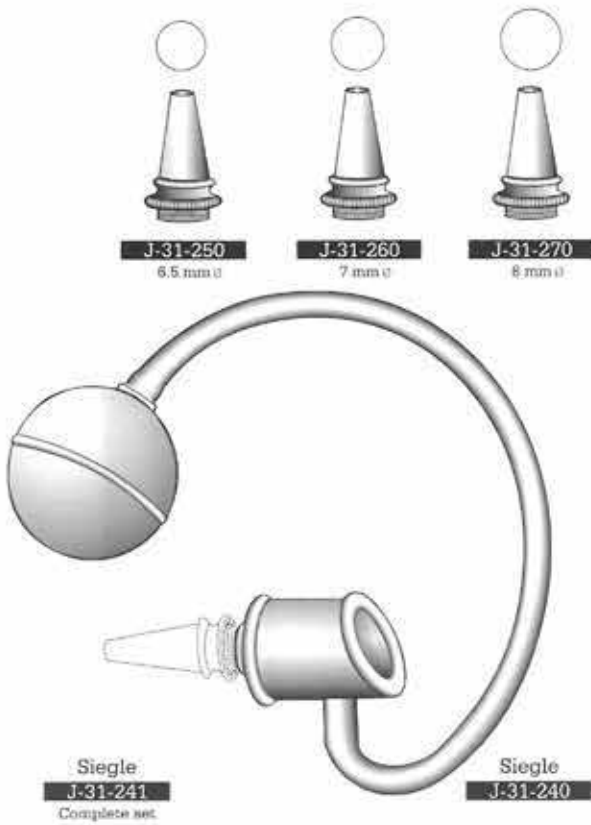

Pimeroy

J-31-280	50 c.c.
J-31-290	75 c.c.
J-31-300	100 c.c.
J-31-310	150 c.c.
J-31-320	200 c.c.

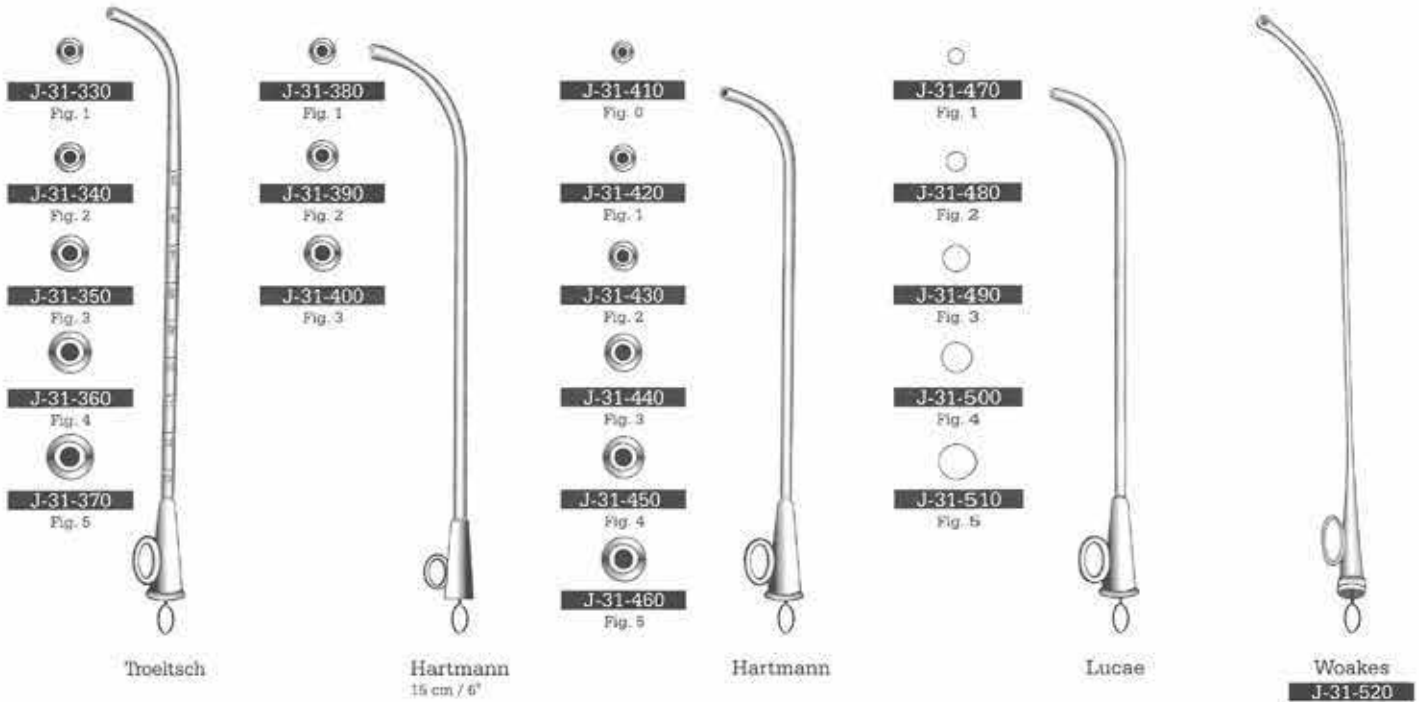

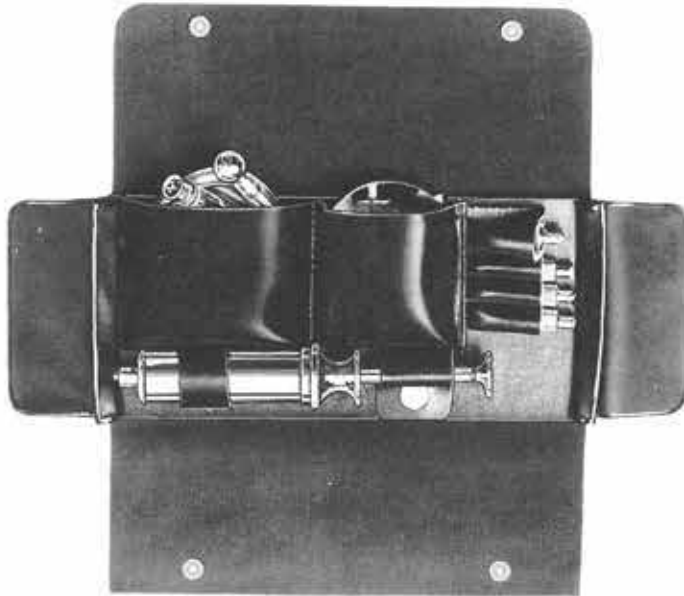

J-31-2200
Ear syringe, complete
self filling in plastic pouch

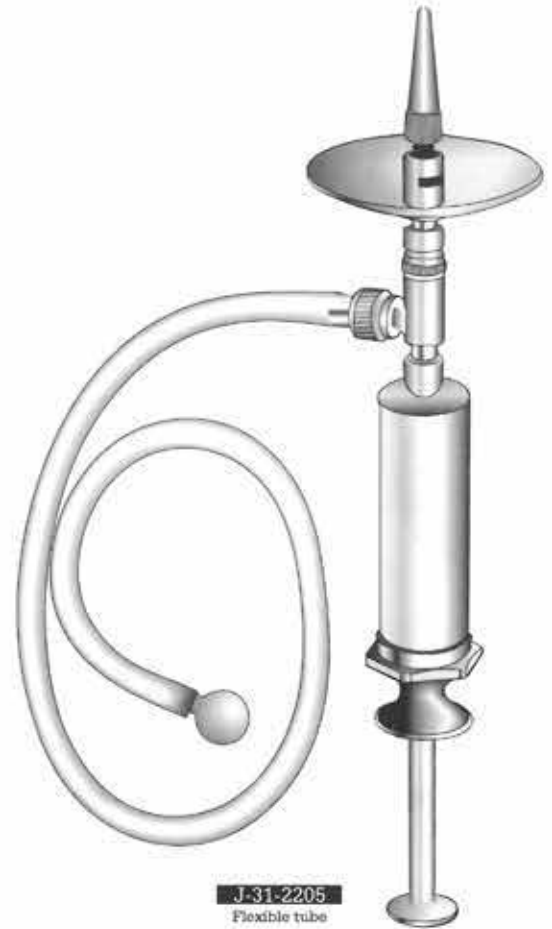

J-31-2205
Flexible tube

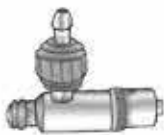

J-31-2210
Valve attachment



J-31-2215
Suction nozzle



J-31-2220
Protecting disc



J-31-2225
Metal olive



J-31-2230
Conical tip



J-31-2235
Button ended tip



J-31-2240
Threaded tip



J-31-2250 50 ml
J-31-2260 75 ml
J-31-2270 100 ml
Ear syringe, complete with
protecting disc and 2 tips





J-31-2305
Connecting nozzle



J-31-2310
4 mm \varnothing
Rat olive



J-31-2315
15 mm \varnothing
Nose olive



J-31-2320
17 mm \varnothing
Nose olive



J-31-2325
22 mm \varnothing
Nose olive



Poltizer
J-31-2300
J-31-2301 Complete set

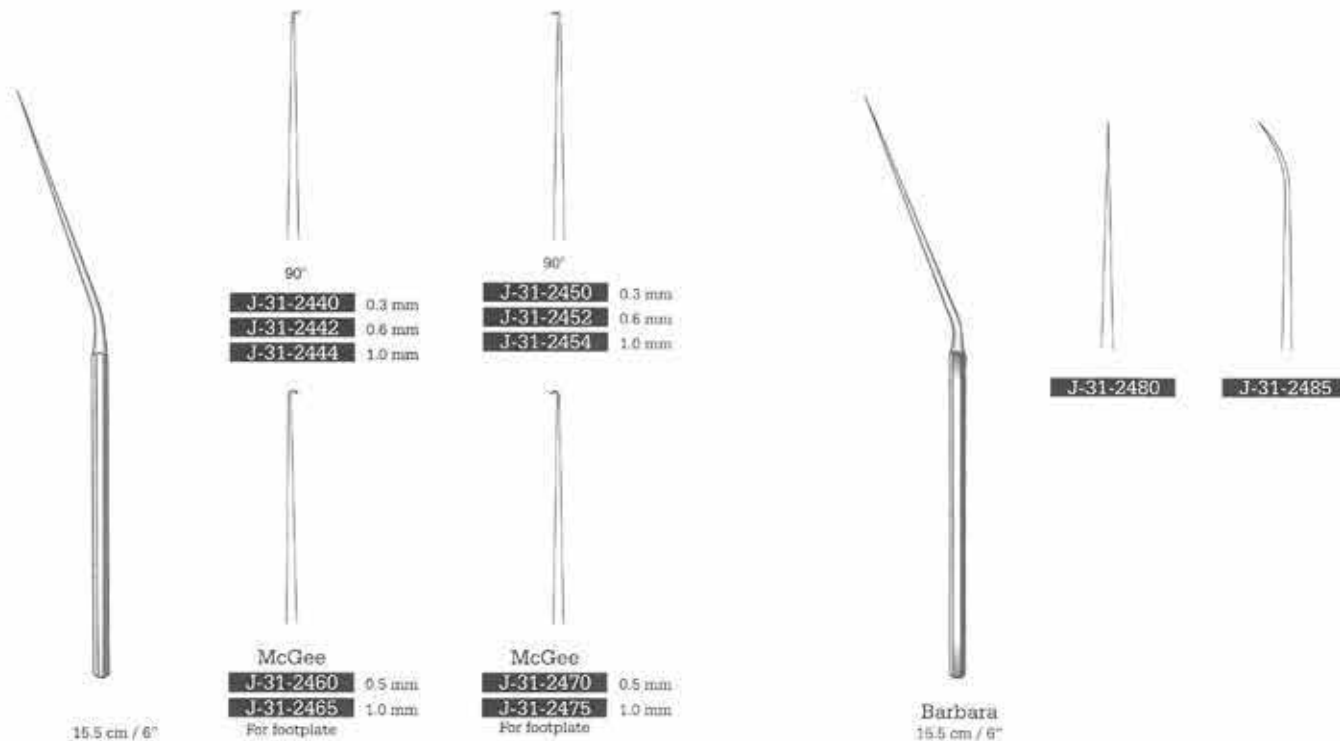
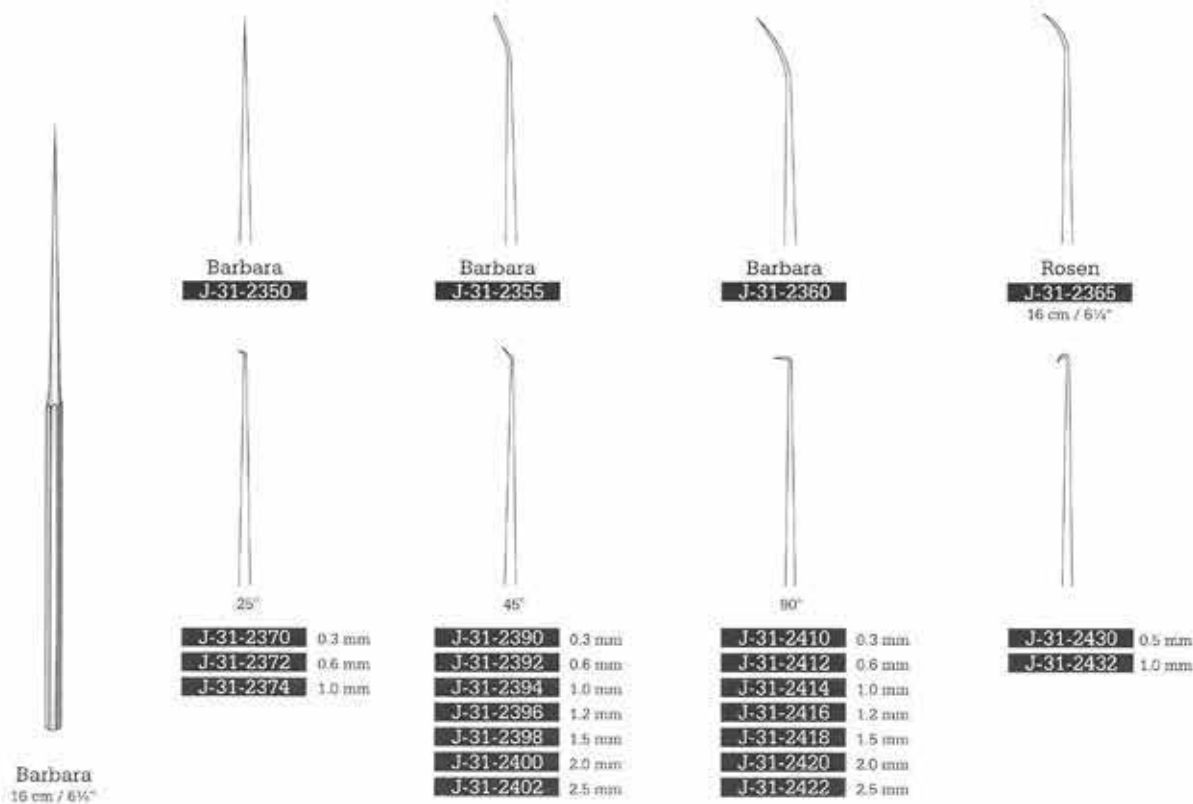



House
14.5 cm / 5 3/4"



J-31-2590
1.0 / 1.2 mm



J-31-2595
1.5 / 1.8 mm



House
14.5 cm / 5 3/4"



J-31-2600
1.0 / 1.2 mm



J-31-2605
1.5 / 1.8 mm



Langenbeck
J-31-2610
13 cm / 5"
Blunt



Shapleigh
15 cm / 6"
Rare curette
Delicate



J-31-2615
2.5 mm



J-31-2620
3.5 mm



Jansen
J-31-2630
17 cm / 6 3/4"
Sharp



Politzer
J-31-2640
14.5 cm / 5 3/4"
Paruncle knife



Politzer
J-31-2650
17.5 cm / 7"

Otology

Micro Ear Knives

Mikro-Ohrmesser

Micro cuchillos auriculares



Schuknecht
J-31-2660
Rotary knife



Schuknecht
J-31-2670
14.5 cm / 5 7/8"
Sickle knife



Wullstein
J-31-2680
15.5 cm / 6"
Sickle knife



Tabb
J-31-2690
Mucosa knife



Plester
J-31-2700
15 cm / 6"
Flap knife



Rosen
15 cm / 6"
Circular cut knives



J-31-2710
1 mm Ø
Fig. 7



J-31-2715
1.4 mm Ø
Fig. 6



J-31-2720
1.6 mm Ø
Fig. 5



J-31-2725
2 mm Ø
Fig. 4



J-31-2730
2.6 mm Ø
Fig. 3



J-31-2735
2.8 mm Ø
Fig. 2



J-31-2740
3 mm Ø
Fig. 1



Otology

Foreign Body Instruments

Fremdkörperinstrumente

Instrumentos para cuerpos extraños



Weber-Loch
J-31-2760
16.5 cm / 6 1/2"
Ear loop



Moldenhauer
J-31-2770
15.5 cm / 6"
Foreign body lever



Zaufal
J-31-2780
15 cm / 6"
Foreign body lever



Hartmann
J-31-2790
18 cm / 6 3/4"
Sharp, ear hooklet

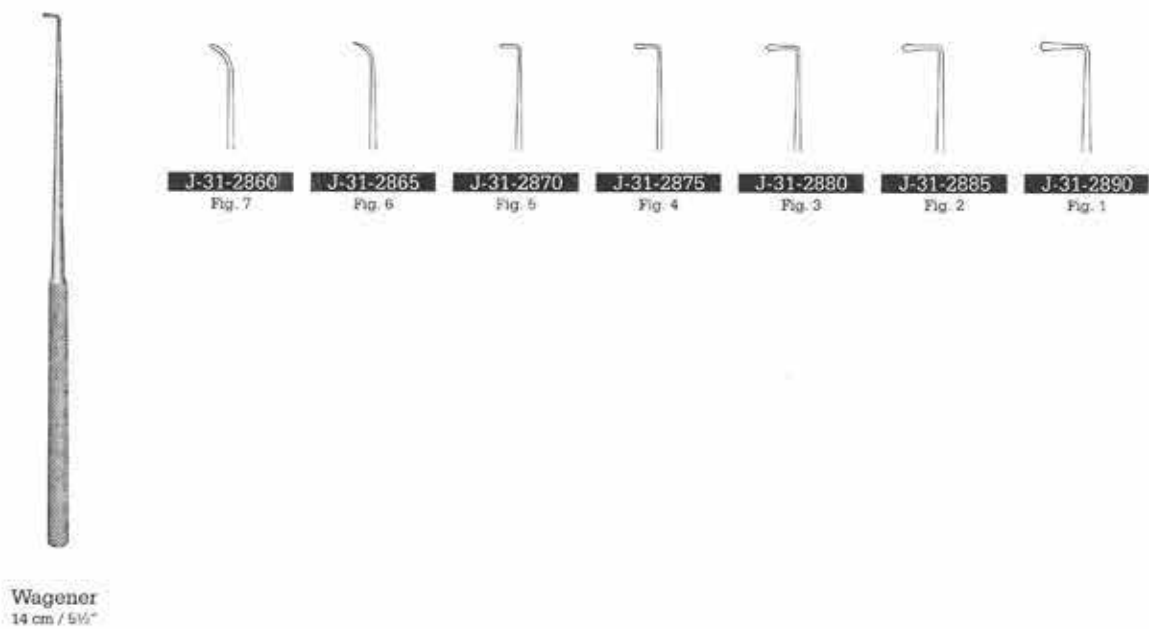
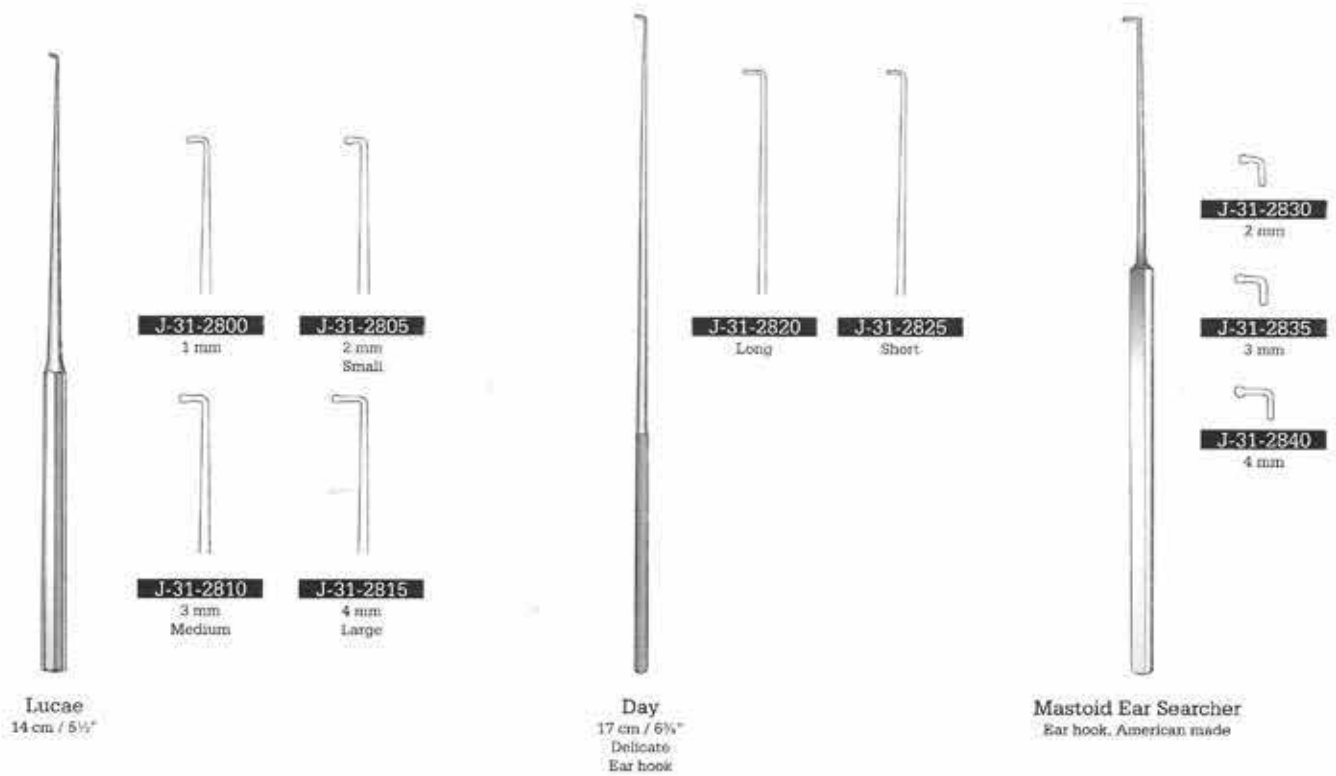

Otology

Ear Periosteal Elevators, Ear Scoops

Ohrraspatofien, Ohrloeffel

Legras auriculaxes, Cucharillas auriculares



Lempert
J-31-2900
20.5 cm / 8"
6 mm



Lempert
J-31-2910
18 cm / 7"
6 mm



Lempert
21.5 cm / 8 1/2"
Sharp

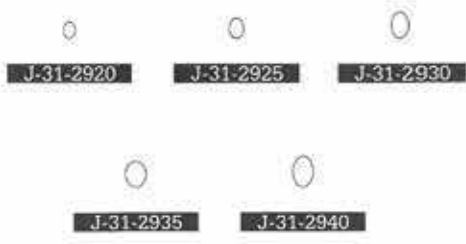



Buck
16.5 cm / 6 1/2"

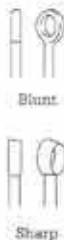









				
	Fig. 000	Fig. 00	Fig. 0	Fig. 1
Blunt	J-31-670	J-31-680	J-31-690	J-31-700
Sharp	J-31-750	J-31-760	J-31-770	J-31-780
				
	Fig. 2	Fig. 3	Fig. 4	Fig. 5
Blunt	J-31-710	J-31-720	J-31-730	J-31-740
Sharp	J-31-790	J-31-800	J-31-810	J-31-820



















Buck
16.5 cm / 6 1/2"
extra extra fine

	J-31-830	Fig. 000
	J-31-840	Fig. 00
	J-31-850	Fig. 0
	J-31-860	Fig. 1
	J-31-870	Fig. 2
	J-31-880	Fig. 3
	J-31-890	Fig. 4
	J-31-900	Fig. 5
	Round handle	
	Blunt	
	J-31-910	Fig. 000
	J-31-920	Fig. 00
	J-31-930	Fig. 0
	J-31-940	Fig. 1
	J-31-950	Fig. 2
	J-31-960	Fig. 3
	J-31-970	Fig. 4
	J-31-980	Fig. 5
	Round handle	
	Sharp	



Buck
16.5 cm / 6 1/2"

	J-31-831	Fig. 000
	J-31-841	Fig. 00
	J-31-851	Fig. 0
	J-31-861	Fig. 1
	J-31-871	Fig. 2
	J-31-881	Fig. 3
	J-31-891	Fig. 4
	J-31-901	Fig. 5
	Octagonal handle	
	Blunt	
	J-31-911	Fig. 000
	J-31-921	Fig. 00
	J-31-931	Fig. 0
	J-31-941	Fig. 1
	J-31-951	Fig. 2
	J-31-961	Fig. 3
	J-31-971	Fig. 4
	J-31-981	Fig. 5
	Octagonal handle	
	Sharp	



Myles
17 cm / 6 3/4"

	J-32-1620
	J-32-1630
	J-32-1640
	J-32-1650
	J-32-1660

Otology

Ear Polypus Snare and Foreign Body Forceps

Polypenzangen, Fremdkörperheber

Pinzas para polipos, Elevadores para cuerpos extraños



Littauer
J-31-1120
12 cm / 4 1/4"

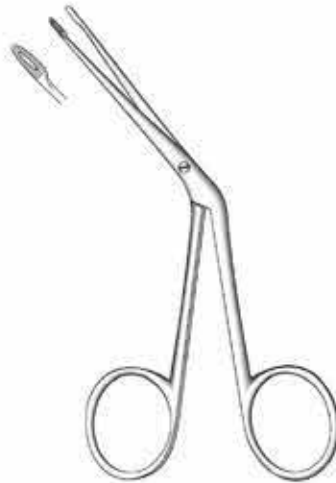

Hartmann
J-31-1130
12 cm / 4 3/4"
Fine model



Hartmann
J-31-1140
14 cm / 5 1/2"
Regular model



Tilley
J-31-1150
18.5 cm / 6 3/4"



Quire
J-31-1160
10.5 cm / 4"
Foreign body lever

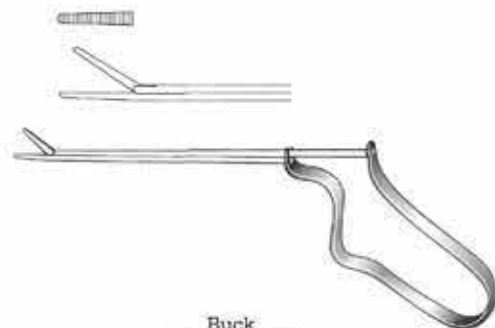

Buck
J-31-1170
11.5 cm / 4 1/2"
Foreign body forceps



Hartmann
J-31-1180 8.5 cm / 3 1/8"
J-31-1182 12 cm / 4 3/4"
J-31-1190 14 cm / 5 1/2"
J-31-1200 16.5 cm / 6 1/2"



Hartmann Wullstein
J-31-1210
 8.5 cm / 3 3/8"



Hartmann Wullstein
J-31-1220
 8.5 cm / 3 3/8"



Hartmann
J-31-1230 8.5 cm / 3 3/8"
J-31-1232 12 cm / 4 3/4"
J-31-1240 14 cm / 5 1/2"
 1.2 Teeth



Hartmann Noyes
J-31-1250
 9 cm / 3 5/8"



Hartmann Noyes
J-31-1260
 9 cm / 3 5/8"
 1.2 Teeth



Hartmann Weingartner
J-31-1270
 8.5 cm / 3 3/8"



Hartmann
J-31-1280
 8.5 cm / 3 3/8"



Hartmann
J-31-1290 8.5 cm / 3 3/8"
J-31-1291 12 cm / 4 3/4"
J-31-1292 14 cm / 5 1/2"
 2 mm \varnothing
J-31-1300 8.5 cm / 3 3/8"
J-31-1301 12 cm / 4 3/4"
J-31-1302 14 cm / 5 1/2"
 2.5 mm \varnothing
J-31-1310 8.5 cm / 3 3/8"
J-31-1311 12 cm / 4 3/4"
J-31-1312 14 cm / 5 1/2"
 3 mm \varnothing



Hartmann
J-31-1320
 8.5 cm / 3 3/8"



Struempel
J-31-1330
 8.5 cm / 3 3/8"



Hartmann
J-31-1340
 8.5 cm / 3 3/8"



Hartmann
J-31-1350
 8.5 cm / 3 3/8"

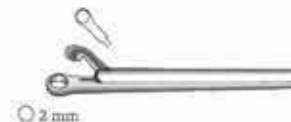

Hartmann Hoffmann
J-31-1360
 8.5 cm / 3 3/8"

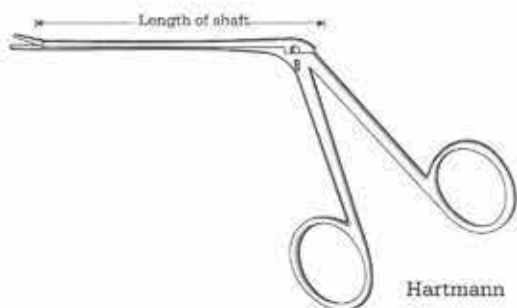

J-31-3000
 80 mm
J-31-3001
 110 mm
 Smooth, Straight

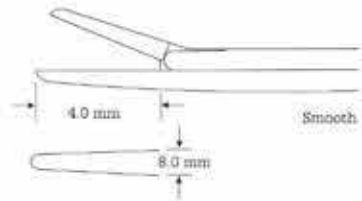

J-31-3050
 80 mm
J-31-3051
 110 mm
 Serrated, Straight

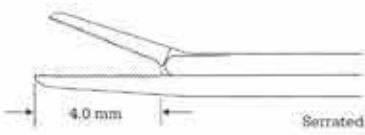

J-31-3055
 80 mm
J-31-3056
 110 mm
 Upward, Serrated



J-31-3060
 80 mm
J-31-3061
 110 mm
 Right, Serrated

J-31-3065
 80 mm
J-31-3066
 110 mm
 Left, Serrated

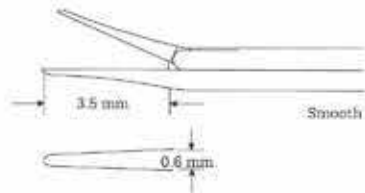

J-31-3080
 80 mm
J-31-3081
 110 mm
 Smooth, straight

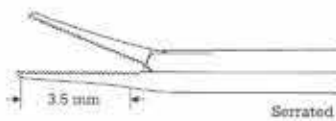

J-31-3090
 80 mm
J-31-3091
 110 mm
 Serrated, straight

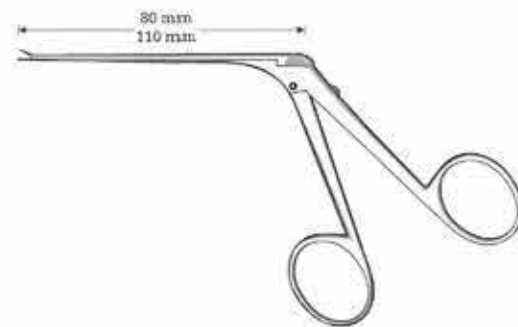

McGee-Mini

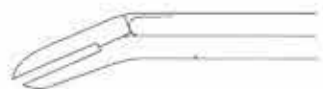

- J-31-3100**
- J-31-3105** Black finish
80 mm
- J-31-3101**
- J-31-3106** Black finish
110 mm
0.8 x 3.5 mm
- J-31-3110**
- J-31-3115** Black finish
80 mm
- J-31-3111**
- J-31-3116** Black finish
110 mm
0.8 x 6 mm

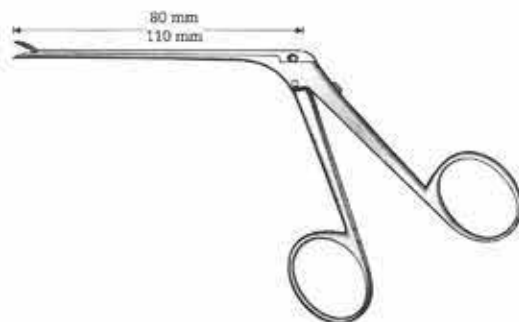

McGee
Wire bending forceps
bends downward



- J-31-3120**
- J-31-3125** Black finish
80 mm
- J-31-3121**
- J-31-3126** Black finish
110 mm
Upward cutting
- J-31-3130**
- J-31-3135** Black finish
80 mm
- J-31-3131**
- J-31-3136** Black finish
110 mm
Downward cutting

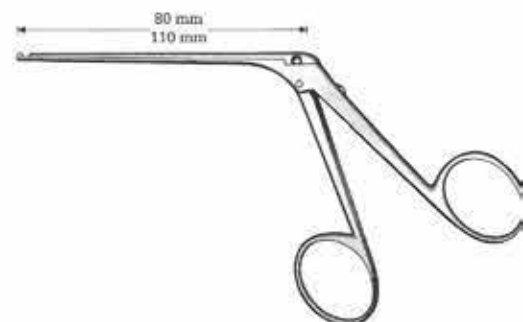

House-Dieter
Malleus nipper



- J-31-3150**
- J-31-3155** black finish
80 mm
- J-31-3151**
- J-31-3156** black finish
110 mm
Right cutting
- J-31-3160**
- J-31-3165** black finish
80 mm
- J-31-3161**
- J-31-3166** black finish
110 mm
Left cutting

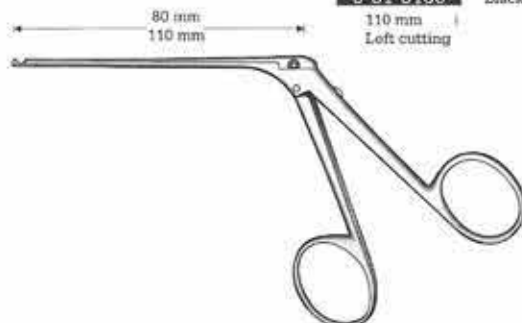

House-Dieter
Malleus nipper



- J-31-3180**
- J-31-3185** Black finish
80 mm
- J-31-3181**
- J-31-3186** Black finish
110 mm
For teflon prosthesis

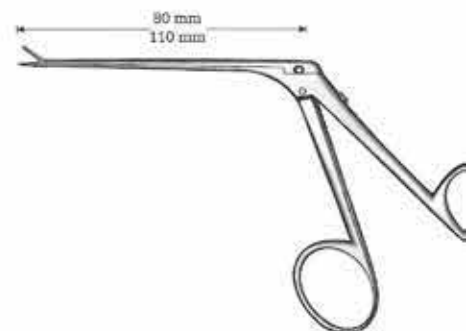

Fuller
Introducing forceps

Otology

Micro Cup-Shaped-Forceps and Micro Ear Forceps

Mikro Löffelzangchen und Mikro-Ohrzangchen

Micro-Pinzas con boca en forma de Cucharilla y Micro-pinza auriculares

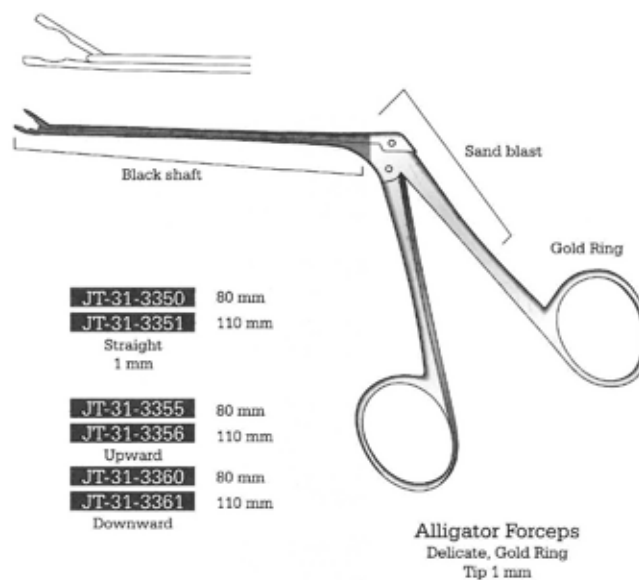
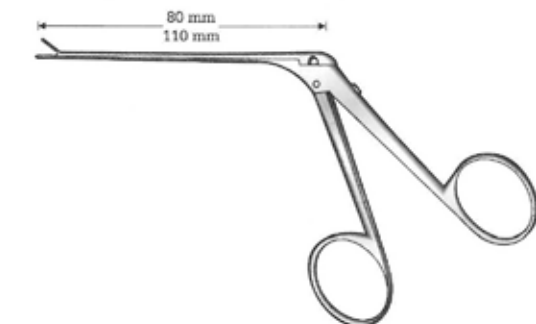
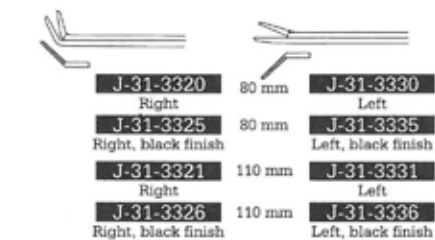
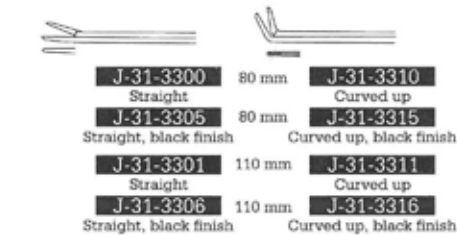
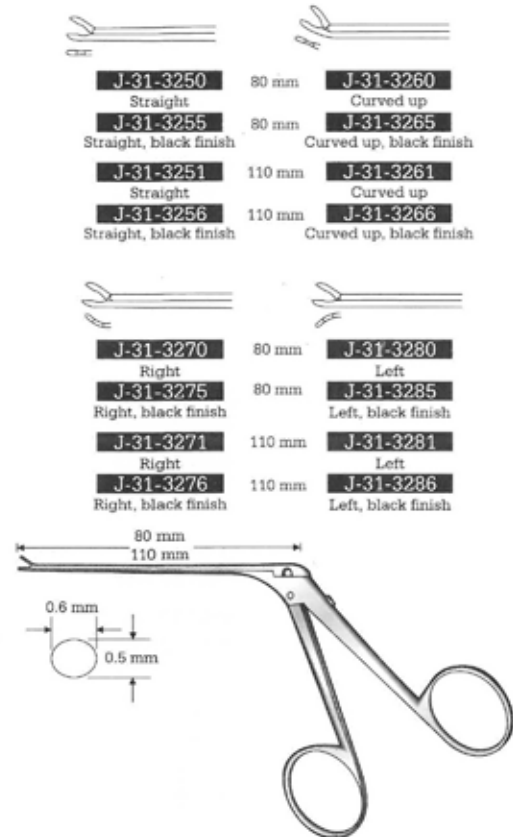
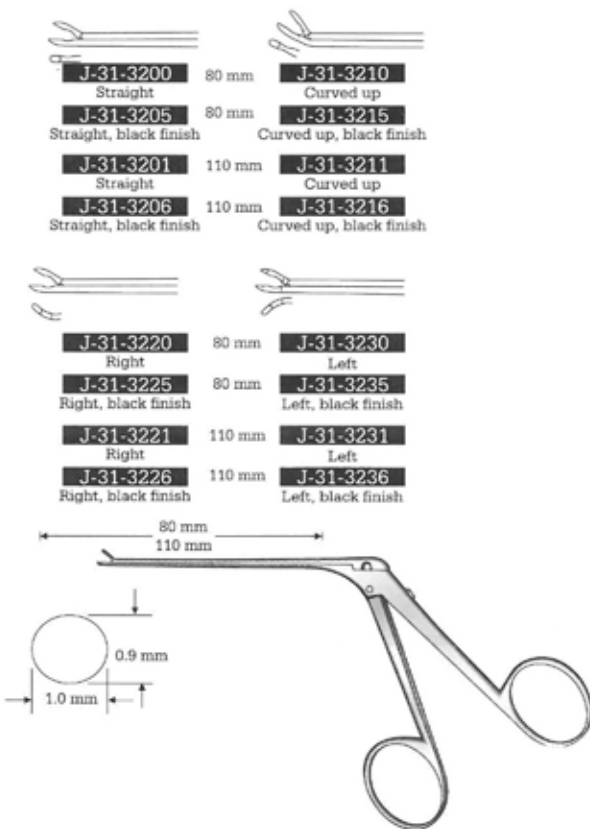

J-31-3370 Straight
J-31-3375 Straight, black finish
 80 mm
J-31-3371 Straight
J-31-3376 Straight, black finish
 110 mm
 4.0 x 0.6 mm

J-31-3400 Straight
J-31-3405 Straight, black finish
 80 mm
J-31-3401 Straight
J-31-3406 Straight, black finish
 110 mm



J-31-3410 Curved up
J-31-3415 Curved up, black finish
 80 mm
J-31-3411 Curved up
J-31-3416 Curved up, black finish
 110 mm

J-31-3420 Right
J-31-3425 Right, black finish
 80 mm
J-31-3421 Right
J-31-3426 Right, black finish
 110 mm



J-31-3430 Left
J-31-3435 Left, black finish
 80 mm
J-31-3431 Left
J-31-3436 Left, black finish
 110 mm

J-31-3450 Straight
J-31-3455 Straight, black finish
 80 mm
J-31-3451 Straight
J-31-3456 Straight, black finish
 110 mm

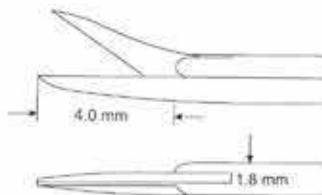

J-31-3460 Curved up
J-31-3465 Curved up, black finish
 80 mm
J-31-3461 Curved up
J-31-3466 Curved up, black finish
 110 mm

J-31-3470 Right
J-31-3475 Right, black finish
 80 mm
J-31-3471 Right
J-31-3476 Right, black finish
 110 mm

J-31-3480 Left
J-31-3485 Left, black finish
 80 mm
J-31-3481 Left
J-31-3486 Left, black finish
 110 mm

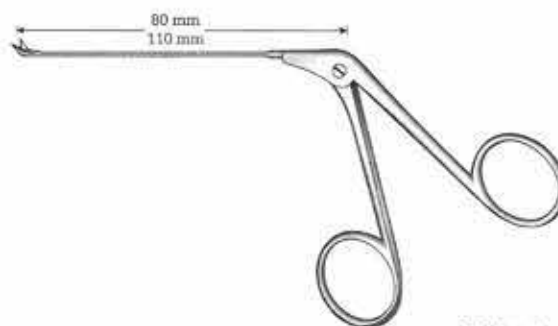
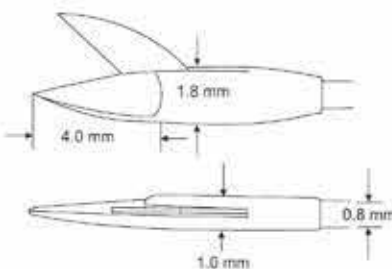

Bellucci
Very delicate



Wullstein

Otology

Wire Closure Forceps, Mastoid Rongeurs

Drahtbiegezaugchen, Ohr-Knochenstanzen

Pinzas para doblar alambre, Pinzas cortantes para huesos

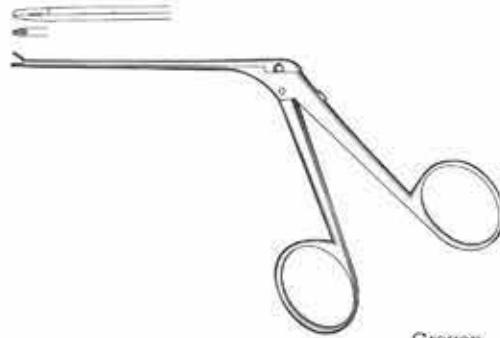

Greven
J-31-1385

2 mm 

3 mm 



Citelli
J-31-1386 2 mm
J-31-1387 3 mm

2 mm 



Beyer
J-31-1388

1 mm 



Beyer
J-31-1389



Goldsmith Thudichum

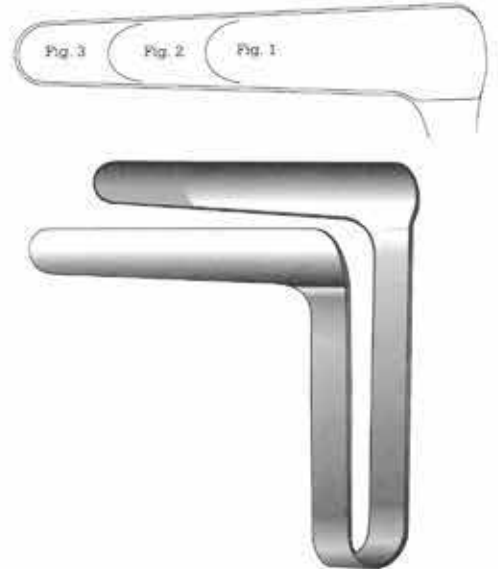
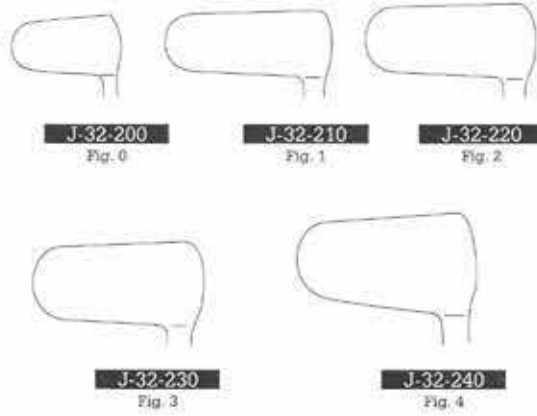

St. Clair Thomson

- J-32-250** Fig. 1, 35 mm
- J-32-260** Fig. 2, 50 mm
- J-32-270** Fig. 3, 75 mm



Voltolini

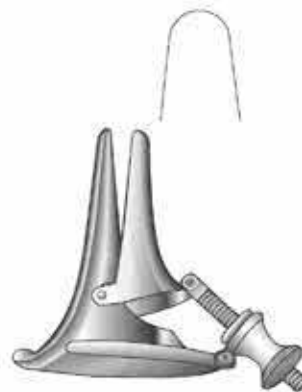

Vacher

J-32-190



Yankauer

J-32-280
 19 cm / 7 1/2"



Hartmann
18.5 cm / 6 7/8"

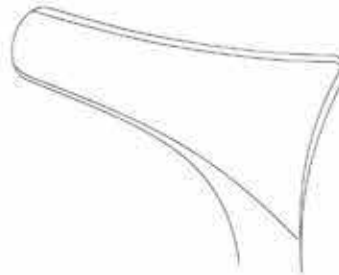

J-32-001
Fig. 1

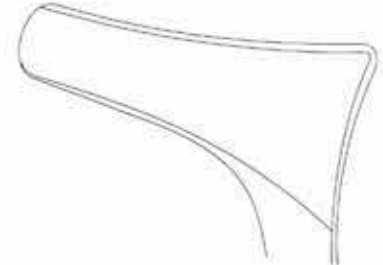

J-32-010
Fig. 2

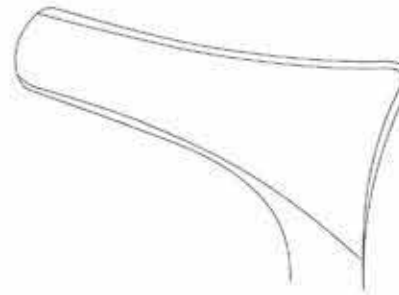

J-32-020
Fig. 3



Hartmann-Halle
15 cm / 6"



J-32-030
Fig. 1

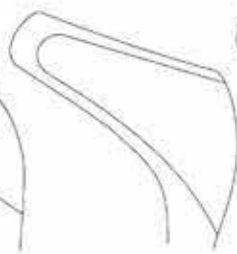

J-32-040
Fig. 2

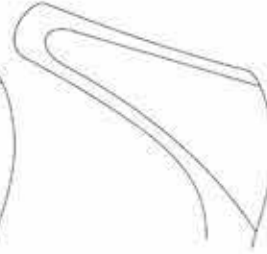

J-32-050
Fig. 3



Mod. Surgeon
J-32-051
13 cm / 5 1/8"



Mod. Surgeon
J-32-052
 13 cm / 5"

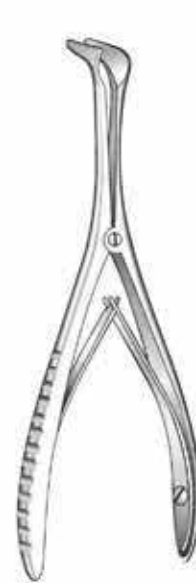

Tieck-Halle
 13.5 cm / 5 1/4"

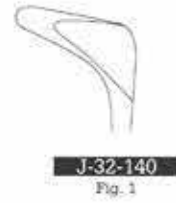

J-32-140
 Fig. 1



J-32-141
 Fig. 2

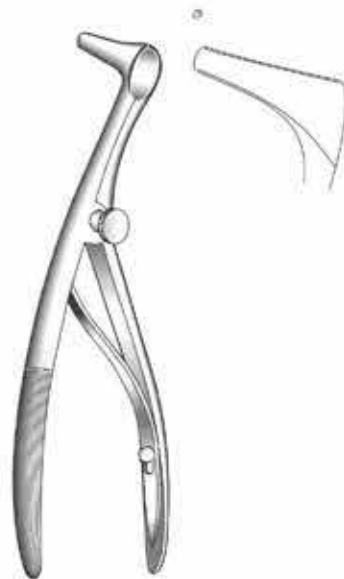

Beckman
J-32-053
 15 cm / 6"



Vienna
J-32-100 Infant
J-32-110 Child
J-32-120 Adult
J-32-125 Sheet
J-32-130 Metal
 14.5 cm / 5 3/4"



Killian
 13 cm / 5"

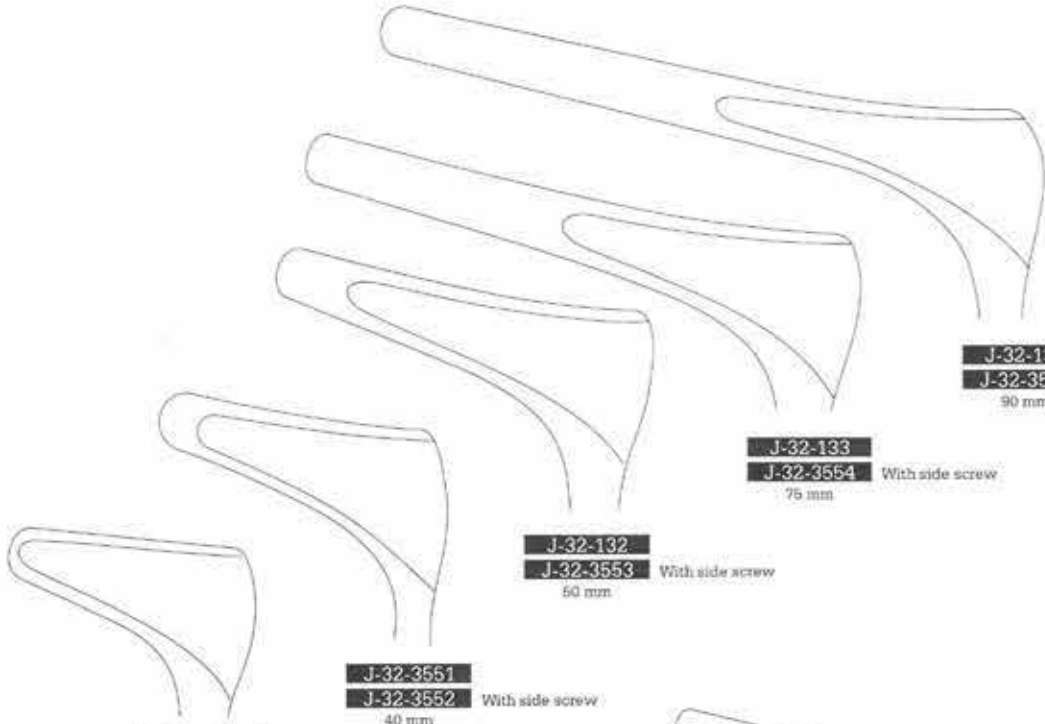

J-32-134
J-32-3555 With side screw
 90 mm

J-32-133
J-32-3554 With side screw
 75 mm

J-32-132
J-32-3553 With side screw
 50 mm

J-32-3551
J-32-3552 With side screw
 40 mm

J-32-131
J-32-3550 With side screw
 35 mm

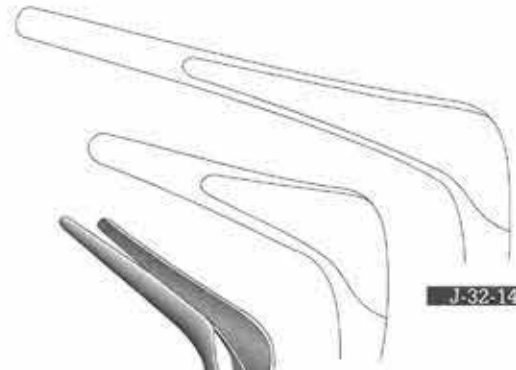

J-32-142

J-32-143



Cottle
 14 cm / 5 1/2"
 Extra thin blades

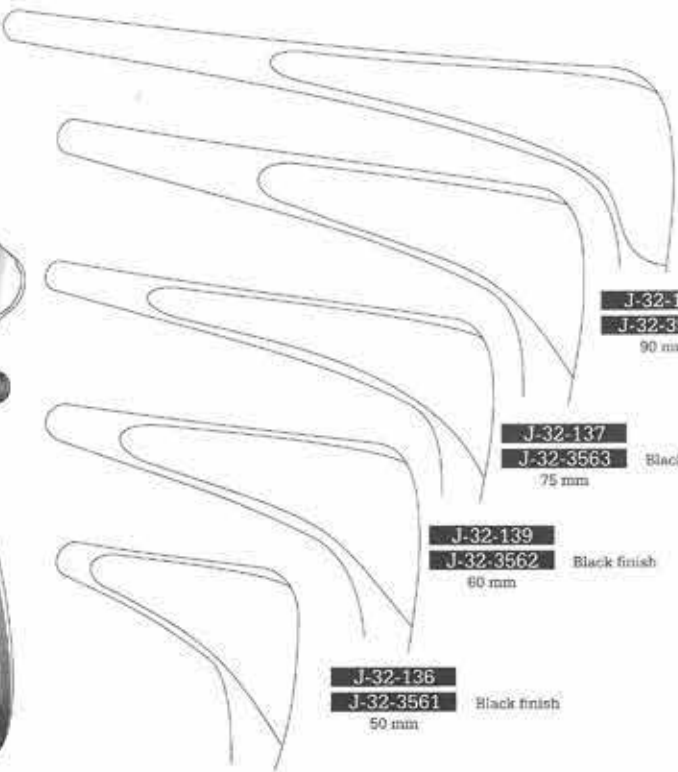

J-32-138
J-32-3564 Black finish
 90 mm

J-32-137
J-32-3563 Black finish
 75 mm

J-32-139
J-32-3562 Black finish
 60 mm

J-32-136
J-32-3561 Black finish
 50 mm

J-32-135
J-32-3560 Black finish
 35 mm



Dull black chrome plated



J-32-144
 70 x 8.5 mm blade
 For adults

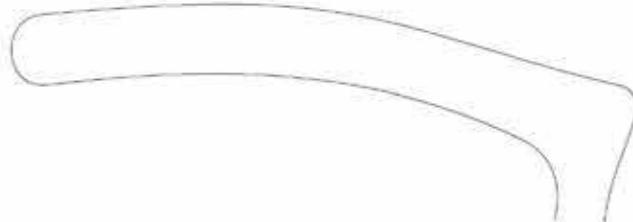

J-32-145
 80 x 8.5 mm blade
 For adults



J-32-146
 60 x 7.0 mm blade
 For children



J-32-147
 70 x 7.0 mm blade
 For children



Tessier
 17 cm / 6 3/4"
 For dilation, black chromium plated

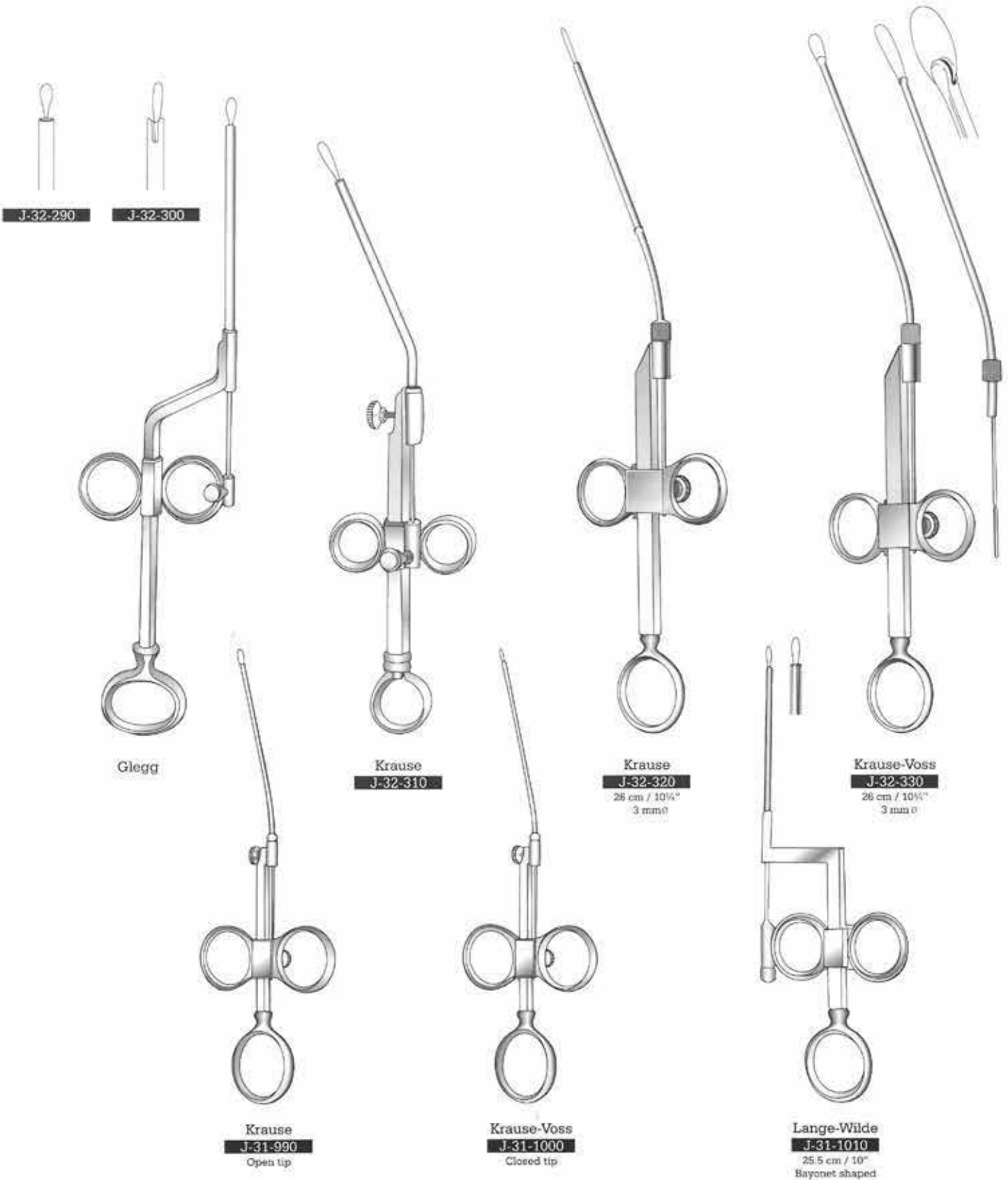

Glegg

Krause
J-32-310

Krause
J-32-320
 26 cm / 10 1/4"
 3 mm Ø

Krause-Voss
J-32-330
 26 cm / 10 1/4"
 3 mm Ø

Krause
J-31-990
 Open tip

Krause-Voss
J-31-1000
 Closed tip

Lange-Wilde
J-31-1010
 25.5 cm / 10"
 Bayonet shaped



Troeltsch (wilde)
J-31-1060
 11 cm / 4 1/4"

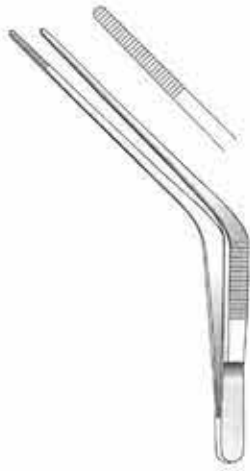

Troeltsch (wilde)
J-31-1070
 12 cm / 4 3/4"



Troeltsch (wilde)
J-31-1080
 13 cm / 5"



Lucae
J-31-1090
J-31-3570 1:2 Teeth
 14 cm / 5 1/2"



Jansen
J-31-1100 16 cm / 6 1/4"
J-31-1110 20 cm / 8"



J-31-1020 0.3 mm Ø
J-31-1030 0.4 mm Ø
 Snare wire



J-31-1040 0.2 mm Ø
J-31-1050 0.3 mm Ø
 10.5 cm / 4"
 Snare wire
 12 pieces



Troeltsch
J-32-371
 15 cm / 6"

Troeltsch
J-32-372
 18 cm / 7"



Gruenwald (Jansen)
J-32-3580
 16 cm / 6 1/4"
J-32-373
 20 cm / 8"

Rhinology

Nasal Polypus and Septum Compression 'Forceps

Polypanzangen, Septumzange

Pinzas para Polipos, Pinza para el tabique nasal

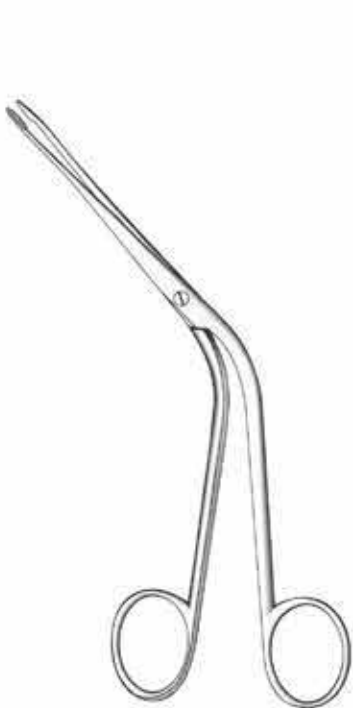

Hartmann
J-32-374
16 cm / 6 1/4"

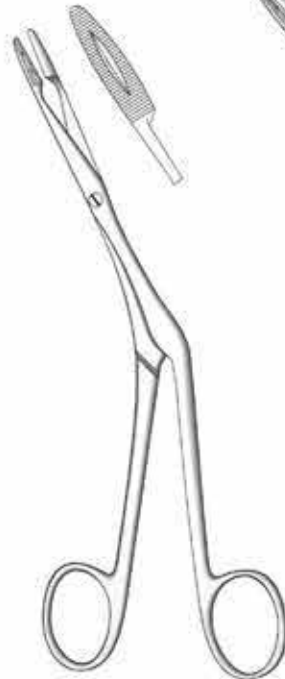

Heymann-Knight
J-32-375
18 cm / 7"

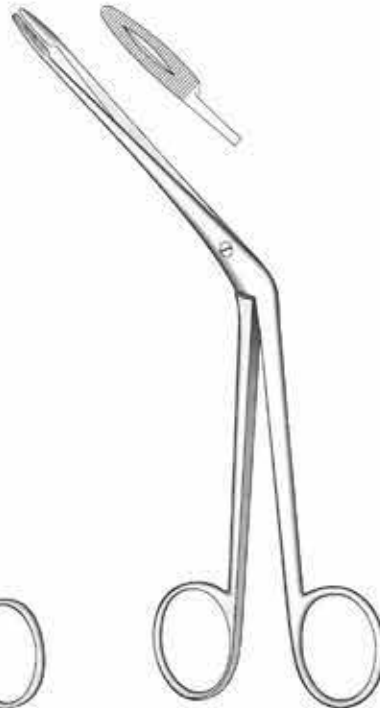

Hartmann
J-32-376
20 cm / 8"

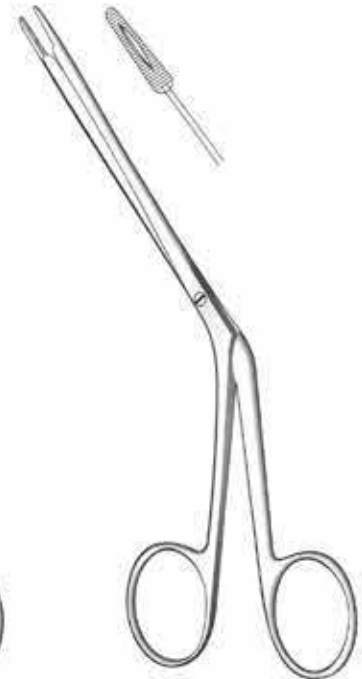

Littauer
J-32-377
18 cm / 7"

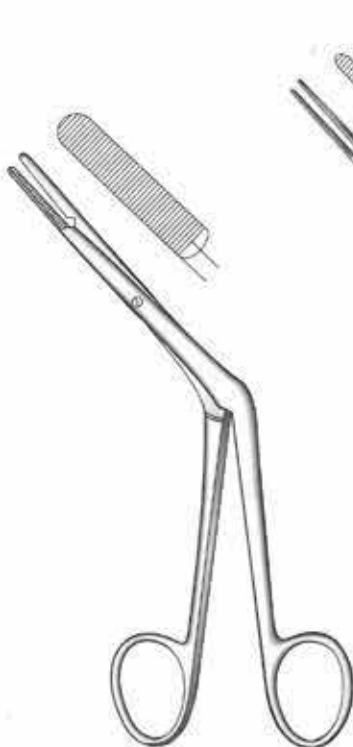

Killian
J-32-378
17 cm / 6 3/4"



Westmacott
J-32-379
20 cm / 8"

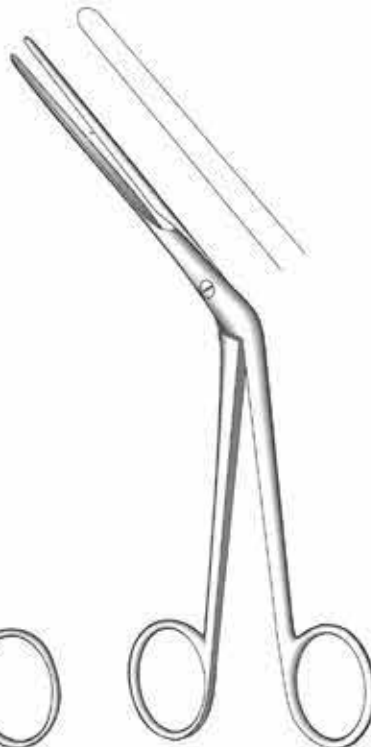

Lubet-Barbon
J-32-382
20 cm / 8"
Nasal tampon forceps

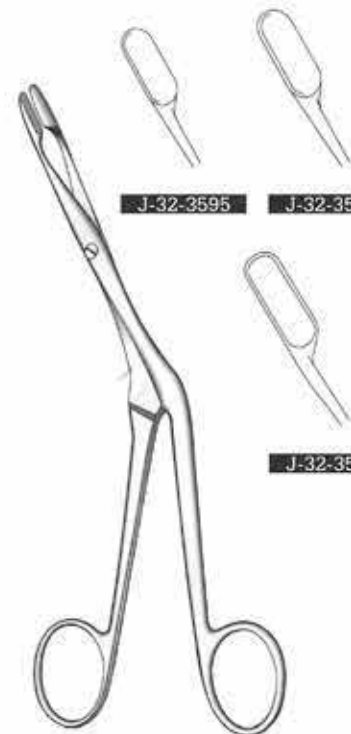

Heymann
18 cm / 7"

J-32-3595

J-32-3597

J-32-3599

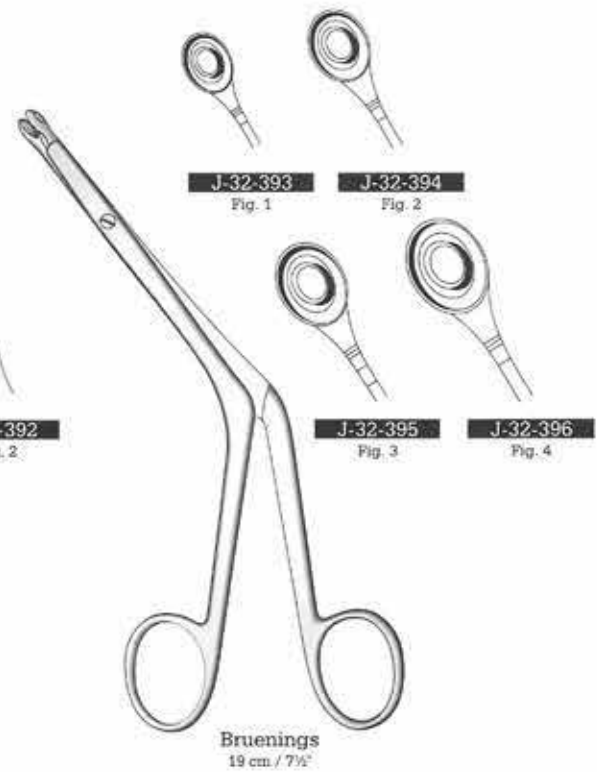
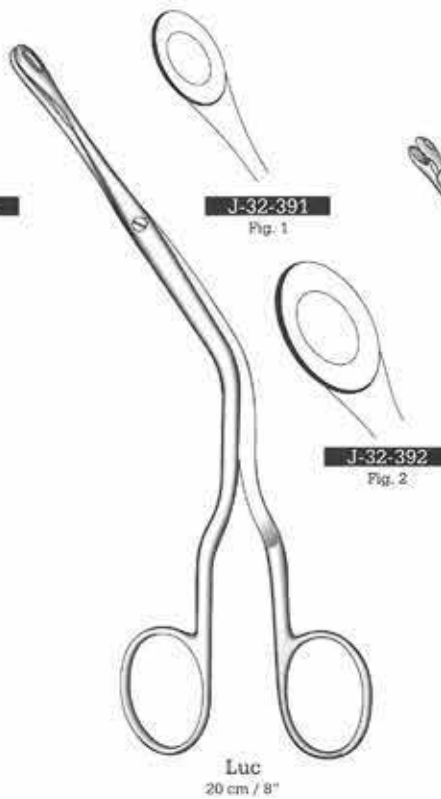
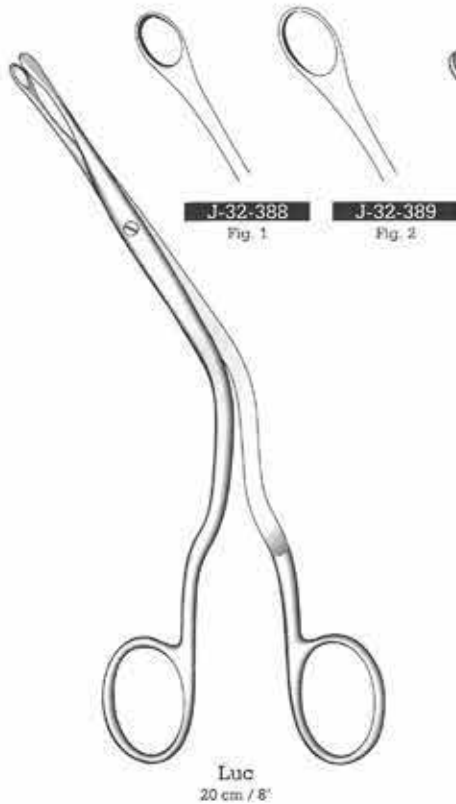
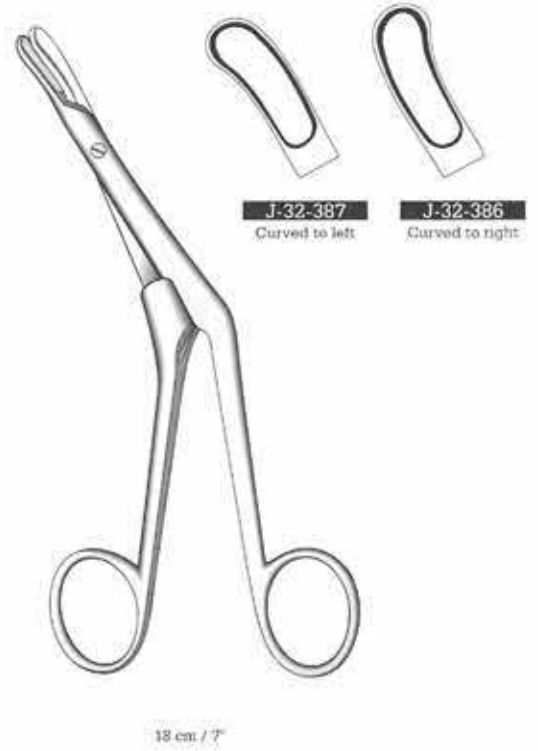
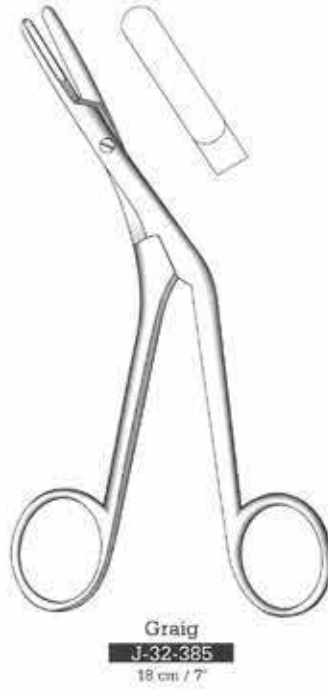
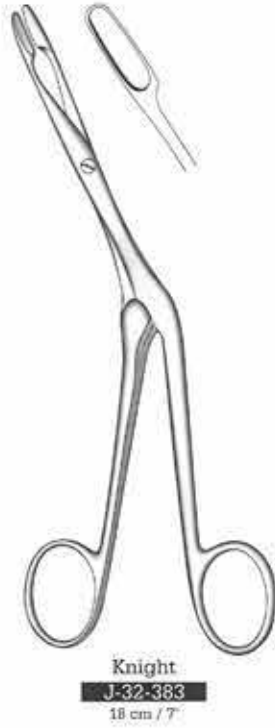

Rhinology

Ethmoid Bone Forceps, Nasal Cutting Forceps

Siebbeinzangen, Scharfe Nasenzangen

Pinzas para etmoides, Pinzas nasal Cortantes

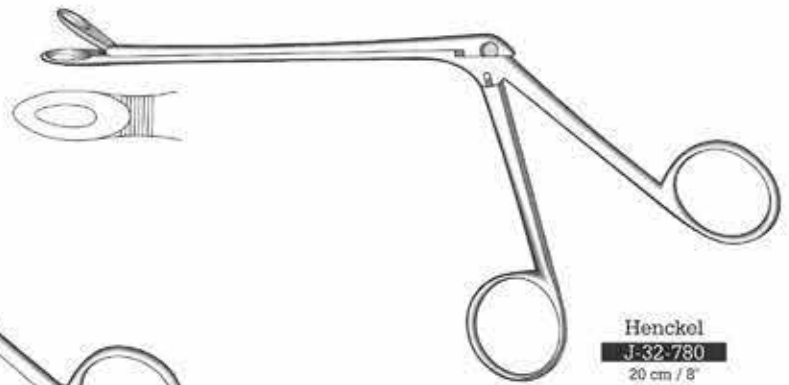
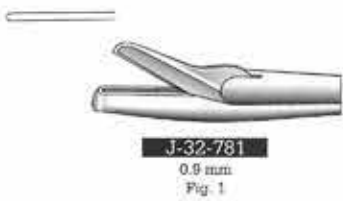
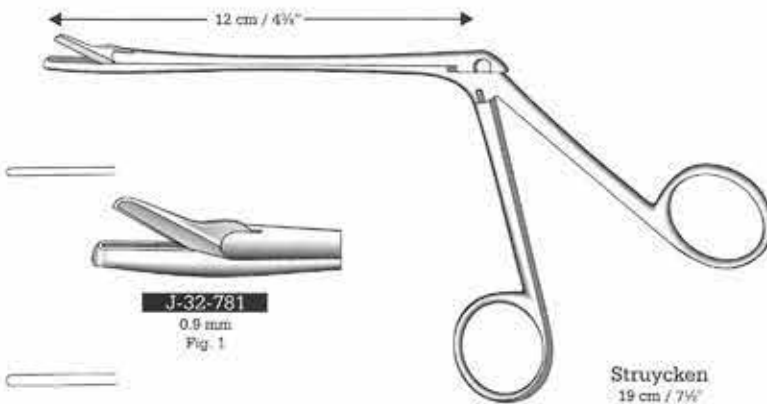
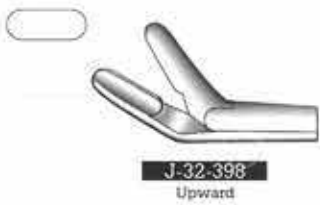
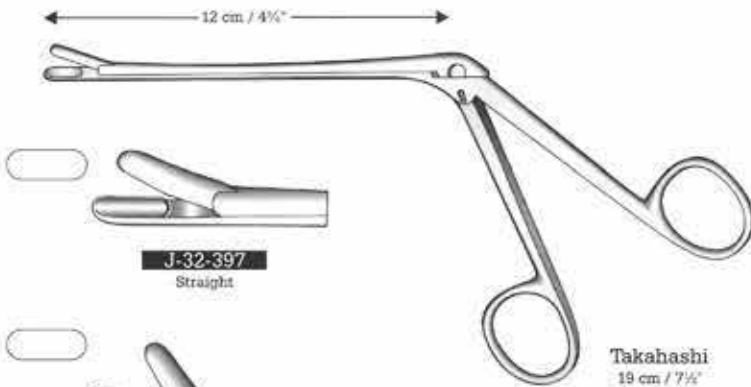
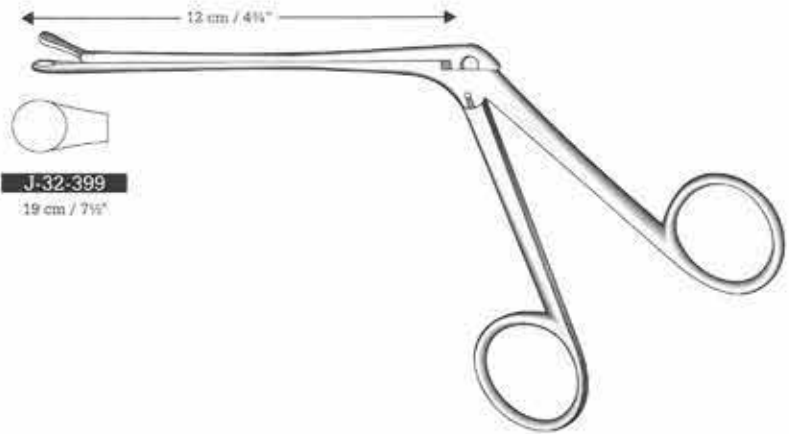
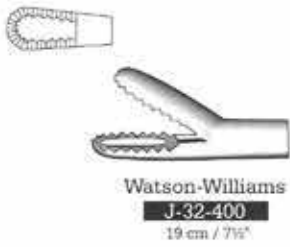

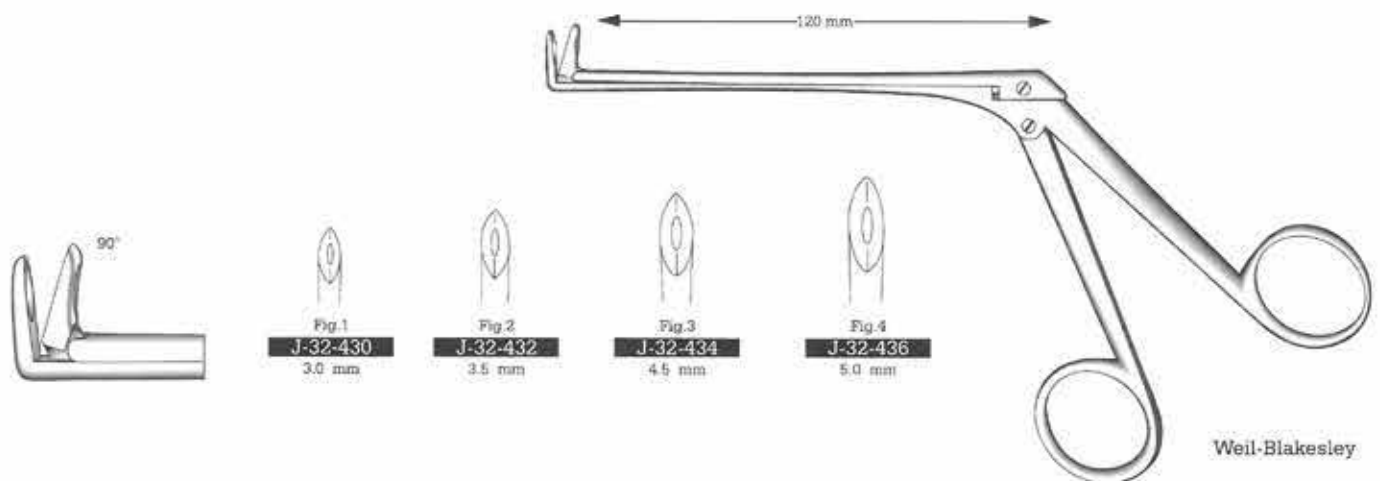
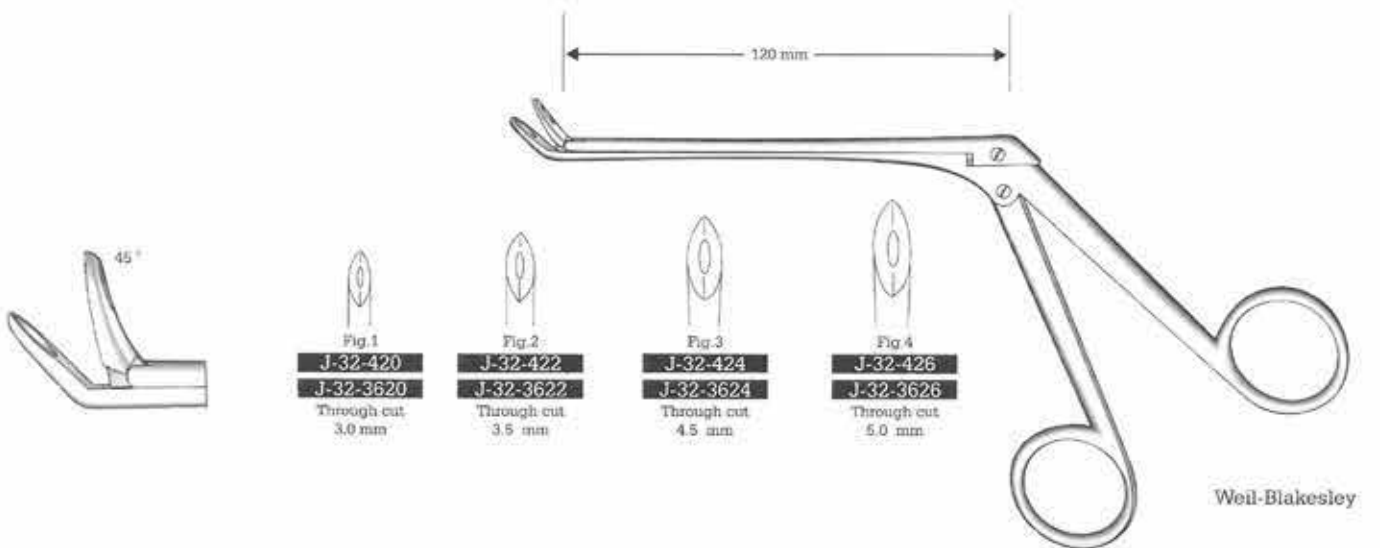
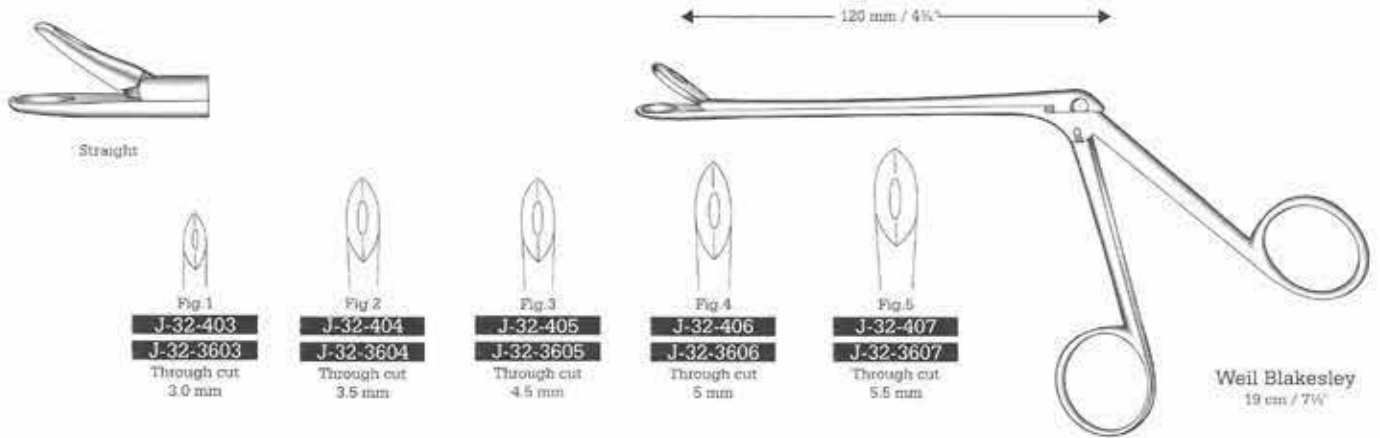



19 cm / 7 1/2"



Myles
19 cm / 7 1/2"
Shaft 12 cm



Hartmann
19 cm / 7 1/2"
Shaft 12 cm

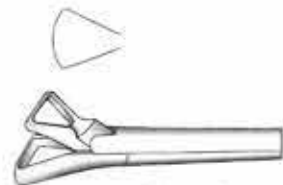

Schmeden
J-32-879
19 cm / 7 1/2"
Shaft 12 cm

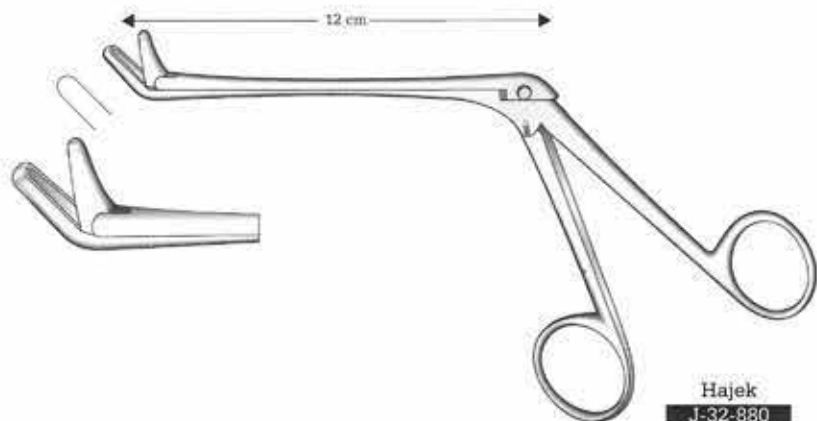

Hajek
J-32-880
19 cm / 7 1/2"



J-32-925
2 mm
Up cutting



J-32-926
2 mm
Right cutting



J-32-927
2 mm
Left cutting

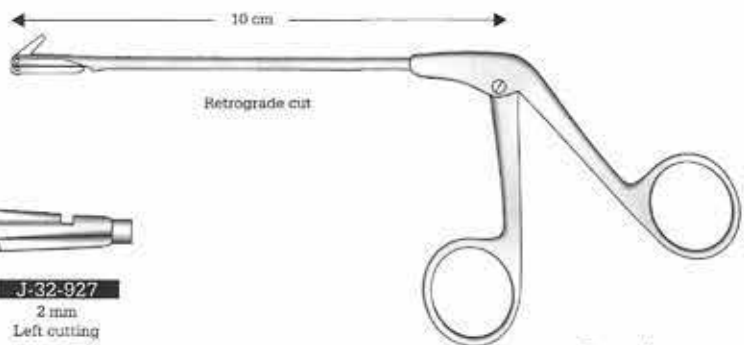

Stammberger
Antrum punch

Instruments with Tungsten Carbide Inserts
TC GOLD

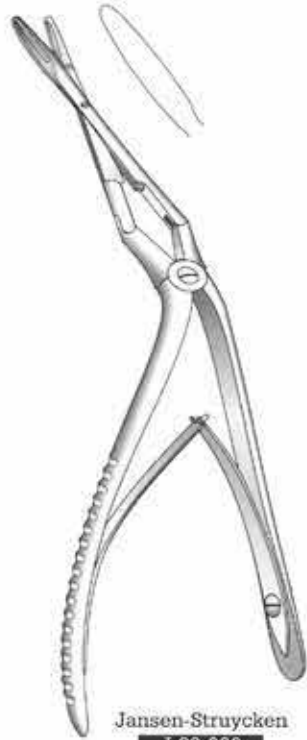

Jansen-Struycken
J-32-930
 19 cm / 7½"

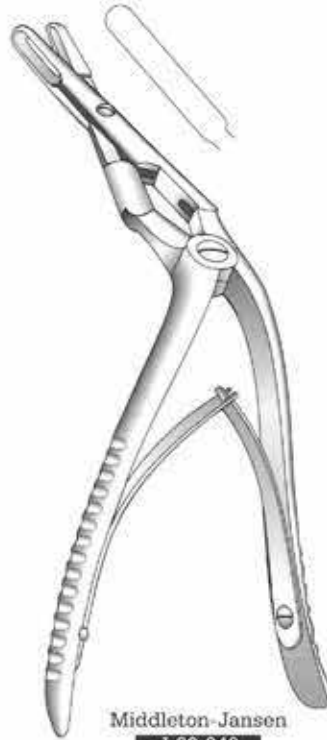

Middleton-Janson
J-32-940
 19 cm / 7½"

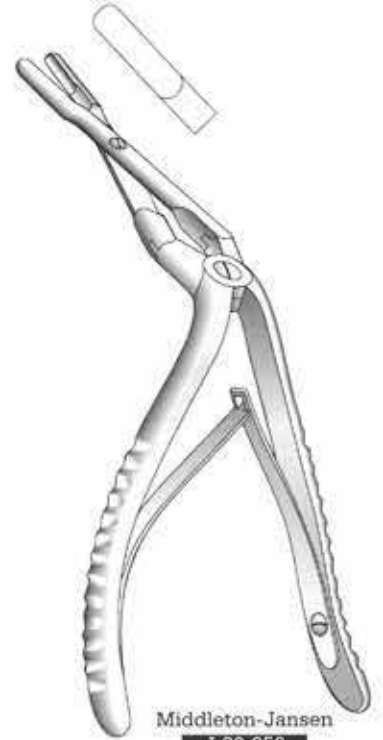

Middleton-Janson
J-32-950
 19 cm / 7½"

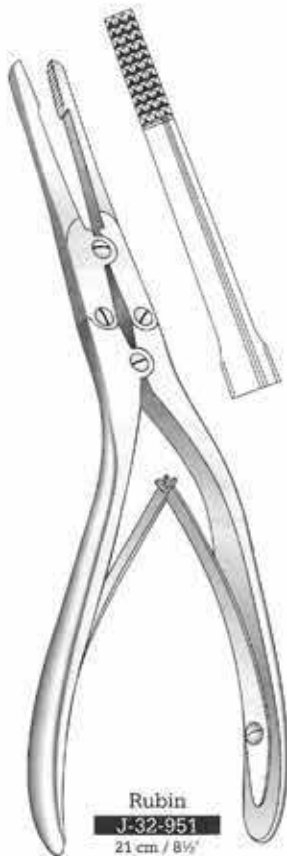

Rubin
J-32-951
 21 cm / 8½"

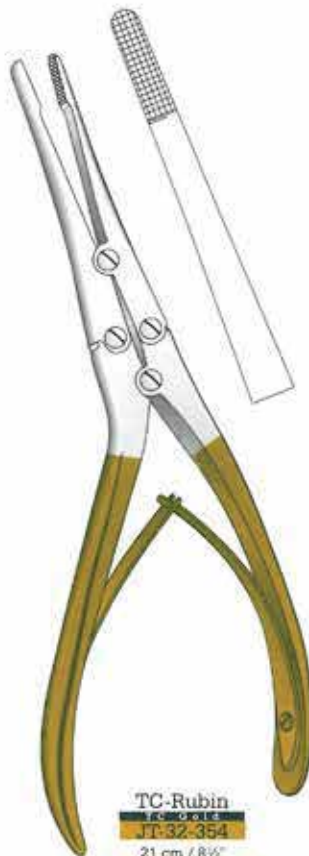

TC-Rubin
J-32-354
 21 cm / 8½"
 Surgi Grip



Caplan
J-32-953
 20 cm / 8"

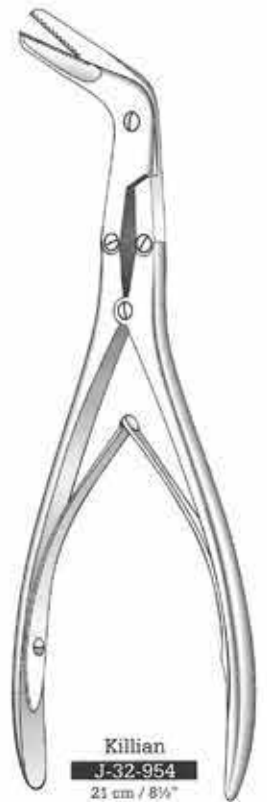

Killian
J-32-954
 21 cm / 8½"

Otology

Bone Contouring Forceps

Knochenformzangen

Pinzas para format huesos



Marchac
J-32-3300
18 cm / 7"
6.5 mm
Convex / Concave
For children

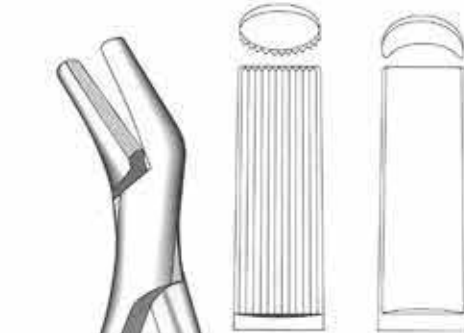

Marchac
J-32-3310
18 cm / 7"
11 mm
Convex / Concave
For children

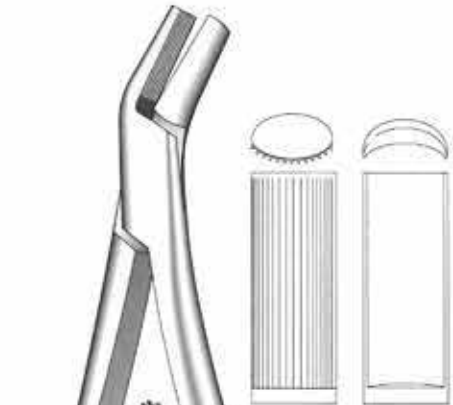

Tessier
J-32-3320
22 cm / 8 1/2"
11 mm
Convex / Concave
Bone contouring forceps

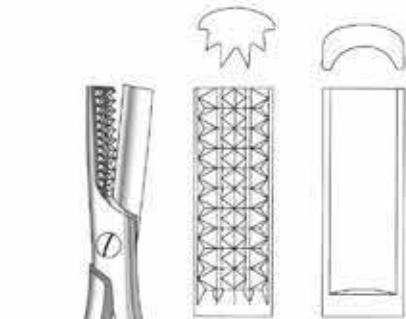

Obwegeser
J-32-3305
17 cm / 6 1/2"
12 x 30 mm
Convex / Concave
Jaw

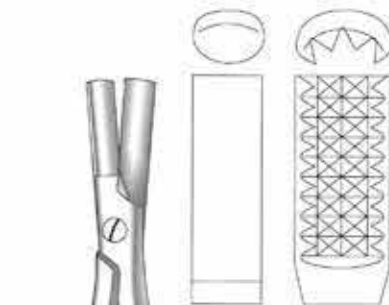

Obwegeser
J-32-3315
17.5 cm / 7"
13.5 x 30 mm
Concave / Convex
Tarsus

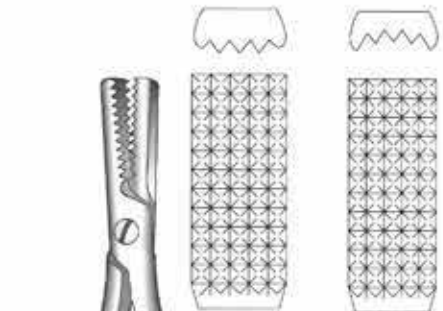

Obwegeser
J-32-3325
17.5 cm / 7"
13.5 x 30 mm
Flat / Flat
Tarsus

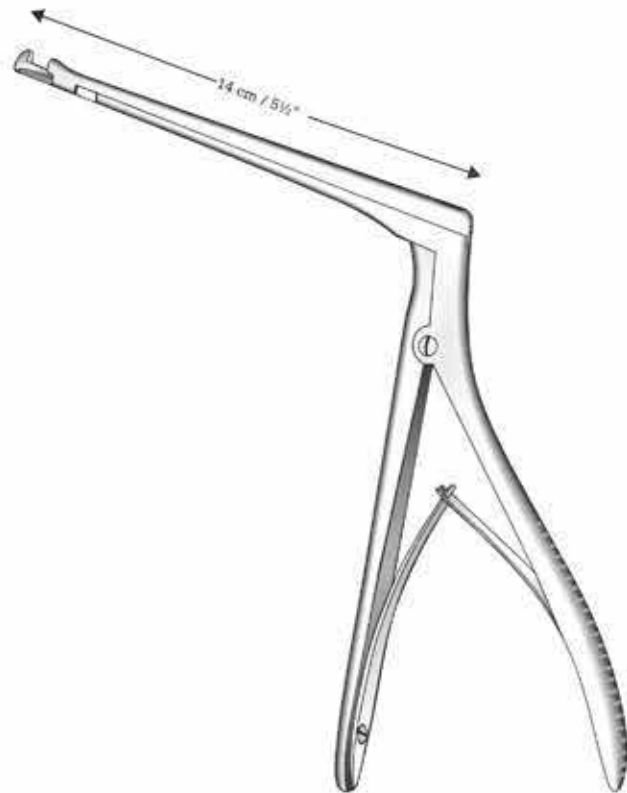
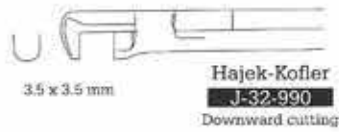
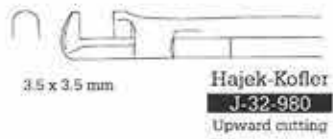
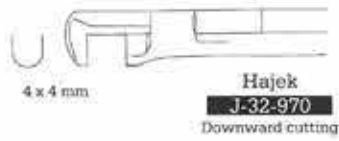
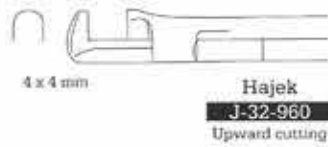

Rhinology

Rongeur Forceps and Antrum Punches Forceps
 MeiBelzangen, Kieferhohlenstanzen
 Pinzas gubias, Pinzas Sacabocadas para seno maxilar



- J-32-1081** 2 x 10 mm
- J-32-1082** 3 x 10 mm
- J-32-1083** 4 x 10 mm
- J-32-1084** 5 x 10 mm
- J-32-3630** 6 x 10 mm
Curved up



- J-32-1085** 2 x 10 mm
- J-32-1086** 3 x 10 mm
- J-32-1087** 4 x 10 mm
- J-32-3635** 5 x 10 mm
- J-32-3640** 6 x 10 mm
Straight



- J-32-1088** 2 x 10 mm
- J-32-1089** 3 x 10 mm
- J-32-1091** 4 x 10 mm
- J-32-3650** 5 x 10 mm
- J-32-3655** 6 x 10 mm
Curved down

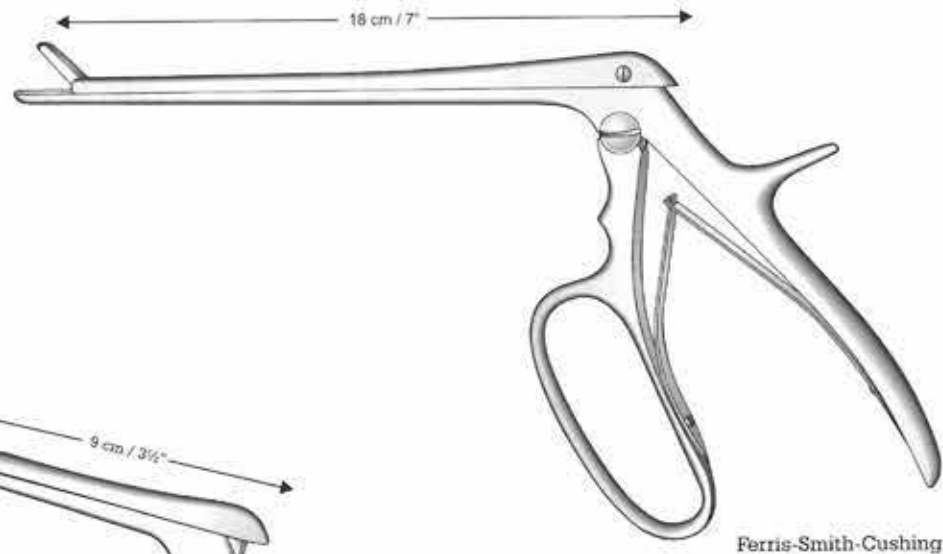

Ferris-Smith-Cushing



- 4 mm **J-32-1060**
4 x 4 mm
- 5 mm **J-32-1070**
5 x 5 mm
- 6 mm **J-32-1080**
6 x 6 mm



Kerrison
 20 cm / 8"
 Up cutting



Joseph
15 cm / 6"
Sharp



J-32-1090
Straight
Fig. 1



J-32-1100
Straight
Fig. 2



J-32-1110
Curved
Fig. 3



J-32-1120
Curved
Fig. 4



Joseph
15 cm / 6"
Blunt



J-32-1130
Straight
Fig. 1



J-32-1140
Straight
Fig. 2



J-32-1150
Curved
Fig. 3



J-32-1160
Curved
Fig. 4



Heymann
J-32-1170



Krieg
J-32-1180



Joseph
J-32-1190
15 cm / 6"
Straight



Cottle
J-32-1200



Ballenger
J-32-1210



Freer
J-32-1220



Freer
J-32-1230
Mucosa knife



Fomon
J-32-1231
18.5 cm / 6 3/4"



Converse
J-32-1232
15 cm / 6 1/4"
Curved blade 4 x 35 mm,
with button end bistouri



Cottle
J-32-1233
14 cm / 5 1/2"

Rhinology

Septum Knives/Septum Elevators and Raspatories

Septummesser/Septum-Elevatorian und Raspatorien

Bistouries para el tabique nasal Elevador para el tabique nasal Y Legras



Freer
J-32-1240



Freer
J-32-1250



Freer
J-32-1260
19 cm / 7½"



Freer
J-32-1270
19 cm / 7½"



Freer
J-32-1280
19 cm / 7½"
Sharp
5 mm



Freer
J-32-1290
19 cm / 7½"
Blunt
6 mm



Freer
J-32-1300 16 cm / 6¼"
J-32-1305 19 cm / 7½"
Sharp / Blunt
5 / 5 mm



Durham
J-32-1310



Howarth
J-32-1320



Hill
J-32-1330



Freer
J-32-3350 19.5 cm / 7¾"
J-32-3351 22 cm / 8¾"
Blunt / Sharp
Square handle

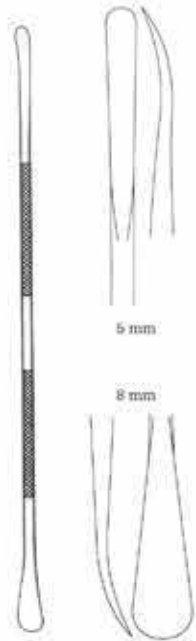

Terry
J-32-2100
 17 cm / 6 3/4"
 For elevation of alveolar flaps



Terry
J-32-2110
 11 cm / 4 1/4"
 Graft packer



J-32-2120
 13 cm / 5"
 Graft packer

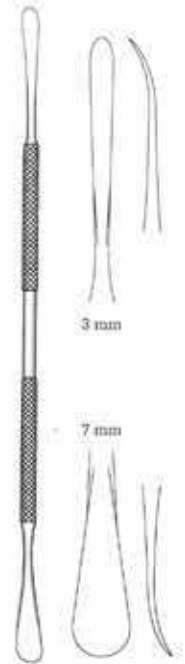

Terry
J-32-2130
 18 cm / 7"
 For subperiosteal tunnels



Obwegeser
J-32-2230
 20.5 cm / 8"



Obwegeser
J-32-2240
 20.5 cm / 8"



J-32-3360
 2 mm
 Sharp point

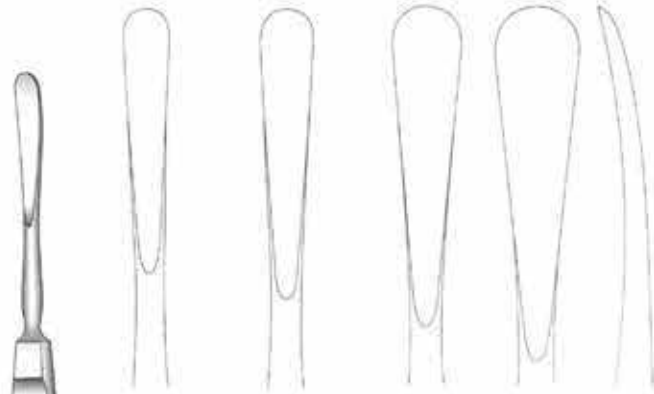

J-32-2320 6 mm **J-32-2321** 7 mm **J-32-2322** 8 mm **J-32-2323** 11 mm



Obwegeser
17.5 cm / 7"

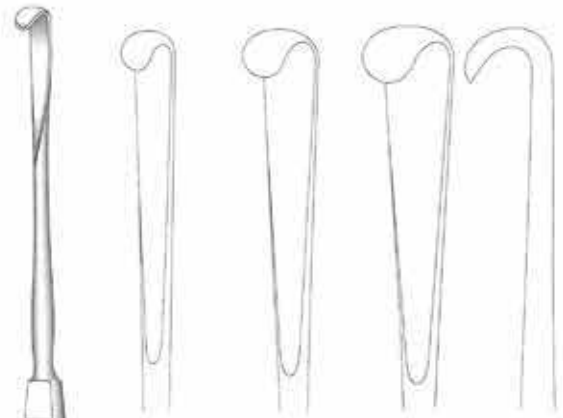

J-32-2330 5 mm **J-32-2331** 7 mm **J-32-2332** 8 mm



Obwegeser
20.5 cm / 8"

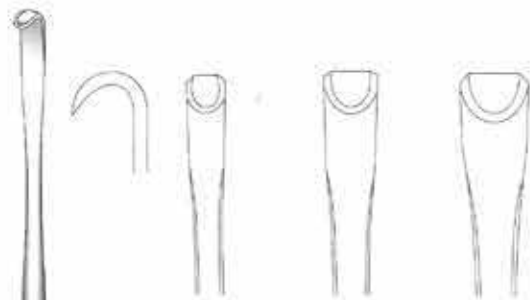

J-32-3365 5 mm **J-32-3370** 7 mm **J-32-3375** 9 mm



Obwegeser
20.5 cm / 8"

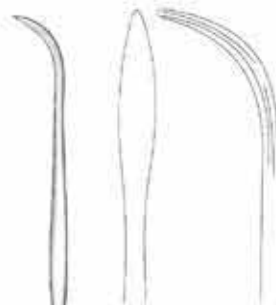

Steinhauser
J-32-2340
18.5 cm / 7 1/4"



Lane Periosteal Elevator
J-32-3390 Narrow tip sharp
J-32-3391 Wide tip sharp
J-32-3392 Narrow tip blunt
J-32-3393 Wide tip blunt
19 cm / 7 1/2"



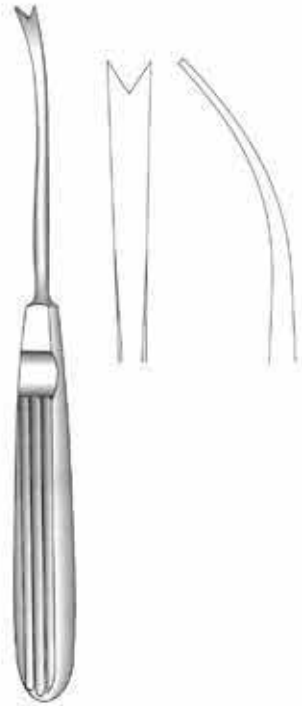

Steinhäuser
J-32-2280
 18 cm / 7"
 Reposition instrument



J-32-2270
 16 cm / 6 1/4"
 6 x 12 mm



J-32-2271
 16.5 cm / 6 1/2"
 6 x 19 mm



J-32-2272
 17 cm / 6 3/4"
 6 x 25 mm

Steinhäuser

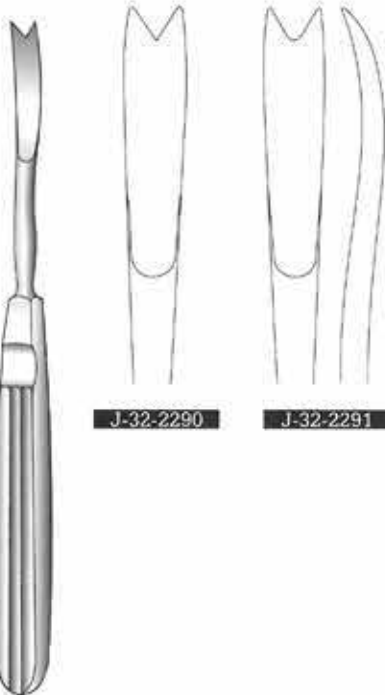

J-32-2290

J-32-2291

Obwegeser
 17.5 cm / 7"

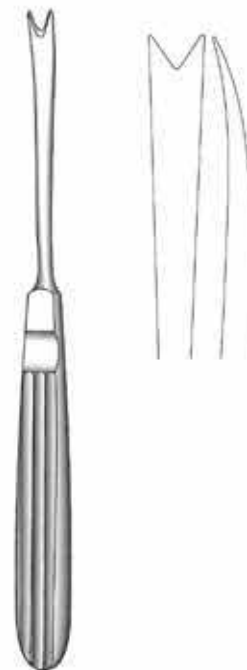

Obwegeser
J-32-2300
 17.5 cm / 7"
 7.5 mm

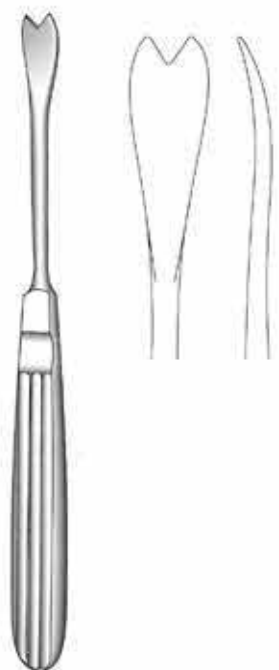

Obwegeser
J-32-2310
 17.5 cm / 7"
 11 mm

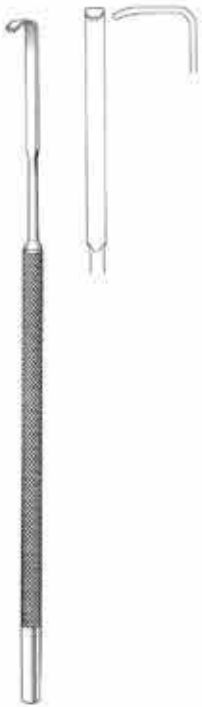

Salyer
J-32-2140
 18.5 cm / 7 1/4"
 Cleft palate hooklets
 Short blade



Salyer
J-32-2150
 18.5 cm / 7 1/4"
 Cleft palate hooklets
 Long blade



Salyer
J-32-2160
 18 cm / 7"
 Cleft palate dissector
 Nasal



Salyer
J-32-2170
 18 cm / 7"
 Cleft palate dissector
 Nasal



Salyer
J-32-2180
 18 cm / 7"
 Cleft palate instruments

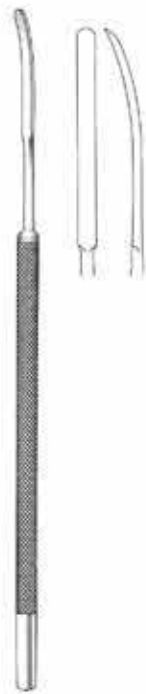

Salyer
J-32-2190
 18 cm / 7"
 Cleft palate elevator



Salyer
J-32-2200
 18 cm / 7"
 Cleft palate elevator



Jaboma
J-32-2210
 17 cm / 6 3/4"
 Cleft palate periosteal elevator



Obwegeser
 18 cm / 7"
 Angled cutting



J-32-2260
 6 mm



J-32-2261
 7 mm



J-32-2262
 9 mm



J-32-2263
 11 mm



Hargis
 23 cm / 9"



J-32-3510
 6.5 mm
 Right



J-32-3511
 9 mm
 Right



J-32-3512
 6.5 mm
 Left



J-32-3513
 9 mm
 Left



Marchac
15.5 cm / 6"



J-32-2350
7.5 mm

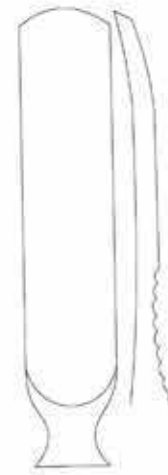

J-32-2351
12 mm



Marchac
17 cm / 6 3/4"



J-32-2360
2 mm



J-32-2361
3.5 mm



J-32-2362
5 mm

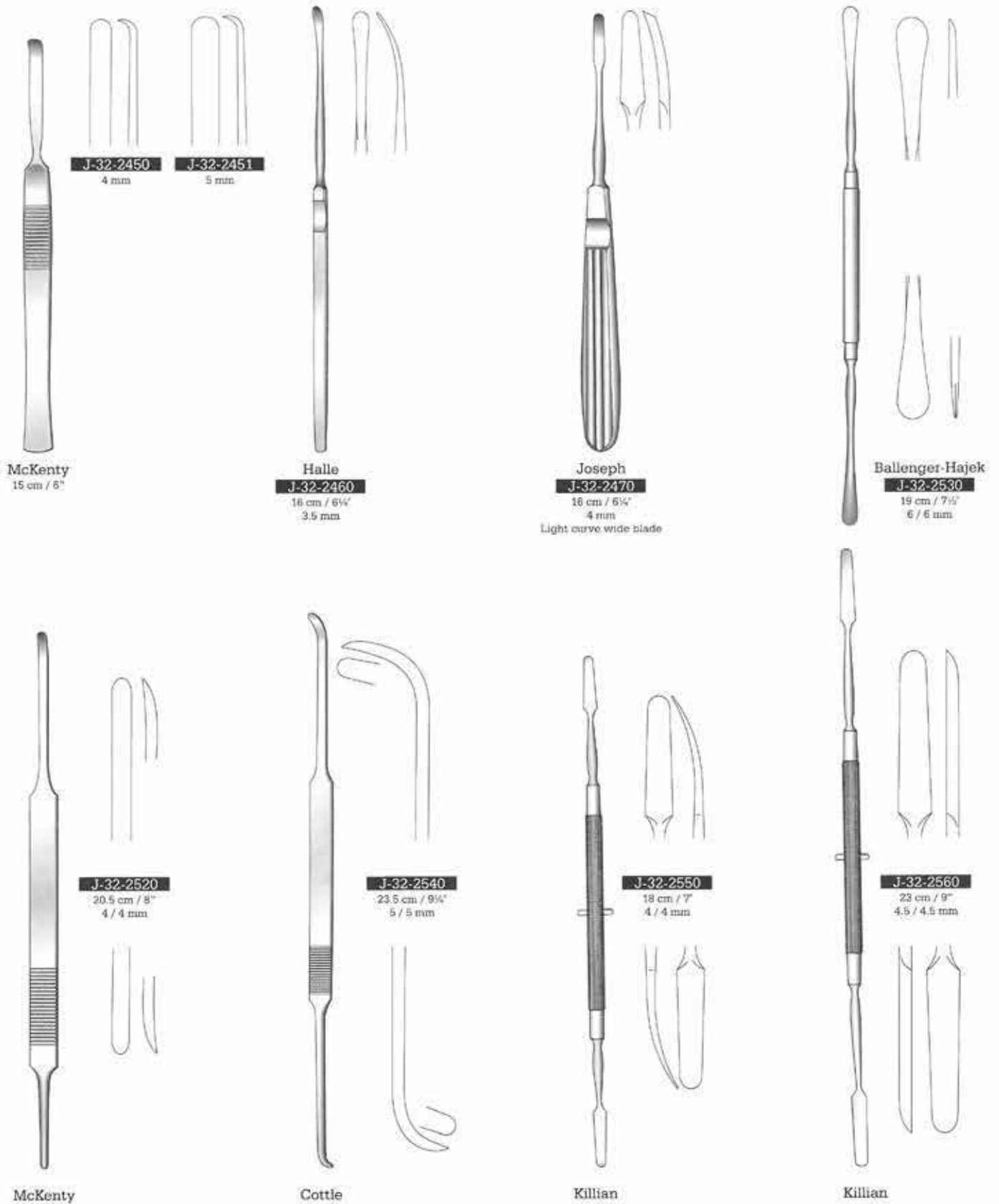

Rhinology

Septum Elevators, Periosteal Elevators

Septumelevatoren, Periostelevatoren

Elevadores para tabique nasal, Legras para periostio



J-32-2570
21.5 cm / 8 1/2"
4 / 4 mm

Pennington



J-32-2580
19.5 cm / 7 1/2"
4 / 4 mm

Roger



J-32-2590
21.5 cm / 8 1/2"
4 mm

Joseph-Masing

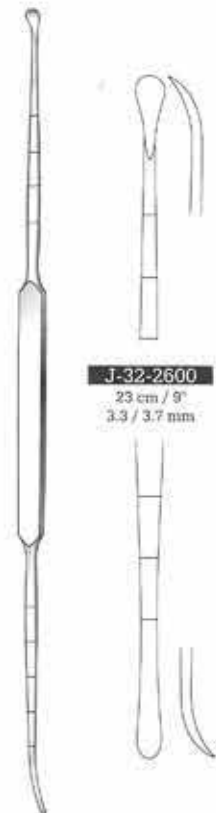

J-32-2600
23 cm / 9"
3.3 / 3.7 mm

Cottle

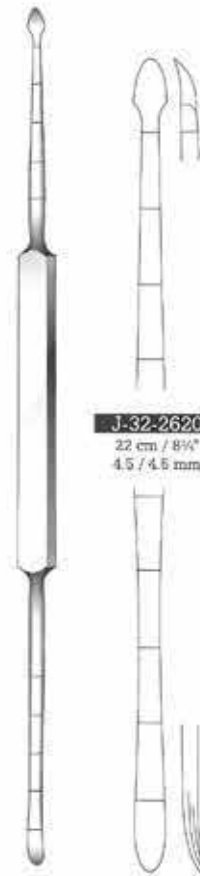

J-32-2620
22 cm / 8 3/4"
4.5 / 4.5 mm

Cottle



J-32-2610
19.5 cm / 7 1/2"
3 / 2 mm

Masing

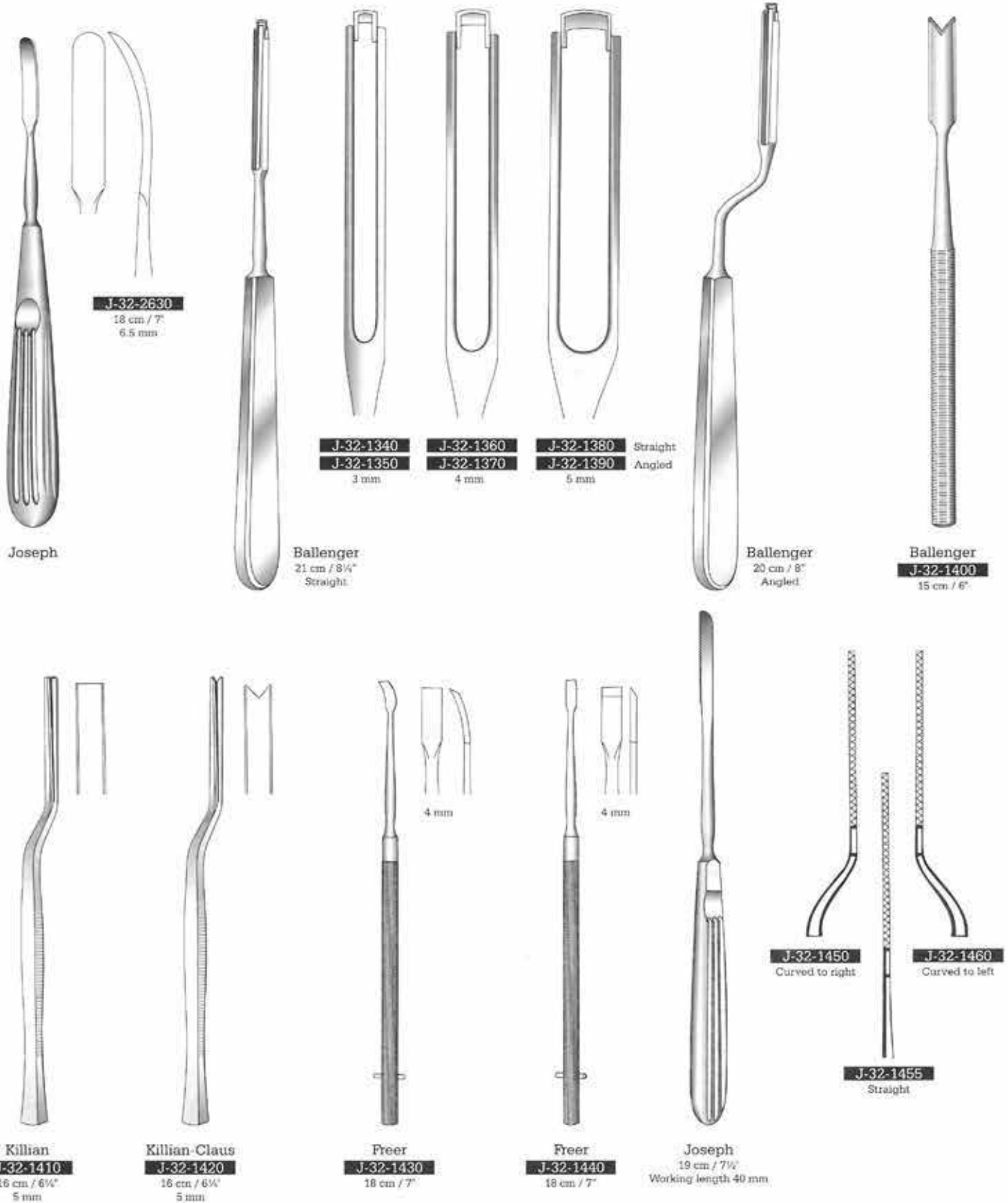

Rhinology

Septum Gouges & Periosteal Elevators, Nasal Saws
Septum-Hühmeibel und Raspatorien Nasenagen
Gubias Para Tabique nasal Y Legras, Sierras Nasaes

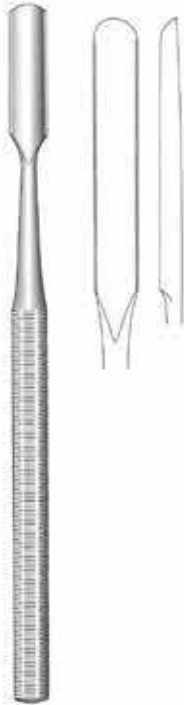

Freer
J-32-2640
15 cm / 6"
6 mm
Septum gouges



J-32-2650
18 cm / 7"
3 x 18 mm



J-32-2660
18 cm / 7"
3.5 x 23 mm



Joseph
J-32-1470
17 cm / 6 1/2"
Angled to left
Nasal knife

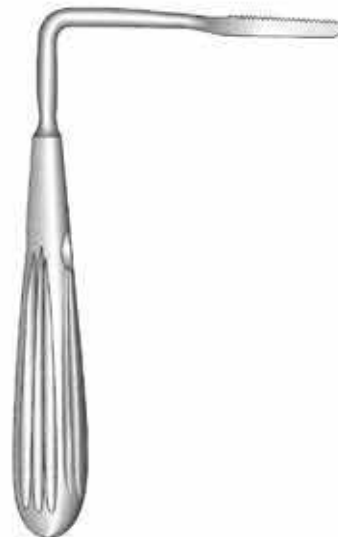

Joseph
J-32-1480
17 cm / 6 1/2"
Angled to right
Nasal knife



Tessier
 20.5 cm / 8"



J-32-2410
 12 mm



J-32-2420
 15 mm



Tessier
J-32-3500
 18.5 cm / 7 1/4"
 6 mm
 Angled 30°



Tessier
J-32-3505
 18 cm / 7"
 6 mm
 Angled 60°

Rhinology

Nasal Hooks, Nasal Retractors, Alar Hooklets

Nasenhakchen, Nasenhaken, Nasenflughakchen

Ganchitos nasales, Separadores nasales, Ganchitos para alas de nariz



Joseph
J-32-1481
15 cm / 6"
Sharp



Cottle
J-32-1482
16 cm / 6 1/4"
Sharp



Cottle
15 cm / 6"



J-32-1483
J-32-1484
J-32-1485



Kilner
J-32-1486
10 cm / 4"
Sharp



Converse
J-32-1487
12 cm / 4 1/4"
Double ended
Sharp



Freer
J-32-1488
15 cm / 6"
Sharp



Joseph
16 cm / 6 1/4"

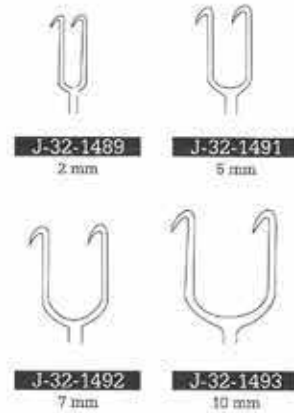

J-32-1489 2 mm
J-32-1491 5 mm
J-32-1492 7 mm
J-32-1493 10 mm



Weighted Nasal Hook
J-30-320
 Approx. weight, 2oz
 Nasal hook



Fomon
J-32-1494
 16 cm / 6 1/4"



Cottle-Neivert
J-32-1495
 20 cm / 8"

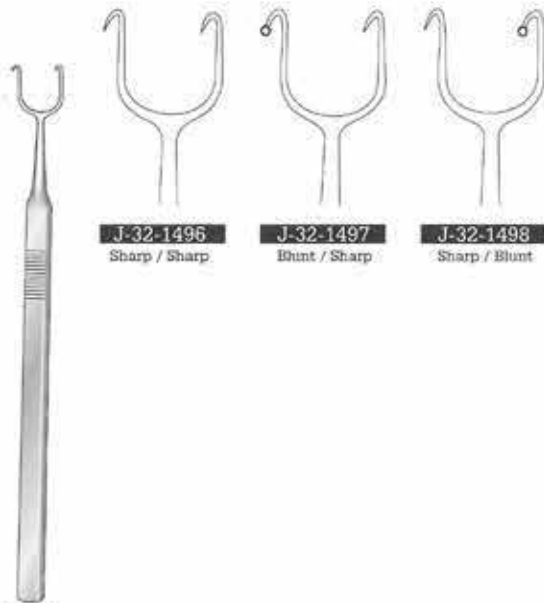

Cottle
 15 cm / 6"

J-32-1496
 Sharp / Sharp

J-32-1497
 Blunt / Sharp

J-32-1498
 Sharp / Blunt



18.5 cm / 7 1/4"



J-32-2670
 14 x 17 mm
Koberg. mod
J-32-2671
 20 x 7 mm

Rhinology

Wire Pushers, Arch Bar, Zygoma Elevators

Drahtpositionierer, Drahtbogen, Zygoma Elevatorien

Empujadores de alambres, Arco de alambre, Elevadores cigomaticos



J-32-2680
17 cm / 6 3/4"



Rowe
J-32-2685
15 cm / 6"



Mershon
J-32-2686
15 cm / 6"

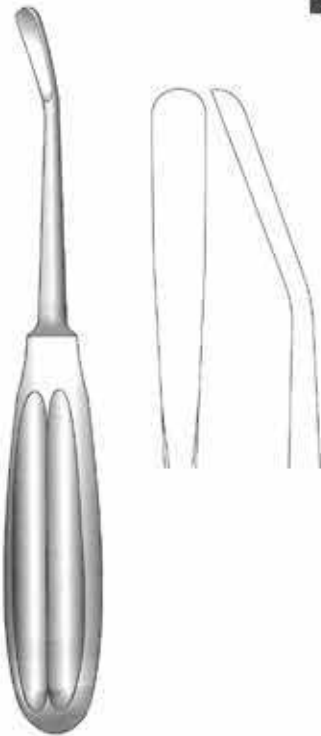

Gillies
J-32-2430
20 cm / 8"



Dingmann
J-32-2440
21 cm / 8 1/4"
Tip 5.0 mm ϕ

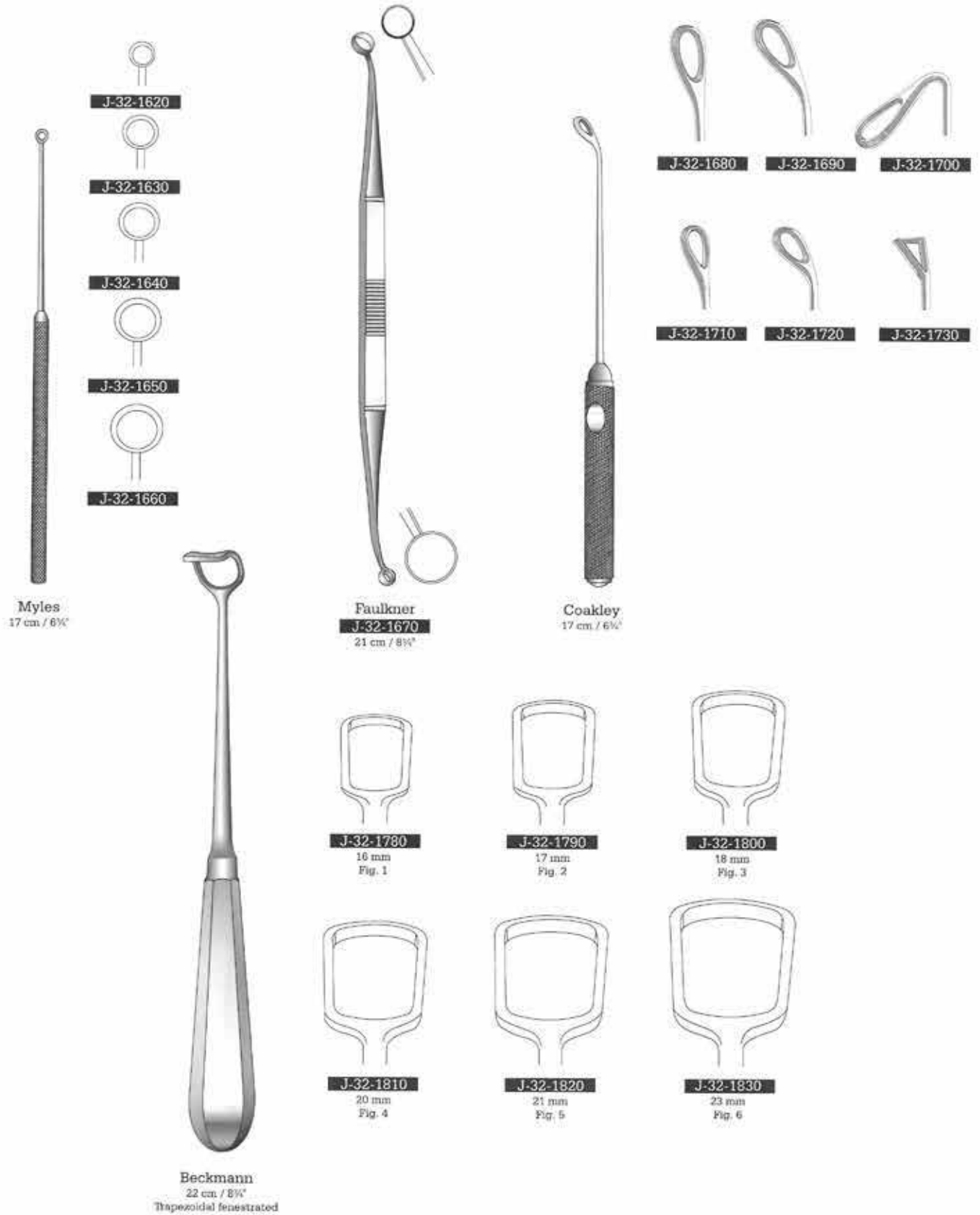

Rhinology

Adenoid Curettes, Bone Curettes, Curette Sharpener

Ringmesser, Scharfe Kuretten, Kuretzenscharfer

Cuchillos para Vegetaciones adenoides, Curetas cortantes, Afilador para curetas



Beckmann
22 cm / 8 1/2"



J-32-1840
Fig. 1



J-32-1850
Fig. 2



J-32-1860
Fig. 3



J-32-1870
Fig. 4



J-32-1880
Fig. 5

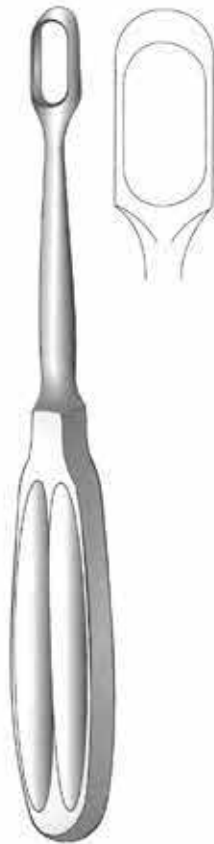

Tessier
J-32-1882
21.5 cm / 8 1/2"
12 mm



Tessier
J-32-1950
19.5 cm / 7 3/4"
Curette sharpener



Tessier
J-32-1884
21.5 cm / 8 1/2"
6 mm



St. Clair-Thomson
21 cm / 8 1/4"



J-32-1890
11 mm



J-32-1900
13 mm



J-32-1910
15 mm



J-32-1920
17 mm



Hartmann

Fig. 1	mm Ø	Fig. 2
J-32-1960	2	J-32-1990
J-32-1970	2.5	J-32-2000
J-32-1980	3	J-32-2001



Hartmann
J-32-2010 2 mm Ø
J-32-2020 2.5 mm Ø
J-32-2030 3 mm Ø
12 cm / 4 1/4"



Eicken-Killian
J-32-2040
14 cm / 5 1/2"
3 mm Ø
Irrigation cannula



Eicken-Killian
J-32-2050
14 cm / 5 1/2"
3 mm Ø



Killian
J-32-2060
17 cm / 6 1/2"
1.5 mm Ø



Marchac
J-32-2065
19 cm / 7 1/2"

Oral Maxillo Facial Surgery

Sinus Lift Currettes

Sinus Lift Kurretten

Curetas para Sinus-lift

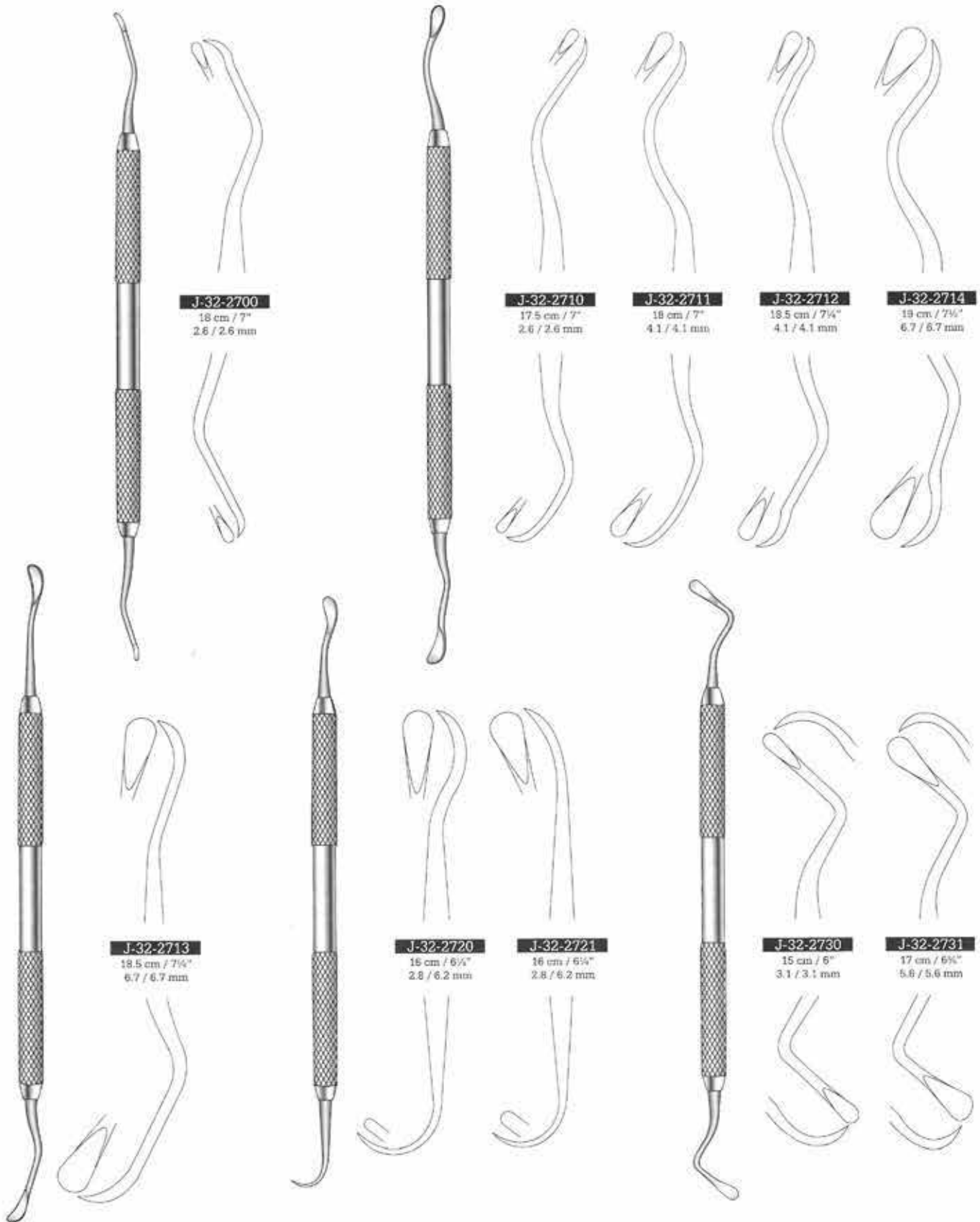

J-32-2700
18 cm / 7"
2.6 / 2.6 mm

J-32-2710
17.5 cm / 7"
2.6 / 2.6 mm

J-32-2711
18 cm / 7"
4.1 / 4.1 mm

J-32-2712
18.5 cm / 7 1/4"
4.1 / 4.1 mm

J-32-2714
19 cm / 7 1/2"
6.7 / 6.7 mm

J-32-2713
18.5 cm / 7 1/4"
6.7 / 6.7 mm

J-32-2720
15 cm / 6 1/4"
2.8 / 6.2 mm

J-32-2721
16 cm / 6 1/4"
2.8 / 6.2 mm

J-32-2730
15 cm / 6"
3.1 / 3.1 mm

J-32-2731
17 cm / 6 3/4"
5.6 / 5.6 mm

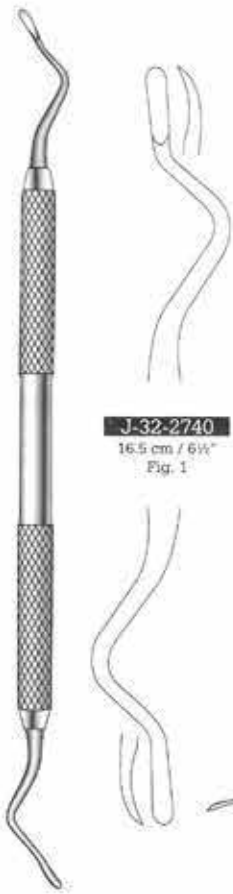

J-32-2740
16.5 cm / 6 1/2"
Fig. 1

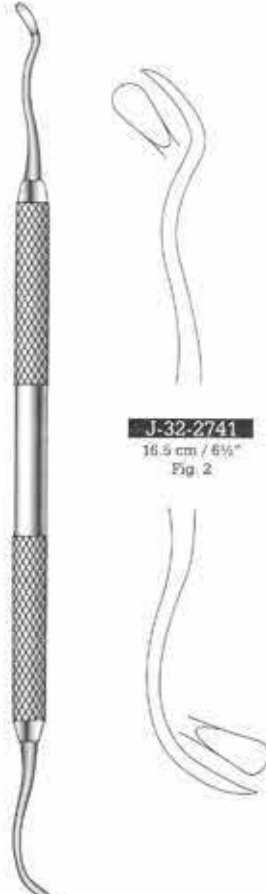

J-32-2741
16.5 cm / 6 1/2"
Fig. 2



J-32-2742
14 cm / 5 1/2"
Fig. 3

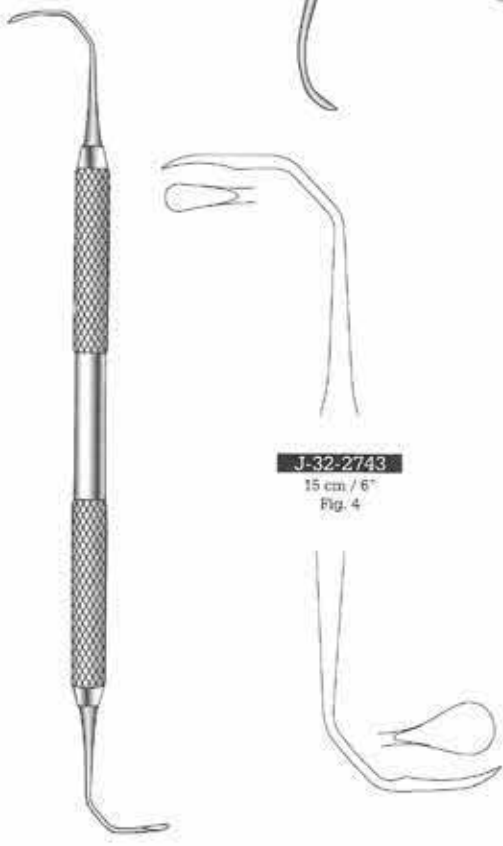

J-32-2743
15 cm / 6"
Fig. 4

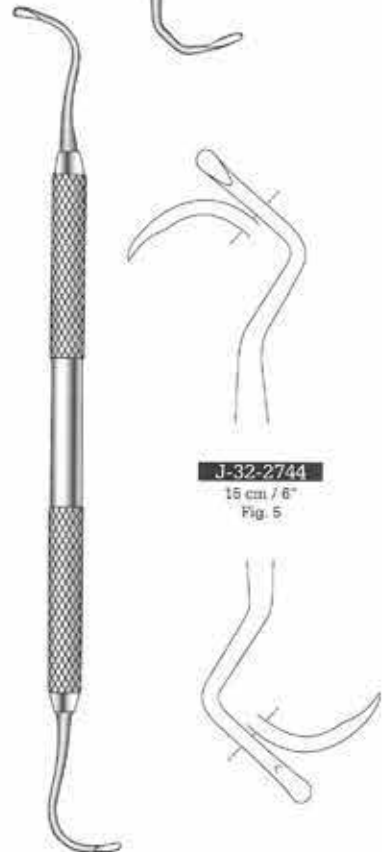

J-32-2744
15 cm / 6"
Fig. 5

Rhinology

Glabella Rasps, Nasal Rasps, Bone Files
 Glabellaraspeln, Nasenraspel, Knochenfeilen
 Escofinas para glabella, nasales, Limas Para Huesos



Aufricht
 21 cm / 8 1/4"



JO-21-191
 Single ended
 forward cutting
 32 x 9 mm



JO-21-192
 Single ended
 backward cutting
 32 x 9 mm



Joseph
JO-21-194
 16 cm / 6 1/4"
 60 x 8 mm
 Single ended, 8 mm at wide
 point, fine cross serrations



Lewis
 19 cm / 7 1/2"

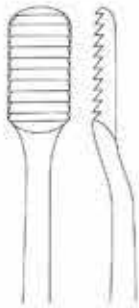

JO-21-195
 Fine, single ended
 15 x 8 mm

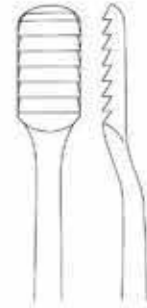

JO-21-196
 Coarse, single ended
 15 x 8 mm
 Plain serrations



Cottle
JO-21-197
 21 cm / 8 1/4"
 30 x 8 mm



Gallaher
 17 cm / 6 3/4"



J-32-1535
 45 x 6 mm



J-32-1536
 45 x 6 mm

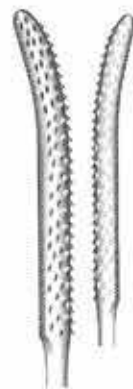

J-32-1537
 45 x 6 mm



Fomon
JO-21-189
 21 cm / 8 3/4"
 Double ended, fine and coarse teeth; 4-side, convex and flat blades 30 x 8 mm

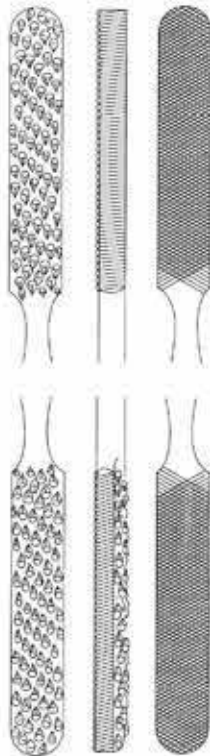

Maltz
 18 cm / 7"
 Single ended
 10 mm width

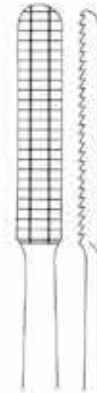

JO-21-193
 34 x 7 mm
 Backward cutting

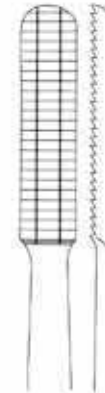

J-21-1541
 34 x 7 mm
 Forward cutting



Wiener
 18 cm / 7"



J-32-1520



J-32-1530

Rhinology

Rhinoplastic Chisels & Osteotomes

Nasenmeißel und Osteotome

Cinceles nasales Y Osteotomos



Silver
J-32-1571
18 cm / 7"
Straight



Silver
J-32-1572
18 cm / 7"
Right



Silver
J-32-1573
18 cm / 7"
Left



J-32-1574
4 mm

J-32-1575
7 mm

J-32-1576
9 mm

J-32-1577
12 mm

Cottle
18 cm / 7"
Osteotome



Cottle
J-32-1578
18 cm / 7"
Osteotome



Parkes
J-32-2800
16 cm / 6 1/4"



Cottle
18 cm / 7"
T Handle osteotome
Very delicate



J-32-1579
4 mm



J-32-1581
7 mm



J-32-1582
9 mm



J-32-1583
12 mm



Cottle
J-32-1584
19 cm / 7"

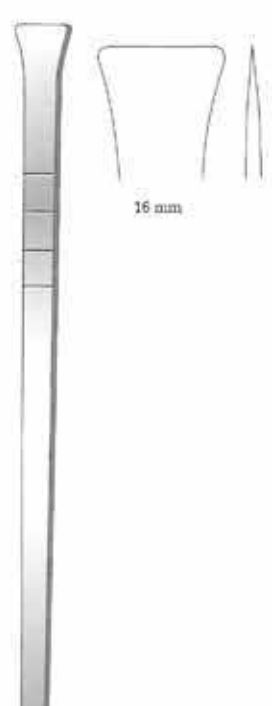

Cottle
J-32-1585
18 cm / 7"
Fish-tail osteotome
Very delicate

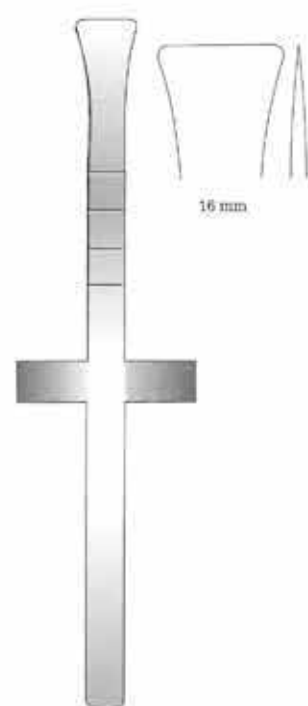

Cottle
J-32-1586
18 cm / 7"

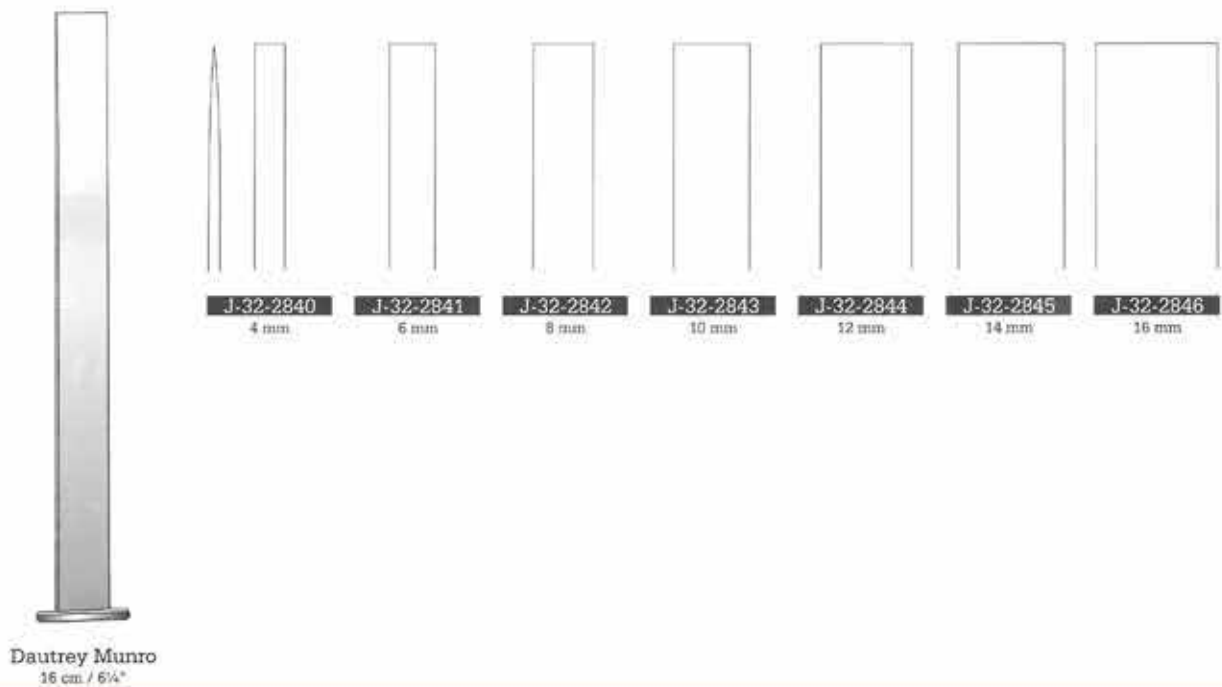
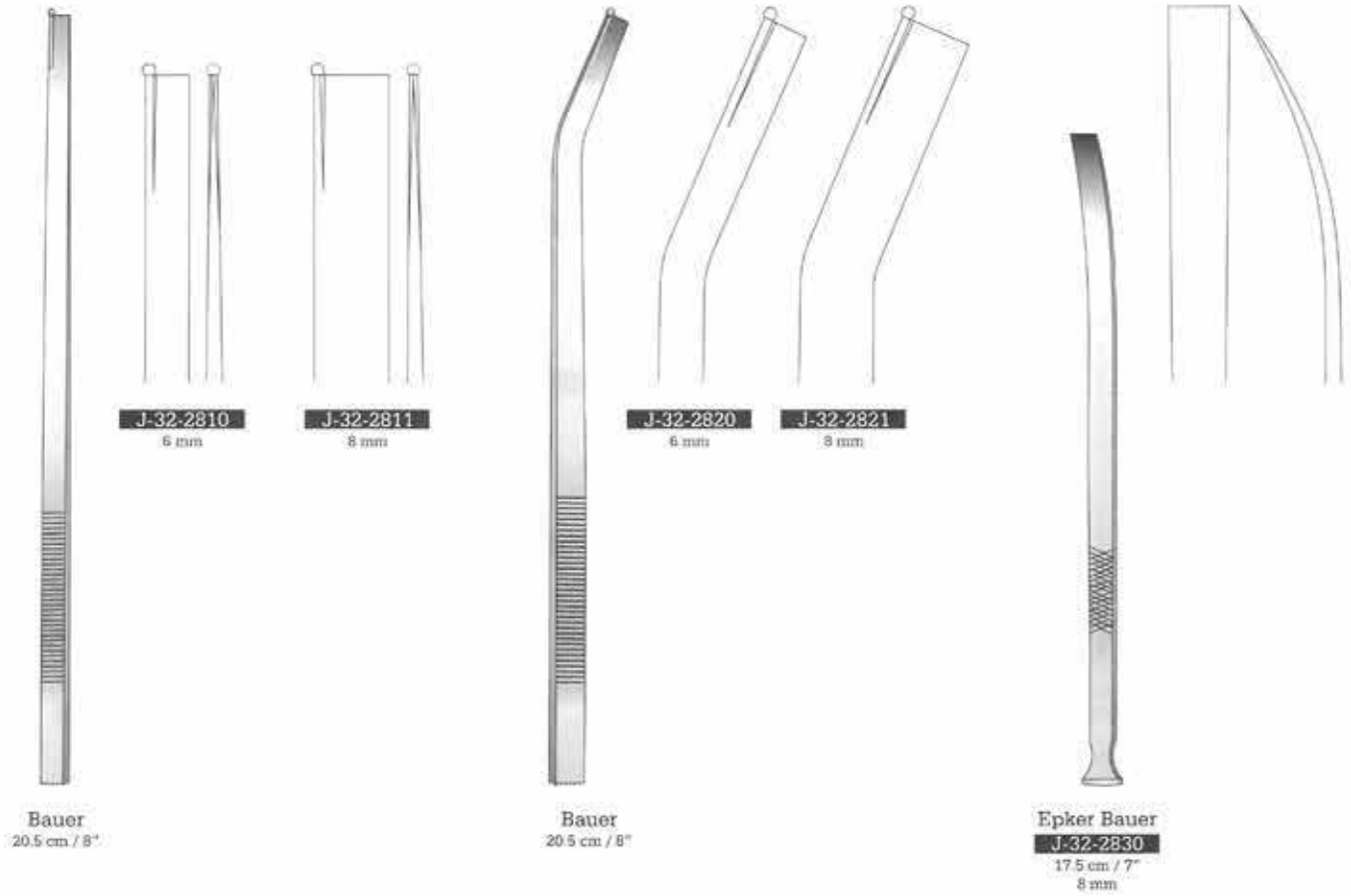

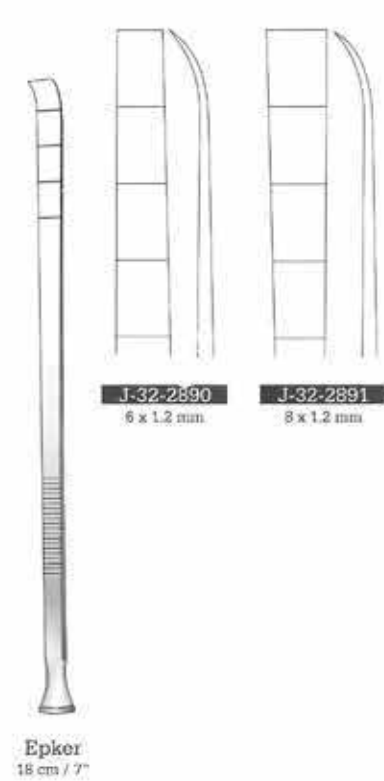
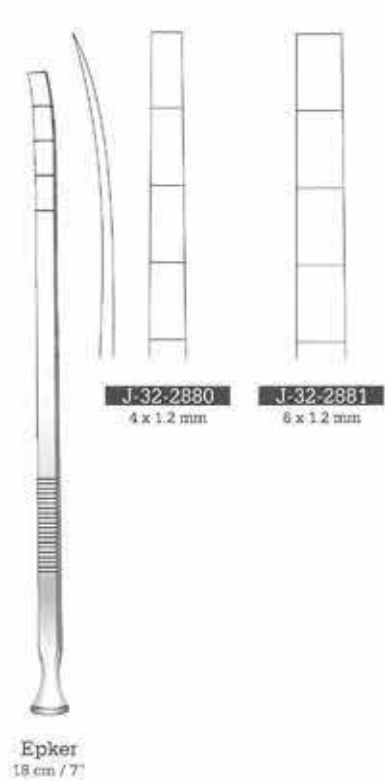
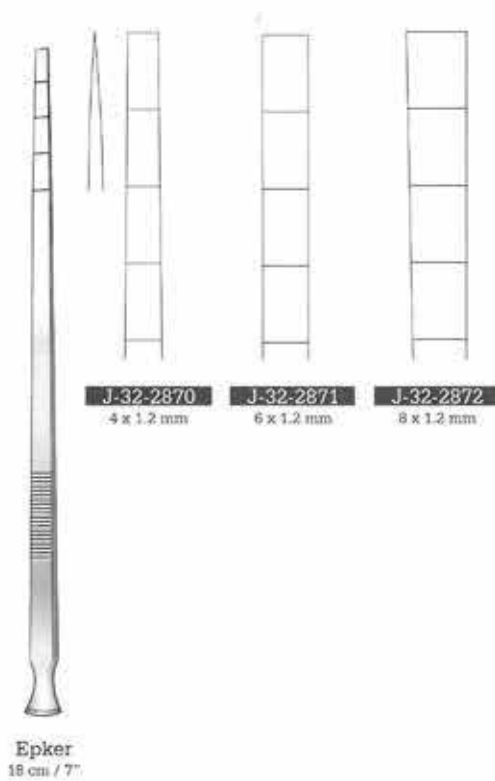
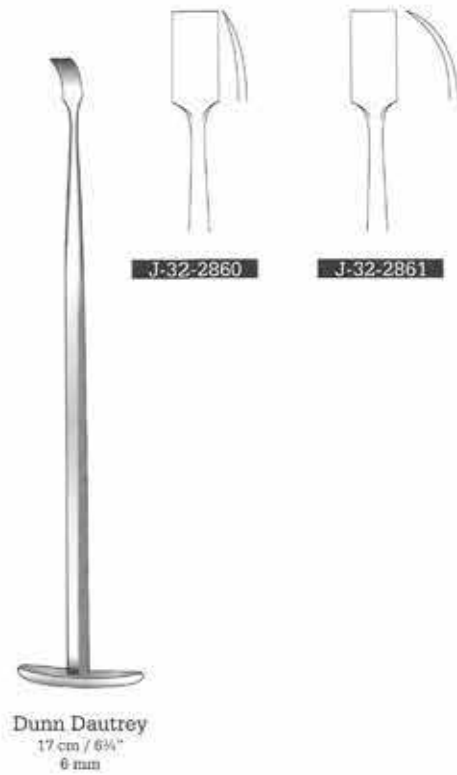

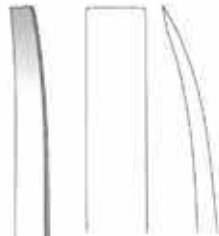

J-32-3440
8 mm

Obwegeser
23.5 cm / 9 1/4"

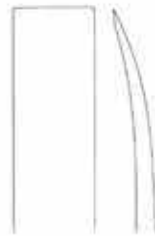

J-32-3445
11 mm



J-32-2960
22 cm / 8 3/4"

Hargis



Terry
J-32-2900
17 cm / 6 3/4"



Terry
J-32-2910
19 cm / 7 1/2"



Terry
J-32-2930
14 cm / 5 1/2"
Occlusal wedge



Terry
J-32-2940
15 cm / 6"
Left



Terry
J-32-2950
15 cm / 6"
Right

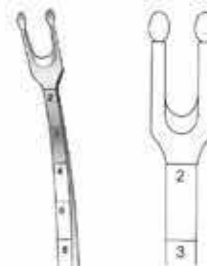

J-32-2920
4 mm



J-32-2921
6 mm

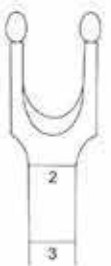

J-32-2922
8 mm



Obwegeser
18.5 cm / 7 1/4"
Graduated

Rhinology

Ramus Osteotomes, Chisels
Ramusosteotome, MeiBel
Osteotomos de rama, Cinceles

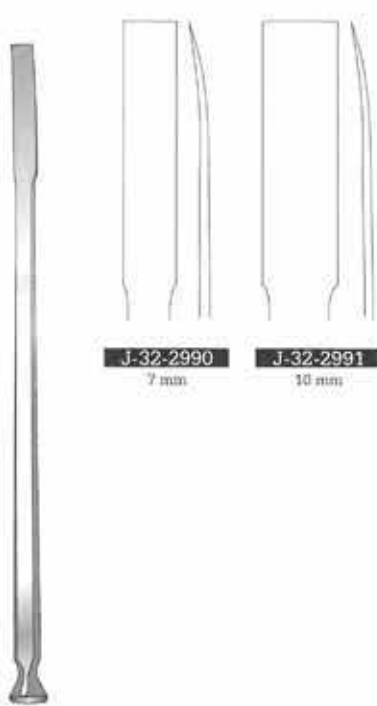

Steinhauser
17 cm / 6 3/4"
Flexible

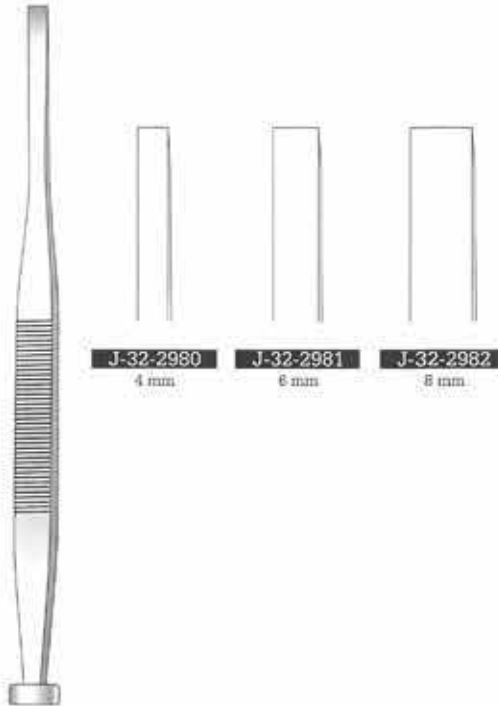

Marchac
18.5 cm / 7 1/4"



Marchac
J-32-3520
18.5 cm / 7 1/4"
6 mm
Curved

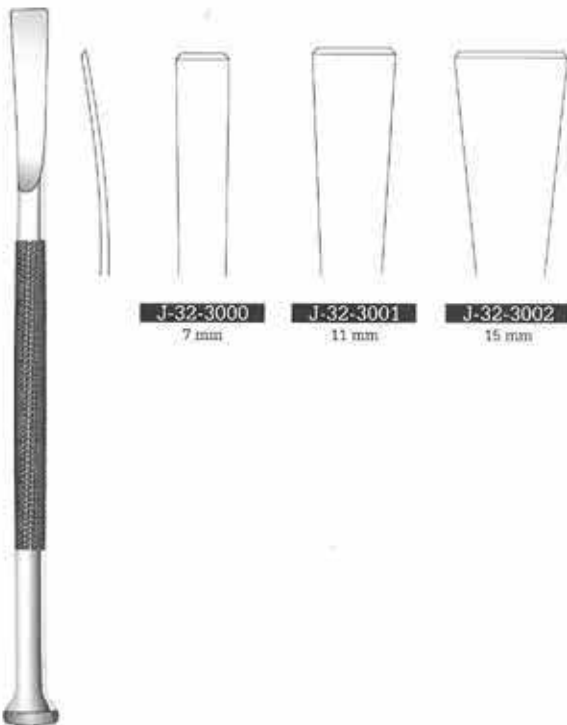

Steinhauser
19 cm / 7 1/2"
Flexible

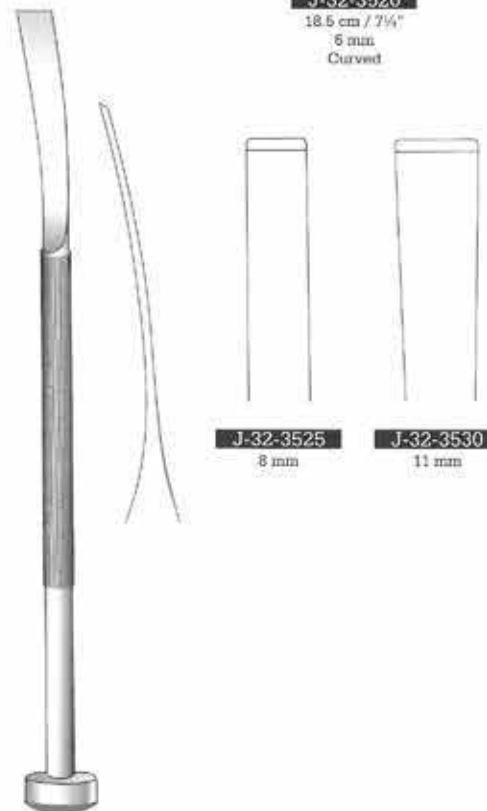

Obwegeser
21 cm / 8 1/4"
Elastic blade



Steinhauser

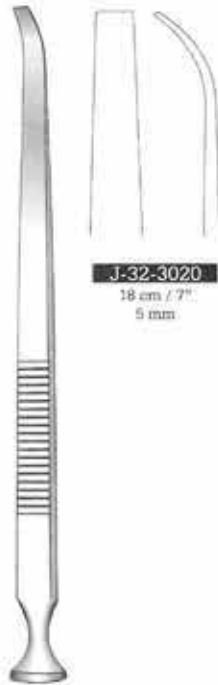

Steinhauser



Steinhauser



Wolford
23 cm / 9"



J-32-3040
6 mm

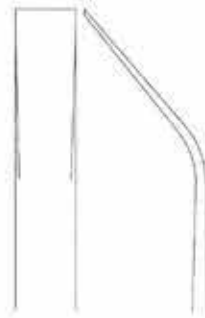

J-32-3041
8 mm



Obwegeser
J-32-2970
23 cm / 9"
12 mm

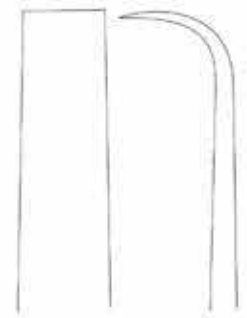

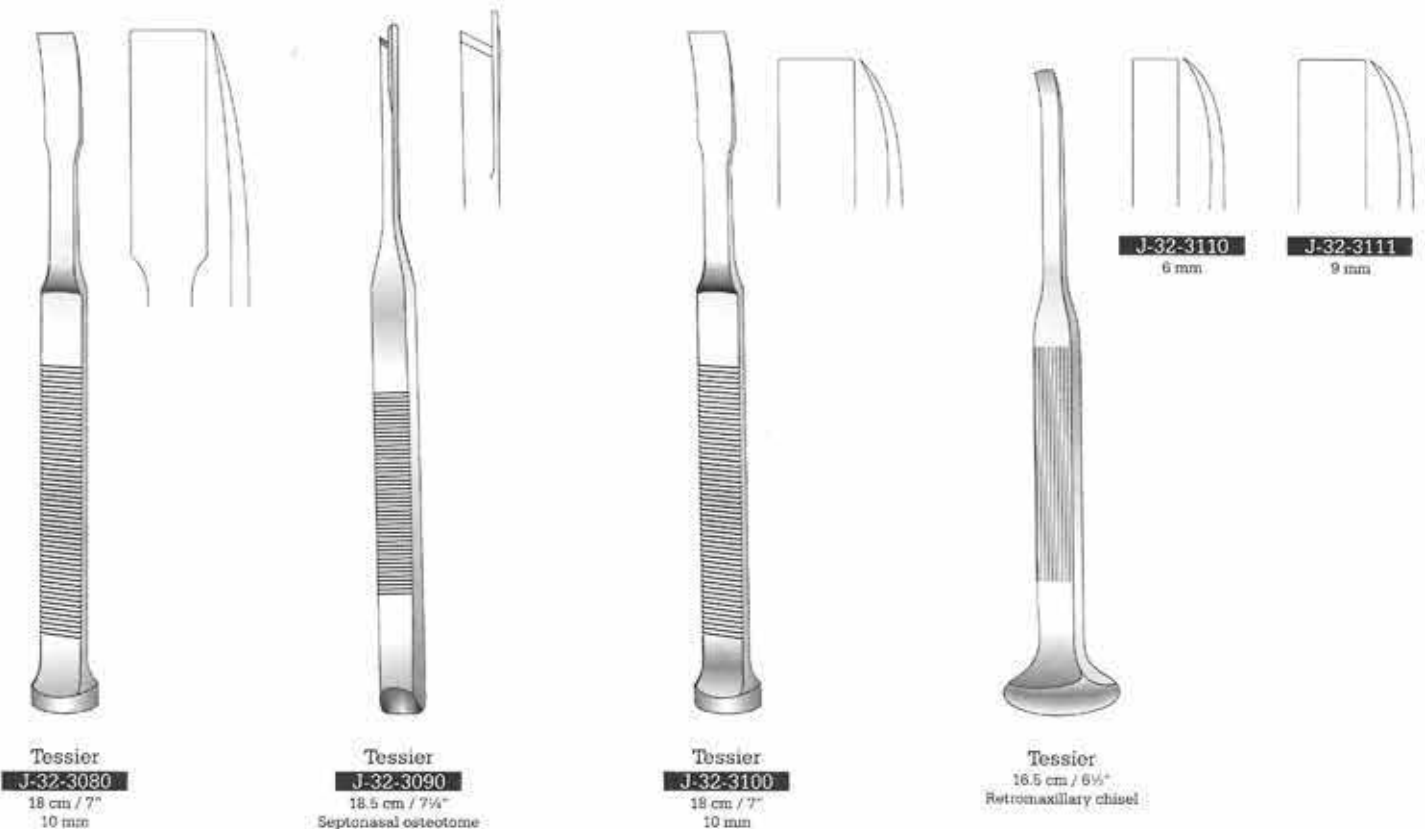
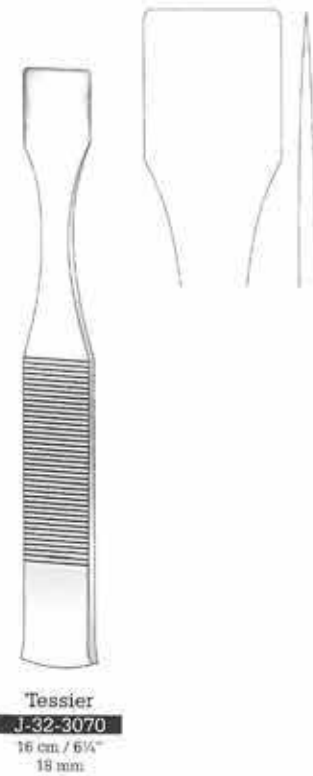
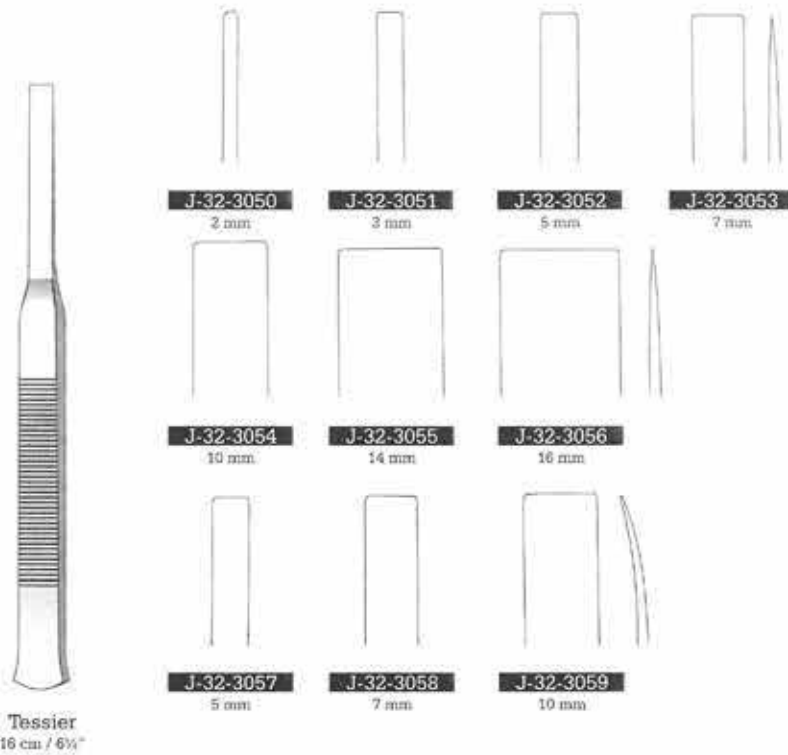



Neivert-Anderson
 20.5 cm / 8"



J-32-3670
 4 mm
J-32-3675
 7 mm

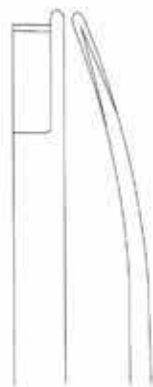

J-32-3680
 4 mm
J-32-3685
 7 mm



J-32-3690
 4 mm
J-32-3695
 7 mm



Fomon
 17 cm / 6 3/4"

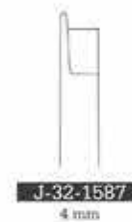

J-32-1587
 4 mm



J-32-1588
 5 mm



J-32-1589
 6 mm



J-32-1591
 7 mm



Sheehan
 15 cm / 6"

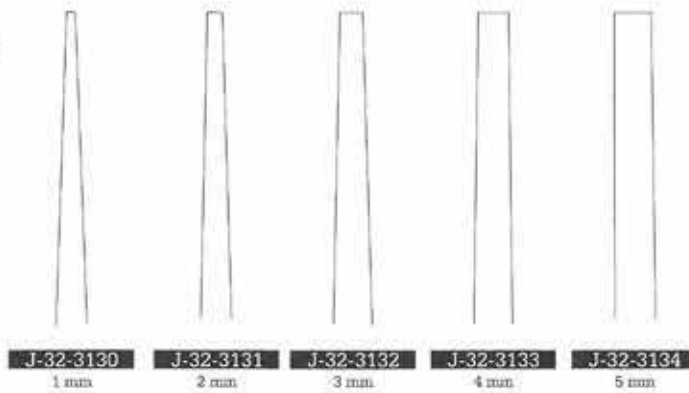

J-32-3130 1 mm **J-32-3131** 2 mm **J-32-3132** 3 mm **J-32-3133** 4 mm **J-32-3134** 5 mm

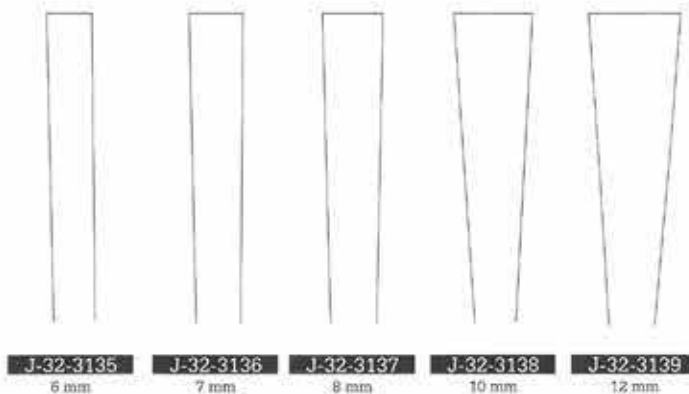

J-32-3135 6 mm **J-32-3136** 7 mm **J-32-3137** 8 mm **J-32-3138** 10 mm **J-32-3139** 12 mm



Cinelli
 16 cm / 6 1/4"
 Osteotome
 Double guarded

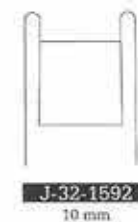

J-32-1592
 10 mm



J-32-1593
 12 mm



J-32-1594
 14 mm



J-32-1595
 16 mm

Rhinology

Alar Hooklets, Nasal Retractors

Nasenflügelhakchen, Nasenhaken

Ganchitos para alas de nariz, Separadores nasales



Cottle
J-32-1596
14 cm / 5 1/2"
Alar hooklets

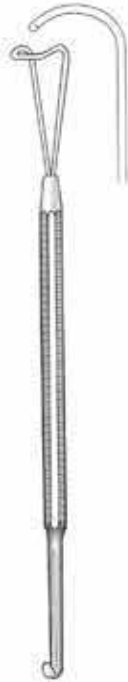

Neivert
J-32-1597
16 cm / 6 1/4"



Cottle
J-32-1598
15 cm / 6"
Saddle hook



Becker
J-32-3400 Small
J-32-3401 Medium
J-32-3402 Large
J-32-3403 X Large
12 cm / 4 3/4"
Plastic surgery, american made
open retractors



Anderson
Three prong
J-32-3410
12 cm / 4 3/4"
Short
J-32-3412
16 cm / 6 1/4"
Long
Plastic surgery, american
made retractor



Anderson
Five prong
J-32-3411
12 cm / 4 3/4"
Short
J-32-3413
16 cm / 6 1/4"
Long
Plastic surgery, american
made retractor



Cottle
J-32-1599
15 cm / 6"



Aufricht
J-32-1601
13.5 cm / 5 1/4"
60 x 6.5 mm blade
blunt

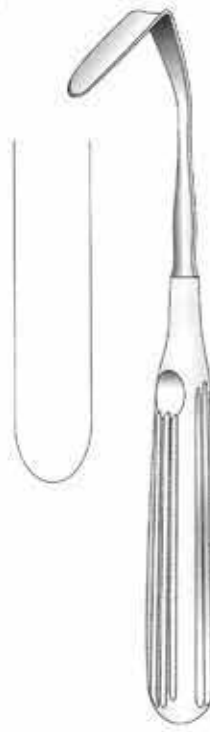

Aufricht
J-33-800 19 cm / 7 1/2"
40 x 12 mm blade
J-33-801 16 cm / 6 1/4"
45 x 6 mm blade



Aufricht
J-33-1390
11 cm / 4 1/4"
50 x 6 mm

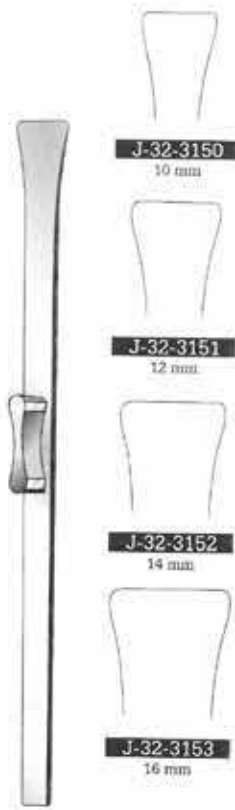

Rubin
 19.5 cm / 7 1/4"
 Osteotomes



Walter
 19 cm / 7 1/2"

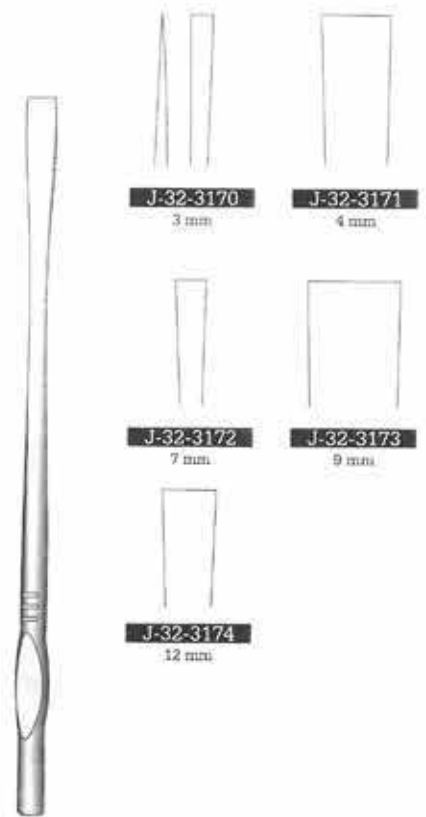

Walter
 19 cm / 7 1/2"



Cottle
J-32-3180
 12 cm / 4 3/4"
 Handle



Cottle
J-32-3190
 7 mm width
 Guide support for osteotomes

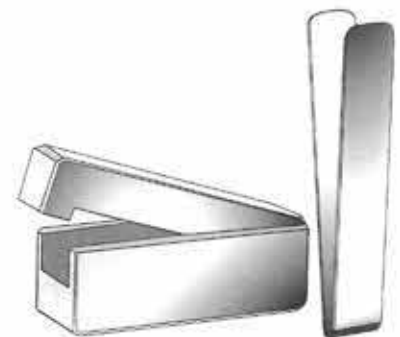

Cottle
J-32-3200
 65 x 30 x 30 mm
 Cartilage crusher

Rhinology

Septum Forceps, Septum Straightening Forceps, Skin Grasping Forceps

Septumzangen, Septumrichtzangen, Hautfasspinzetten

Pinzas para tabique nasal, Pinzas para enderezar el tabique nasal, Pinzas para piel

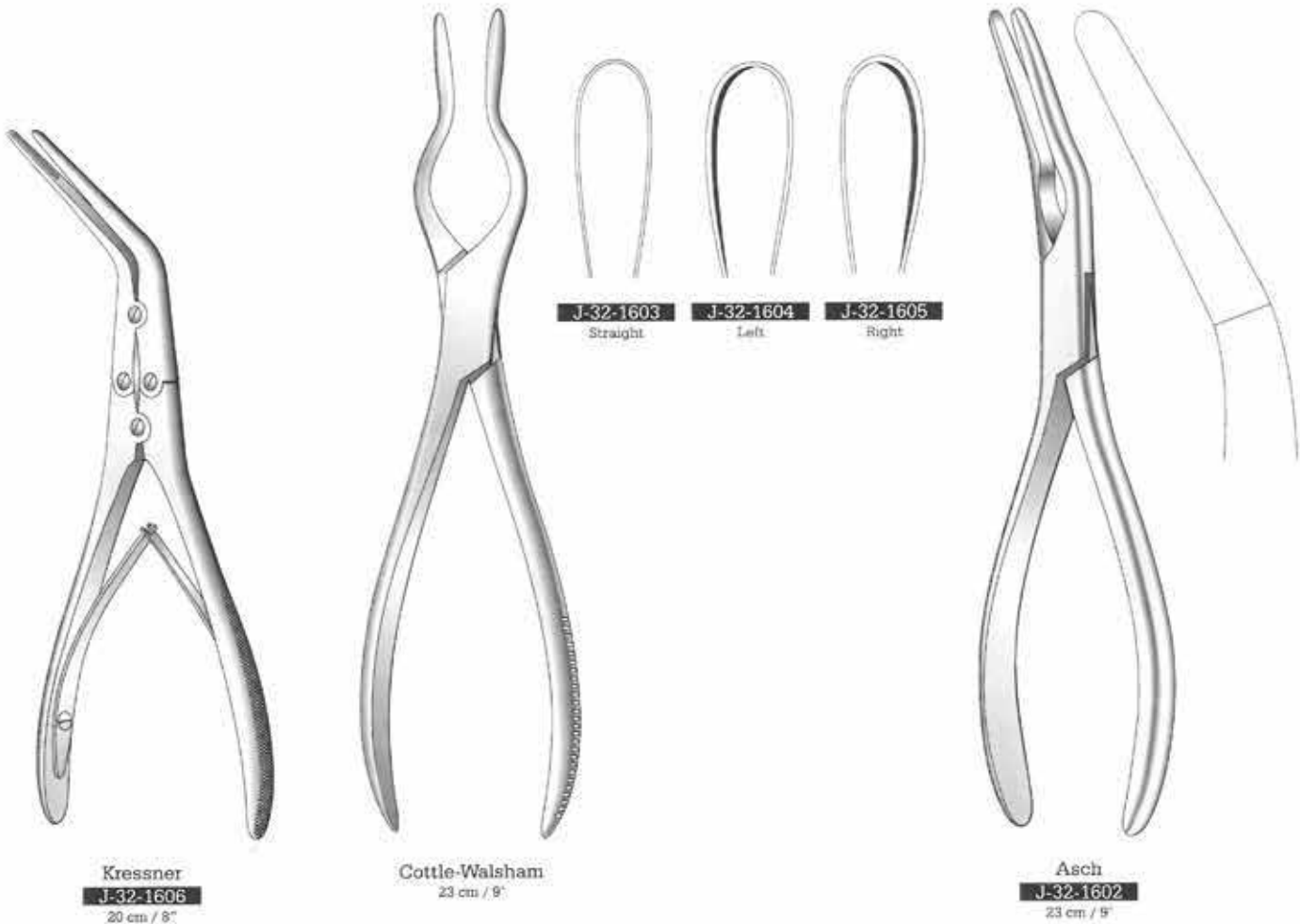

Kressner
J-32-1606
20 cm / 8"

Cottle-Walsham
23 cm / 9"

Asch
J-32-1602
23 cm / 9"



Ogura
J-32-1607
11 cm / 4 1/4"
4 mm wide

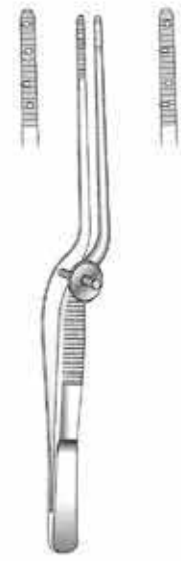

Cottle
J-32-1608
14 cm / 5 1/2"
1.7 mm wide with teeth

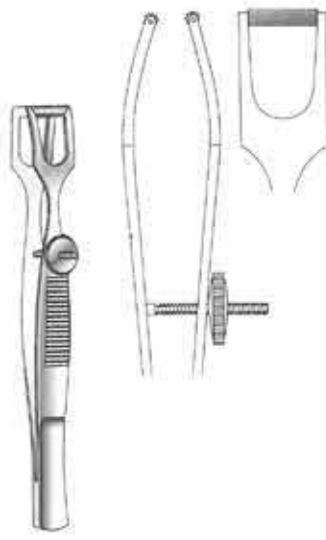

Cottle
J-32-1609
11 cm 4 1/4"
12 mm wide
Columella forceps



Aiach
J-32-1611
15.5 cm / 6"
5 mm wide
Columella suturing forceps



LaRoe Tissue Spreaders
J-32-3420 Straight
J-32-3421 Curved
23 cm / 9"
Small
J-32-3425 Tapered, mod.
J-32-3426 Curved
26 cm / 10¼"
Large

Rhinology

Disimpaction Forceps
Repositionszangen
Pinzas para reposicion



J-32-3210 Left
J-32-3211 Right

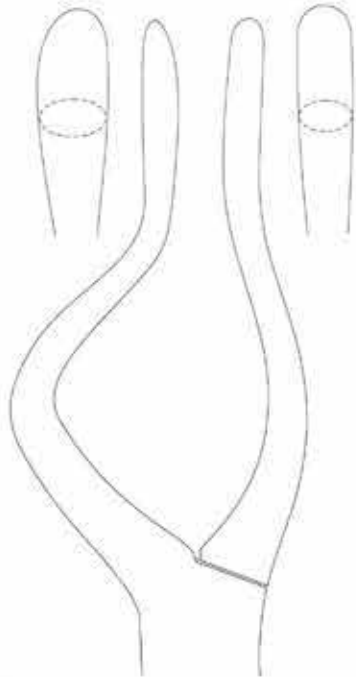

J-32-3220 Left
J-32-3221 Right

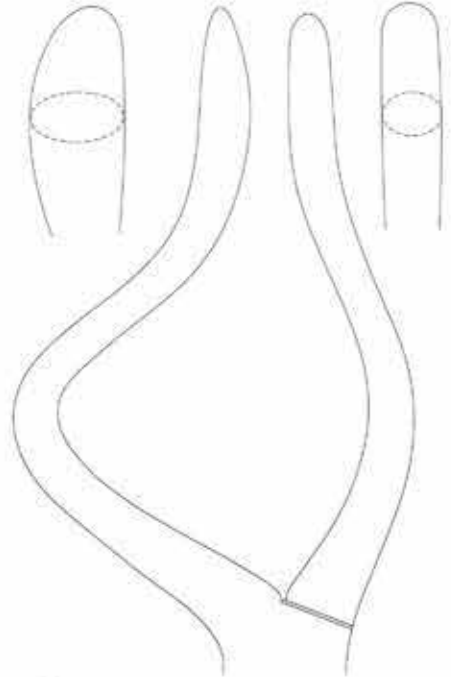

J-32-3230 Left
J-32-3231 Right



Rowe
22.5 cm / 9"
Left



Rowe
24 cm / 9 1/2"
Right

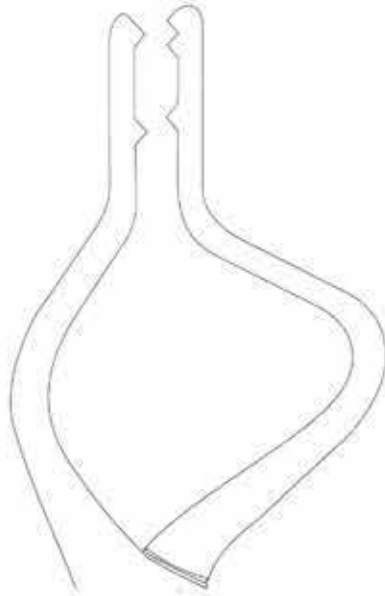

Tessier
J-32-3250
 Left
 23 cm / 9"
 For Adults

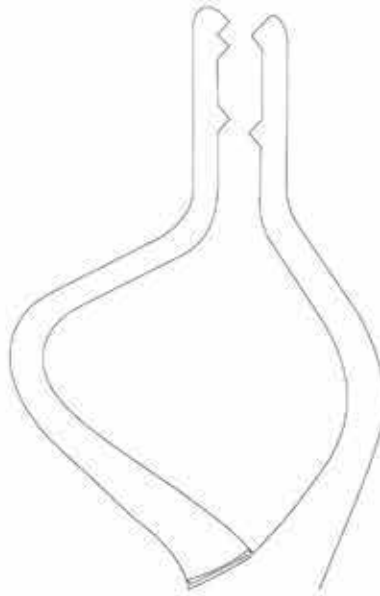

Tessier
J-32-3251
 Right
 23 cm / 9"
 For Adults

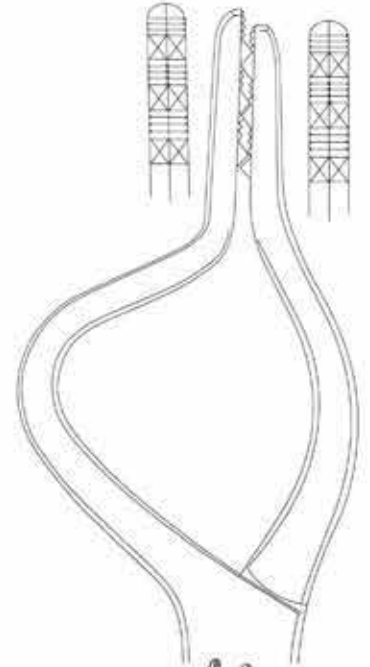

Marchac
J-32-3260
 23 cm / 9"
 For children

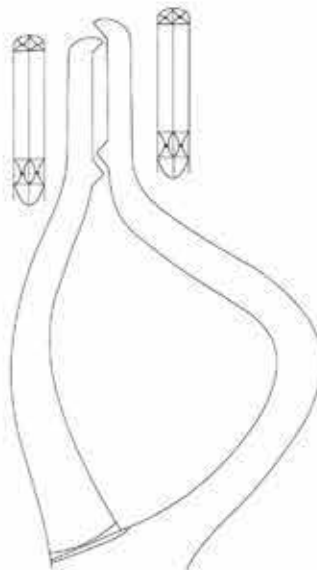

Tessier
J-32-3240
 Left
 22 cm / 8 3/4"
 For children

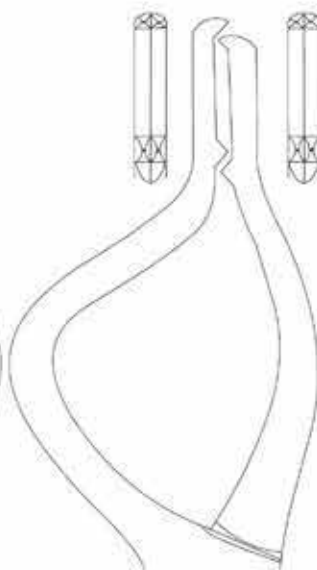

Tessier
J-32-3241
 Right
 22 cm / 8 3/4"
 For children



Tessier
 23 cm / 9"
 For adults

Oral Instruments

Mouth Gags
Mundsperrer
Abre bocas



Molt / Doyen
J-33-001
11 cm / 4 1/4"



Molt / Doyen
J-33-010
14 cm / 5 1/2"



Denhart
J-33-020
12 cm / 4 3/4"
16 mm jaw



Roser-Konig

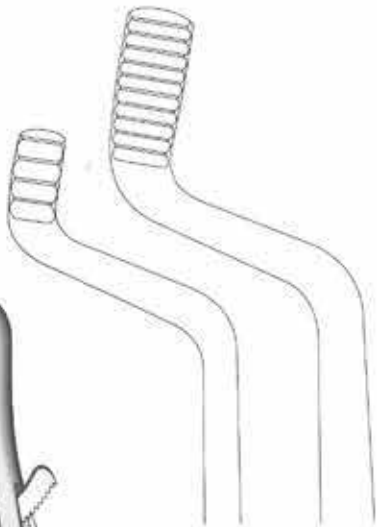

J-33-030
16 cm / 6 1/4"

J-33-040
19 cm / 7 1/2"

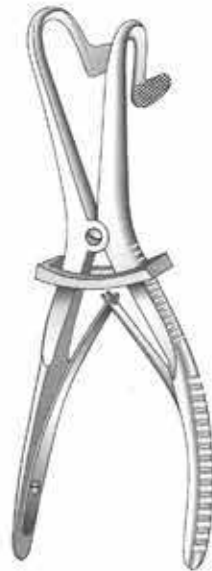

Fergusson

J-33-050 16 cm / 6 1/4"
J-33-060 19 cm / 7 1/2"
Ackland jaws

J-33-070
J-33-080
Parallel jaws



Mason

J-33-090 16 cm / 6 1/4"
J-33-100 19 cm / 7 1/2"
Ackland jaws

J-33-110
J-33-120
Parallel jaws

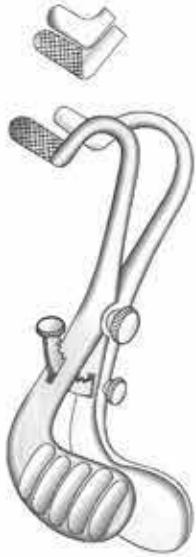

Buxton
J-33-130 Aekland jaws
J-33-140 Parallel jaws



Heister
J-33-150
 13 cm / 5"



Delabarre
J-33-045
 20 cm / 8"



Terrier
J-33-041 Straight
J-33-042 Curved
 20 cm / 8"

Oral Instruments

Mouth Gags
Mundsperrer
Abre bocas



J-33-159
Frame only



Davis Boyle
J-33-181

Complete set with frame & 5 blades

J-33-160
27 x 105 mm



J-33-170
25 x 90 mm



J-33-180
25 x 75 mm



J-33-190
22 x 60 mm



J-33-191
20 x 25 mm



Kilner Doughty
J-33-185

Complete with frame, 3 tongue depressors,
2 tooth plates and 1 palate plate



J-33-186
13.5 cm / 5 1/4"
70 x 20 mm



J-33-187
13.5 cm / 5 1/4"
80 x 34 mm



J-33-188
13.5 cm / 5 1/4"
85 x 38 mm



J-33-189
14.5 cm / 5 3/4"
Frame only for mouth gag



Mclovr
J-33-196
 15 cm / 6"
 65 x 100 mm
 Frame for mouth gag

J-33-195
 Complete with frame
 and 3 tongue blades



Mclovr
J-33-197
 13.5 cm / 5 1/4"
 100 x 26 mm
 Tongue depressor



Mclovr
J-33-198
 13.5 cm / 5 1/4"
 85 x 25 mm
 Tongue depressor



Mclovr
J-33-199
 13.5 cm / 5 1/4"
 75 x 23 mm
 Tongue depressor

Oral Instruments

Mouth Gags
Mundsperrer
Abrebecas

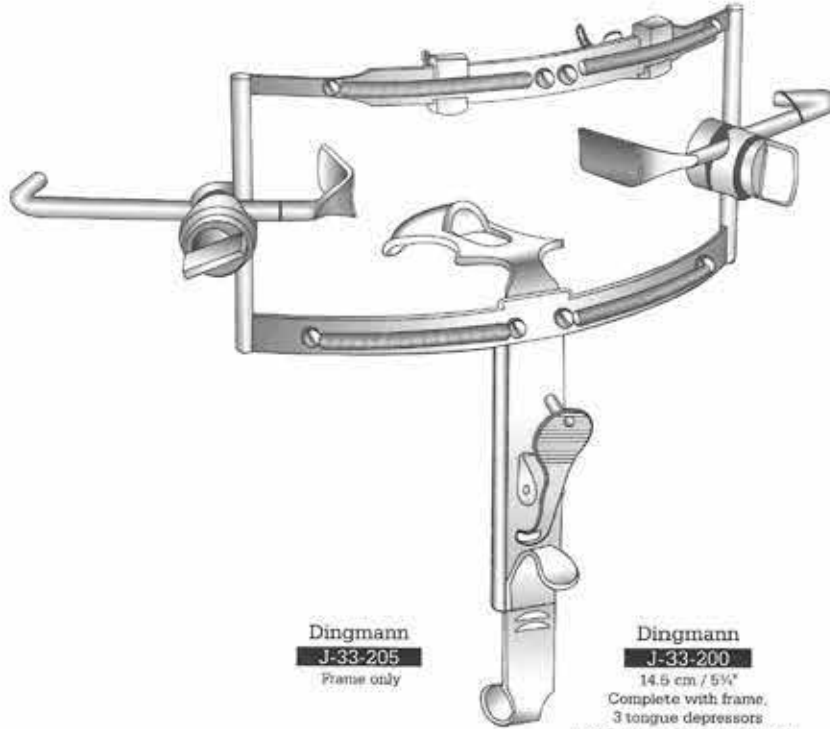

Dingmann
J-33-205
Frame only

Dingmann
J-33-200
14.5 cm / 5 7/8"
Complete with frame,
3 tongue depressors
and 2 adjustable lateral blades



Dingmann
J-33-201
13.5 cm / 5 1/4"
65 x 25 mm
Tongue depressor



Dingmann
J-33-202
13.5 cm / 5 1/4"
70 x 29 mm
Tongue depressor

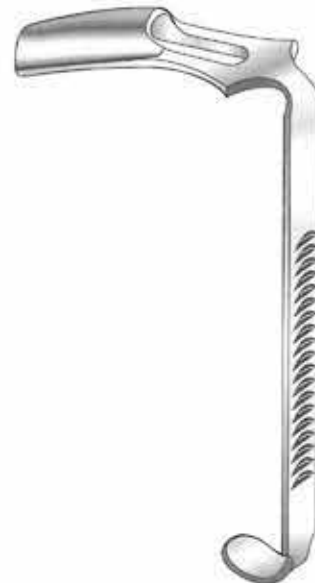

Dingmann
J-33-203
13.5 cm / 5 1/4"
80 x 32 mm
Tongue depressor



Jenning
J-33-280 9 cm / 3½"
J-33-290 11 cm / 4¼"
J-33-300 13 cm / 5"
J-33-310 15 cm / 6"

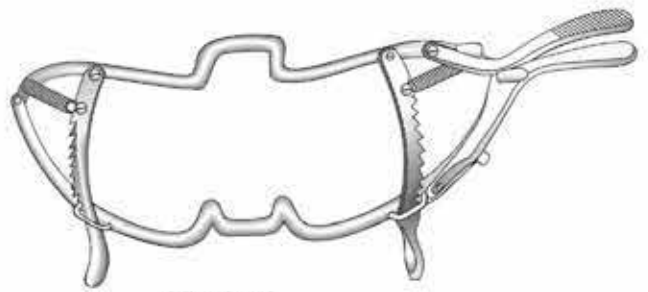

Whitehead
J-33-220 11 cm / 4¼"
J-33-230 13 cm / 5"
J-33-240 15 cm / 6"

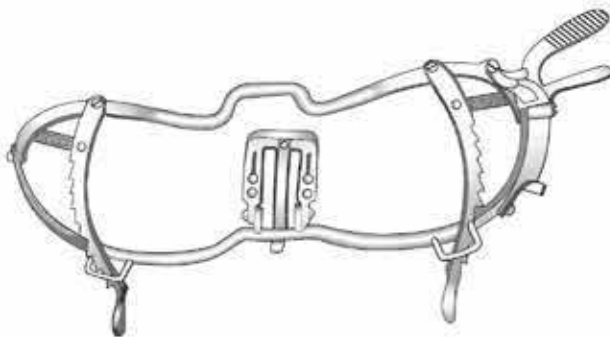

Whitehead
J-33-250 11 cm / 4¼"
J-33-260 13 cm / 5"
J-33-270 15 cm / 6"



Langenbeck
J-33-320



Langenbeck
J-33-330



Langenbeck
J-33-340

Oral Instruments

Lip and Cheek Re-tractors

Lippen- u. Wangenhalter

Sepaxadores para labios Y mejillas

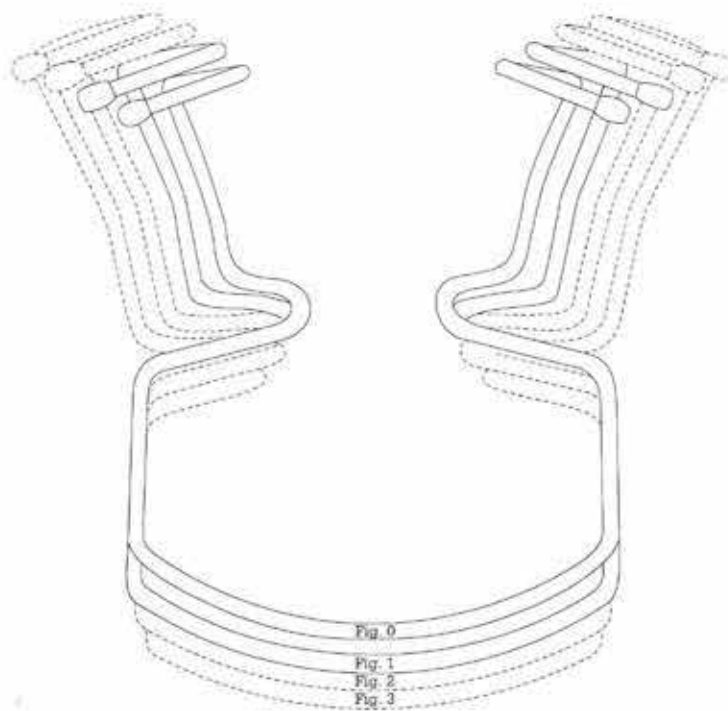

Oriinger
Self retaining

J-33-345	9.5 cm / 3 7/8"	95 mm, Fig. 0
For children		
J-33-346	10 cm / 4"	110 mm, Fig. 1
J-33-347	10.5 cm / 4 1/8"	115 mm, Fig. 2
J-33-348	11 cm / 4 3/8"	120 mm, Fig. 3
J-33-349	Set of 4, Fig 0 -Fig.3	



Tobold
J-33-350
 12 cm / 4 3/4"



Mayo
J-33-360
 17 cm / 6 3/4"



J-33-370
 14 cm / 5 1/2"



J-33-380
 14 cm / 5 1/2"



Doyen
J-33-390
 13 cm / 5"
 24/30 mm
J-33-400
 16 cm / 6 1/4"
 30/34 mm.



Bruenings
J-33-410
 19 cm / 7 1/2"
 19/15 mm



Collin
J-33-420
 16.5 cm / 6 1/2"



Frenzel
J-33-430
 16.5 cm / 6 1/2"



Buchwald
J-33-440
 17 cm / 6 3/4"



J-33-442
 16 cm / 6 1/4"
 Wood
 Package of
 100 Pieces



J-33-444
 15 cm / 6"
 Acrylic glass
 Package of
 100 Pieces



J-33-446
 18.5 cm / 7 1/4"
 Nylon
 Package of
 100 Pieces

Oral Instruments

Lip and Cheek Retractors

Lippen- u. Wallgenhalter

Separadores para labios y mejillas



Sternberg

J-33-491 12 cm / 4 3/4"
J-33-492 14 cm / 5 1/2"
J-33-493 16 cm / 6 1/4"



Simplex

J-33-600
10.5 cm / 4"



J-33-610

14 cm / 5 1/2"
Vestibulum retractor

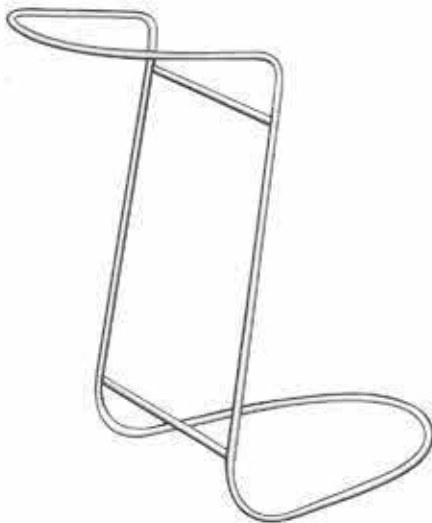

Obwegeser

J-33-620
12 cm / 4 3/4"



Bishop

J-33-494
13.5 cm / 5 1/4"
27 mm



Jaeger

J-33-1380 Stainless steel
J-33-1381 Plastic
10 cm / 4"
Lid plate



Crawford Minnesota
J-33-495
 16 cm / 6"
 20 mm



J-33-630
 14.5 cm / 5 3/4"
 Fenestrated



J-33-640	18 x 9.5 mm
J-33-641	28 x 12.5 mm
J-33-642	41 x 13.5 mm
J-33-643	53 x 13.5 mm

Converse
 9 cm / 3 1/2"



Lange
J-33-670
 23 cm / 9"
 Alar hooklet, button end

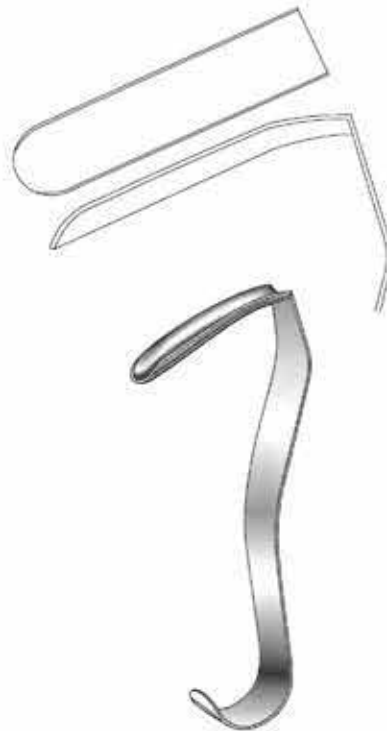

Converse
J-33-650
 10.5 cm / 4"
 44 x 11 mm blade



J-33-680	1.5 mm Ø
J-33-681	1.7 mm Ø
J-33-682	2.0 mm Ø
J-33-683	2.5 mm Ø
J-33-684	3.0 mm Ø



Siebenmann
 15 cm / 6"
 Antrum cannula

Oral Instruments

Tongue Depressors

Zungendrucker

Abajalenguas



Bosworth

J-33-450

14 cm / 5 1/2"



85 x 24 mm

Tobold

J-33-460

14 cm / 5 1/2"

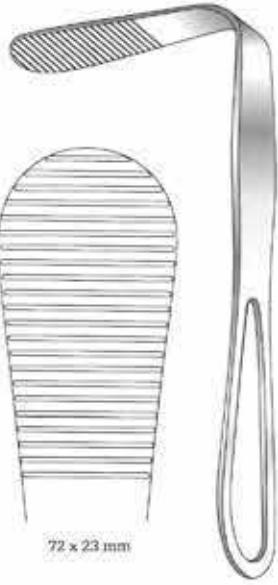

72 x 23 mm

Hartmann

J-33-462

15 cm / 6"

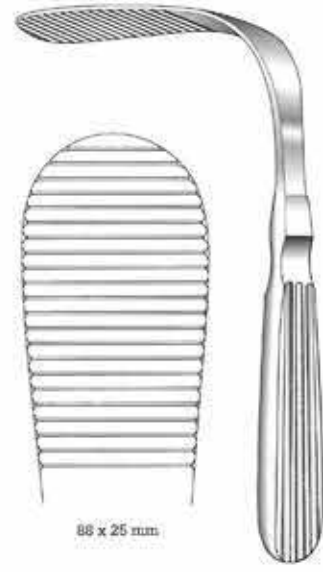

88 x 25 mm

Tobold

J-33-464

15 cm / 6"

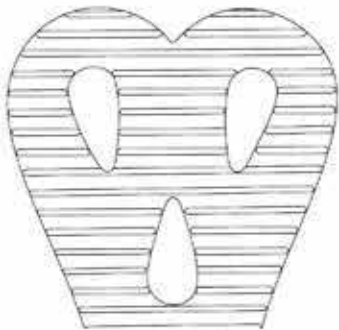

J-33-480

15 cm / 6"

43 mm



J-33-470

14 cm / 5 1/2"

36 mm

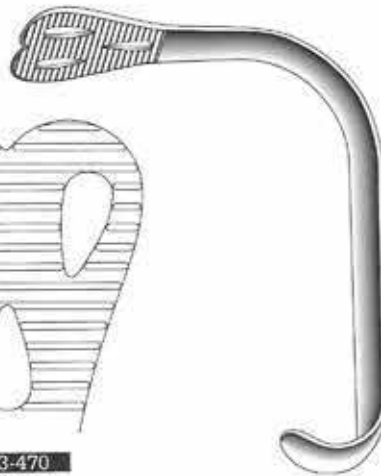

Wieder



Lack

J-33-490

10 cm / 4"



Collin
J-33-500
 16 cm / 6 1/4"



Collin
J-33-509 16 cm / 6 1/4"
J-33-510 17 cm / 6 3/4"
J-33-520 19 cm / 7 1/2"



Guy
J-33-530
 19 cm / 7 1/2"

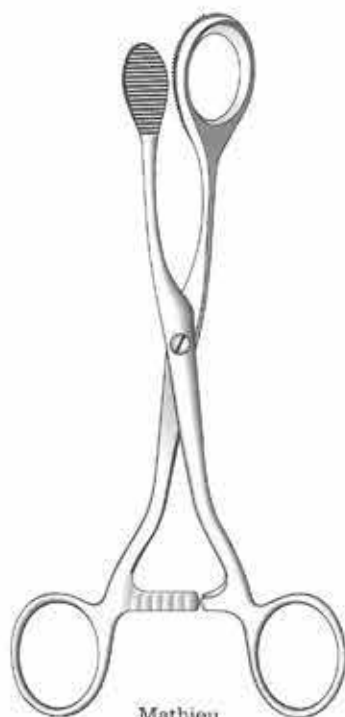

Mathieu
J-33-540
 19 cm / 7 1/2"



Young
J-33-650
 17 cm / 6 3/4"



J-33-560
 23 x 15 mm
 Pair
 Rubber inserts

Oral Maxillo-Facial Surgery

Chin, Channel & Ramus Retractors

Kinnhalter, Progenierinnen und Ramushaken

Gancho de menton, Separadores mandibulares Y de Rama



Terry
J-33-810
16.5 cm / 6 1/2"



Obwegeser
J-33-820 8 mm
J-33-821 10 mm
17 cm / 6 3/4"



J-33-830
8 mm

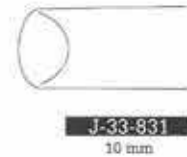

J-33-831
10 mm



Obwegeser
J-33-840
16.5 cm / 6 1/2"

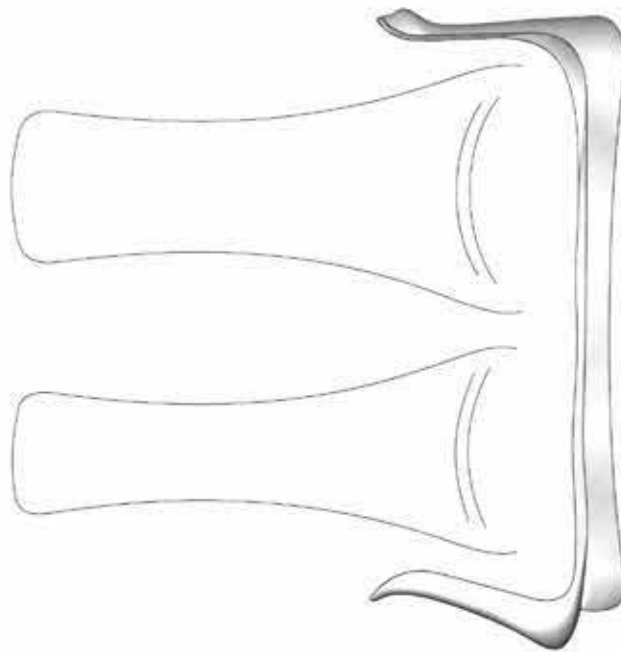

Hargis
J-33-850
16 cm / 6 1/4"
Lip and cheek retractors



Obwegeser
J-33-700
16 cm / 6 1/2"
16.5 mm
Chin holder



J-33-870
 20 x 12; 30 x 16 mm

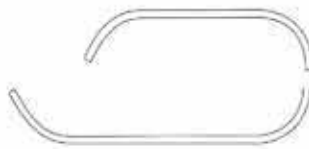

J-33-872
 30 x 12; 35 x 16 mm



J-33-860
 20 x 7; 30 x 10 mm



J-33-874
 35 x 12; 45 x 16 mm



J-33-880
 50 x 12; 70 x 16 mm



Tessier
 15 cm / 6"
 Black chromium plated



Tessier
 15.5 cm / 6"
 Black chromium plated



Tessier
 15.5 cm / 6"
 Black chromium plated

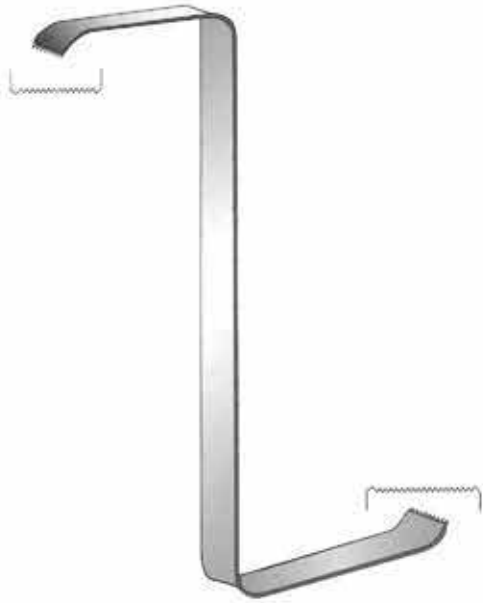

Tessier
16 cm / 6 1/8"
Black chromium plated



J-33-890
30 x 12; 35 x 16 mm



J-33-892
35 x 12; 45 x 16 mm



J-33-894
50 x 12; 70 x 16 mm



J-33-900
7 mm
Fig. 1



J-33-902
8 mm
Fig. 2



J-33-904
10 mm
Fig. 3

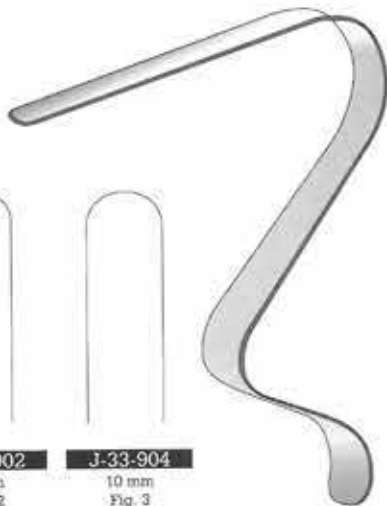

Tessier
12.5 cm / 5"
Black chromium plated

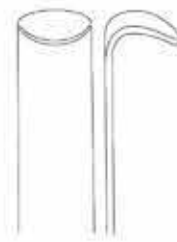

J-33-910
10 mm
Fig. 4



J-33-911
8 mm
Fig. 5



J-33-912
12 mm
Fig. 6



Tessier
12.5 cm / 5"
Black chromium plated



Obwegeser
 24 cm / 9½"
 Bent downwards



Obwegeser
 24 cm / 9½"
 Bent upwards

Crano Maxillo-Facial Surgery

Third Molar and Soft Tissue Retractors

Weisheitszahn Haken und Weichteilhaken

Separador para muela del juicio Y para partes blancas

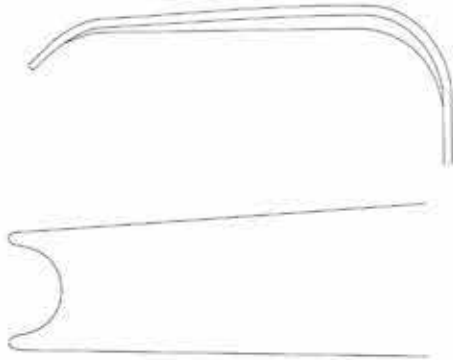

Obwegeser
J-33-930
15/22 x 70 mm
24 cm / 9 1/2"
Third molar retractor

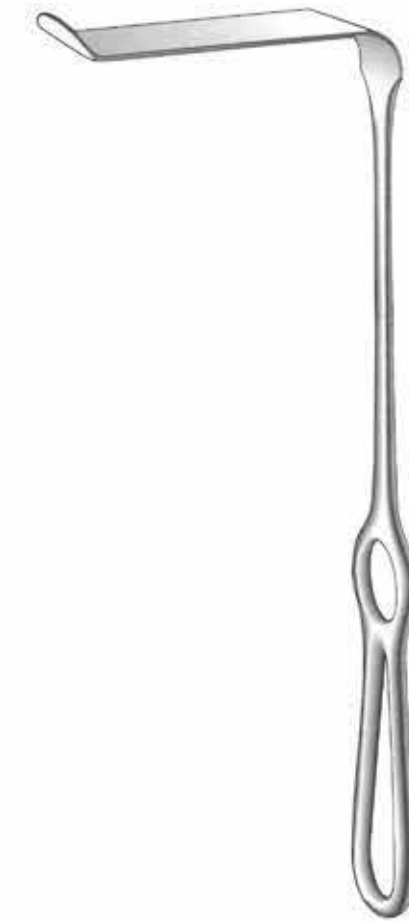
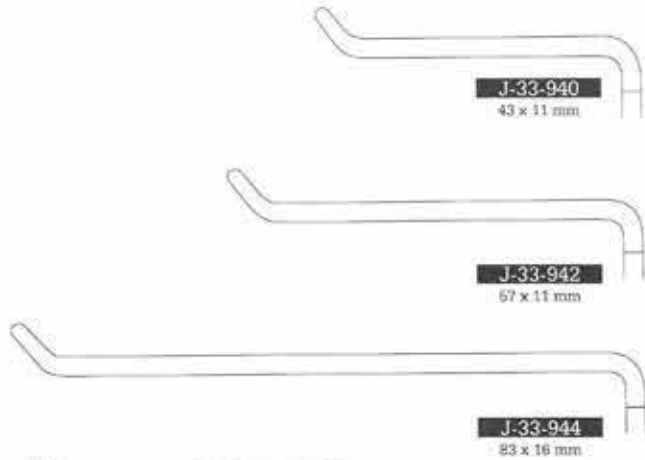

Obwegeser
21.5 cm / 8 1/2"

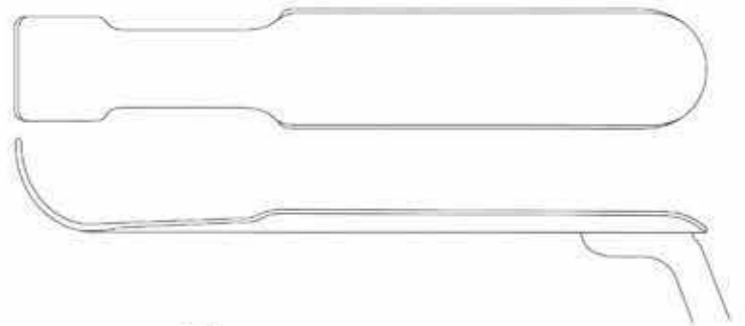
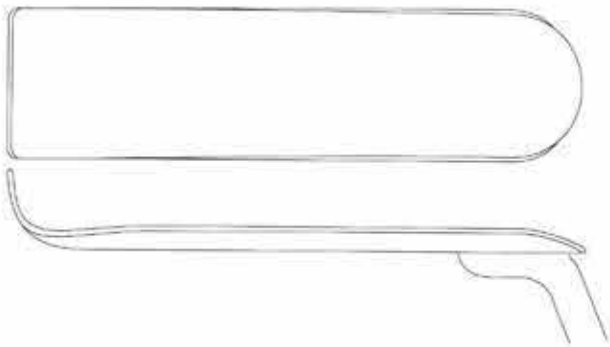

Schuchardt
J-33-960
15 cm / 6"



Metz
J-33-970
15 cm / 6"

Oral Maxillo-Facial Surgery

Ramus Retractors

Ramushaken

Separadores para el ramo

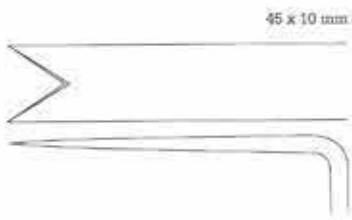

Obwegesser
J-33-980
22 cm / 8 1/2"
Nasal spine retractor

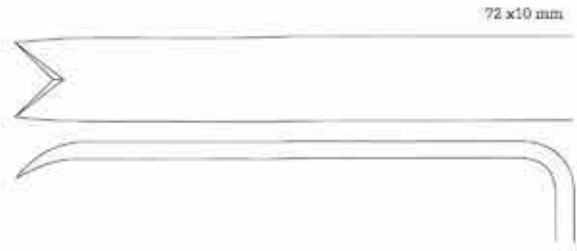

Obwegesser
J-33-990
22 cm / 8 1/2"



J-33-1000
11/15 x 70 mm

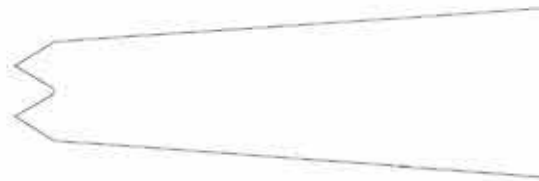

J-33-1002
12/22 x 70 mm



Obwegeser
24.5 cm / 9 7/8"

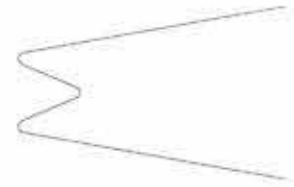

Obwegeser
J-33-1010
 24.5 cm / 9 7/8"
 10/23 x 40 mm
 Nasal spine retractor



J-33-1020
9/12 x 30 mm



J-33-1022
9/12 x 45 mm



J-33-1024
9/12 x 60 mm



J-33-1030
Left



J-33-1032
Right



Obwegeser
21 cm / 8 1/4"



Steinhauser
23 cm / 9"
20 x 150 mm

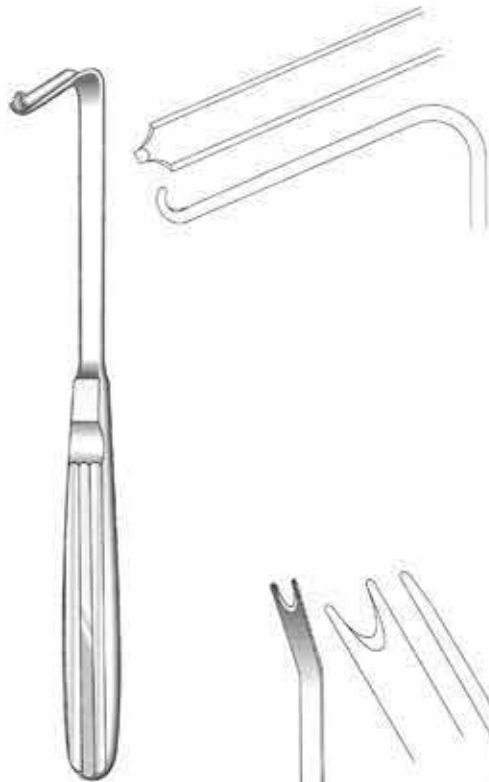

Hargis
J-33-1040
 18.5 cm / 7 1/4"



Hargis
 19.5 cm / 7 3/4"

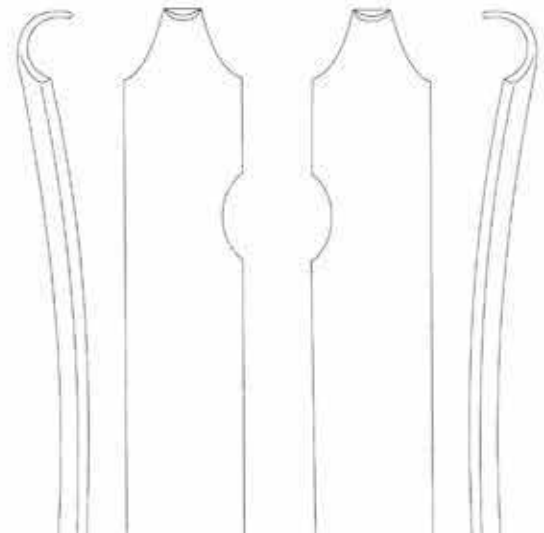

J-33-1050
 Right

J-33-1052
 Left



Terry
J-33-1060
 24 cm / 9 3/8"
 Ramus pusher



Obwegeser
J-33-1070
 18 cm / 7"
 10 mm
 Angled to left



Obwegeser
J-33-1080
 18 cm / 7"
 10 mm
 Angled to right

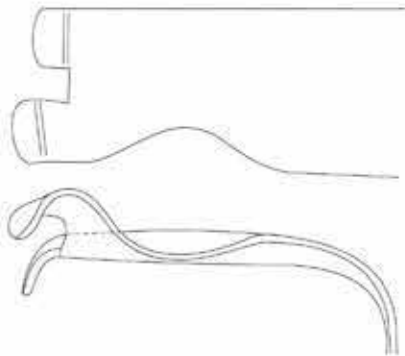

J-33-1090
Left

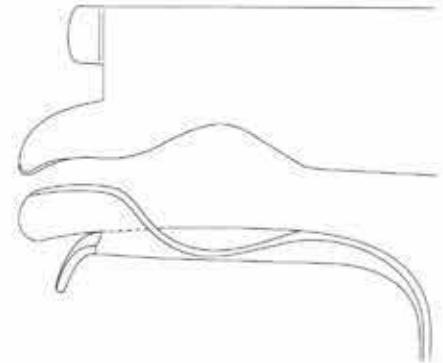

J-33-1100
Left



Arnhem
22 cm / 8 3/4"
LeFort I retractor

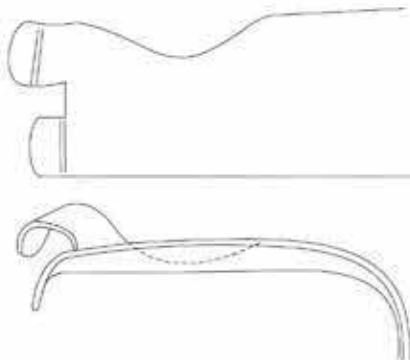

J-33-1092
Right

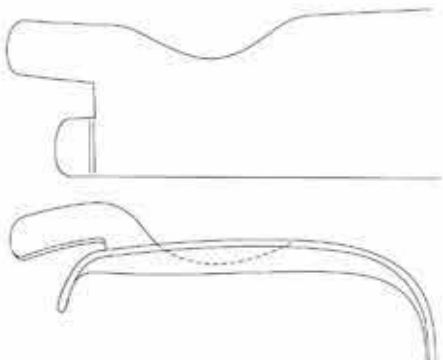

J-33-1102
Right



Arnhem
22 cm / 8 3/4"
Sinus lift retractor

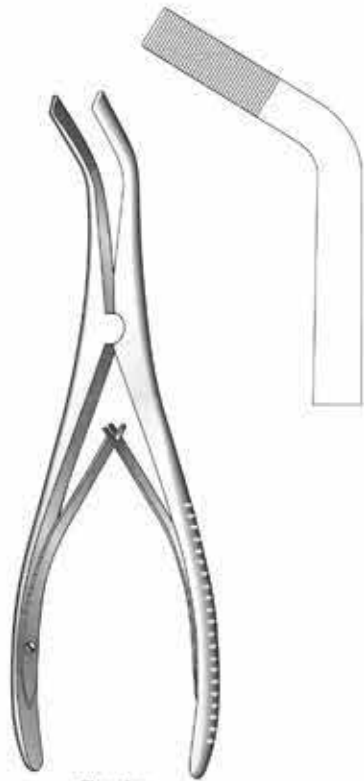

Tessier
J-33-1110
 17.5 cm / 7"
 7mm
 Spreading forceps



Turvey
J-33-1420
 17 cm / 6 3/4"
 Palatal expander

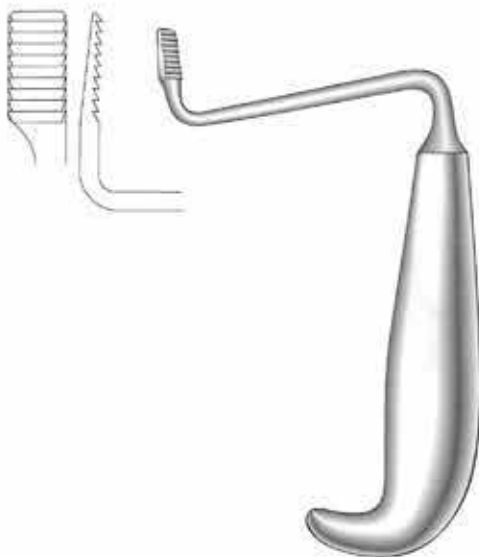

Tessier
J-33-1120
 15 cm / 6"
 9 mm
 Right

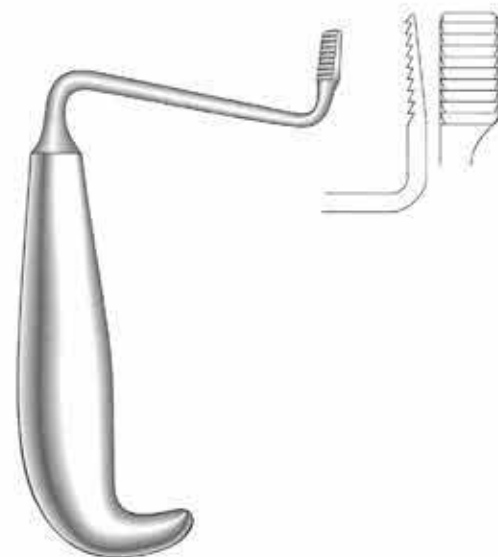

Tessier
J-33-1130
 15 cm / 6"
 9 mm
 Left

Crano Maxillo-Facial Surgery

Mandibular Body Retractor, Anterior Border Stripper, Sagittal Split Separators

Unterkieferkorperhaken, Vorderrandstripper, Sagittalspreizer

Separador para el cuerpo mandibular Y el horde anteriore, para Sagitales



Hargis
J-33-1140
18 cm / 7"



Dingmann Wilk
J-33-1150
20 cm / 8"



Hargis
J-33-1160
19 cm / 7 1/2"



Steinhauser
J-33-1170
27 cm / 10 1/2"
Extra long channel retractor



J-33-1400
Right

Smith
18.5 cm / 7 1/4"
9 mm



J-33-1405
Left

Smith
18.5 cm / 7 1/4"
9 mm

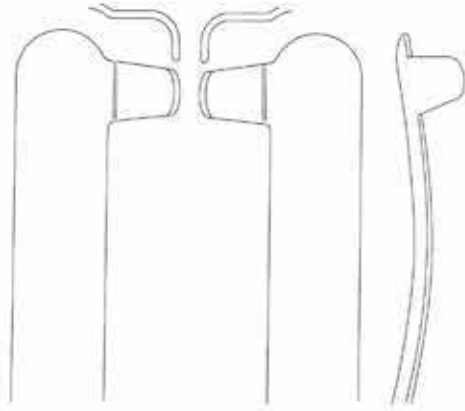

J-33-1180
 21 cm / 8 1/4"
 26.5 / 16 mm
 Right



J-33-1190
 21 cm / 8 1/4"
 26.5 / 16 mm
 Left



J-33-1200
 25 cm / 9 1/4"
 12.5 / 27 mm
 L&M. for vertical osteotomy



J-33-1210
 22 cm / 8 3/4"
 9.5 / 16 mm
 Concave blade, fully bent tip
 Extra oral retractor



J-33-1220
 23 cm / 9"
 25.5 mm
 For LeFort osteotomies

Crano Maxillo-Facial Surgery

Intra Oral Retractors

Intraorale Retraktoren

Separadores intra. orales

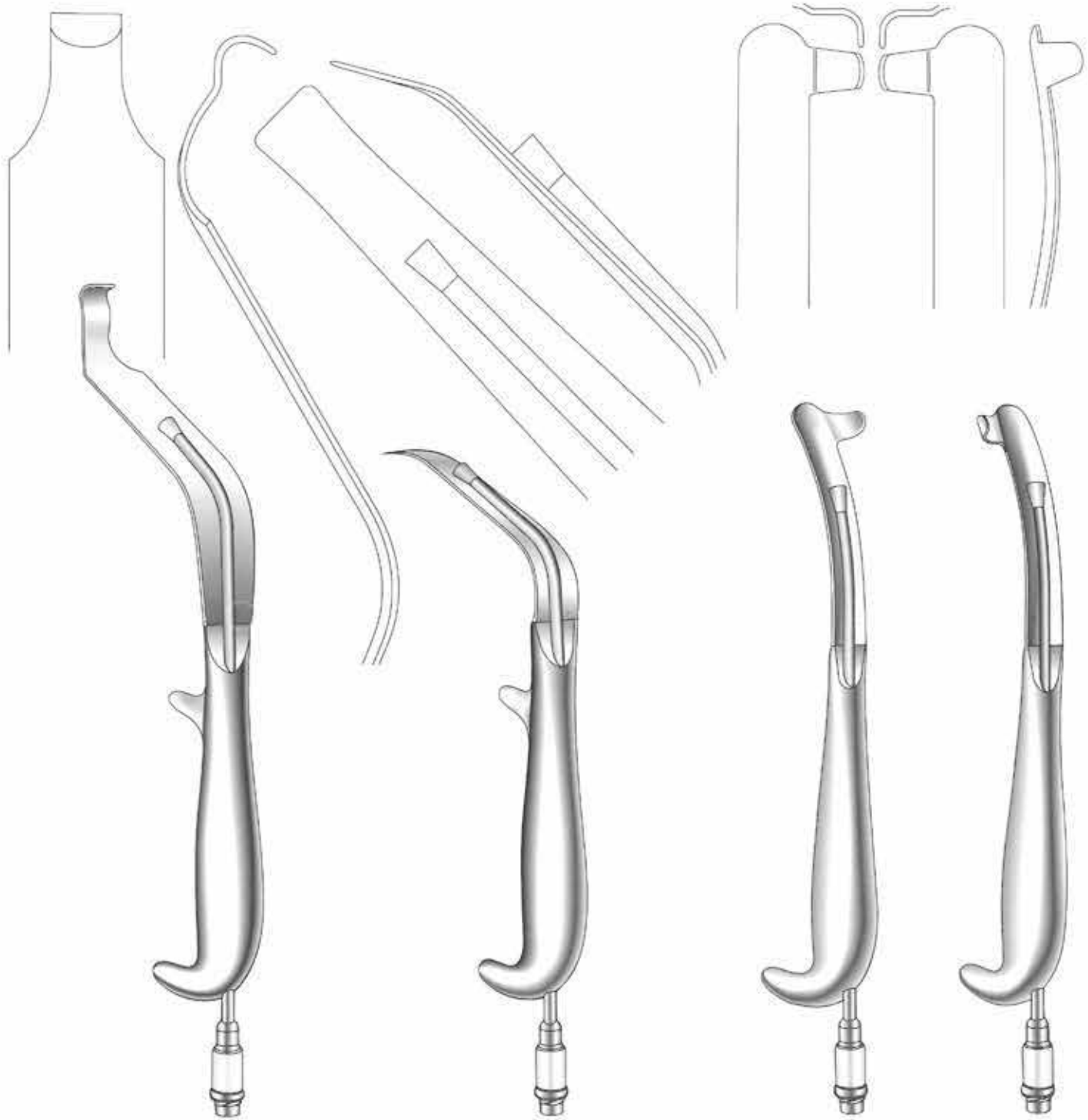

J-33-1230
28 cm / 11"
12.5 / 27 mm
L&M, for vertical osteotomy
with fiber optic light carrier

Shea
J-33-1240
22 cm / 8 3/4"
14.5 mm
Multi purpose retractor
with fiber optic light carrier

J-33-1250
24.5 cm / 9 3/4"
26.5 / 16 mm
Right
with fiber optic light carrier

J-33-1260
24.5 cm / 9 3/4"
26.5 / 16 mm
Left
with fiber optic light carrier

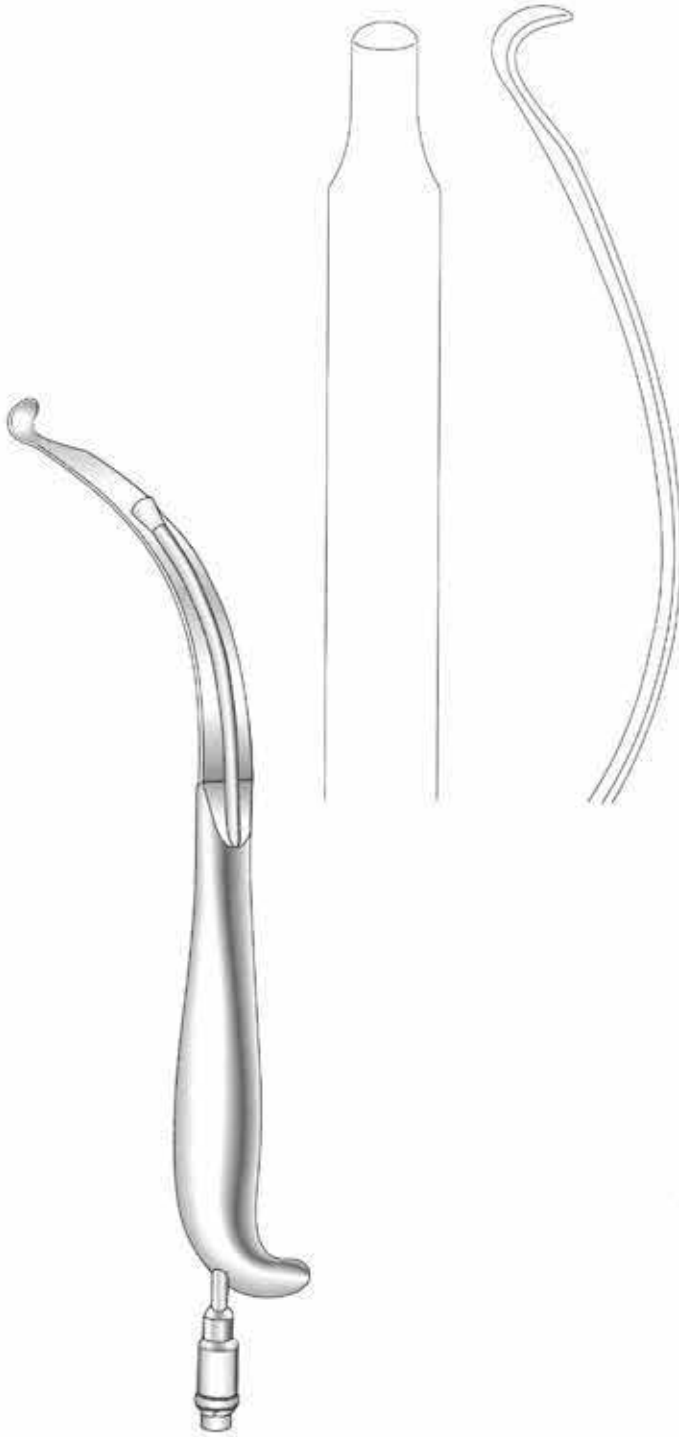

J-33-1270
25.5 cm / 10"
9.5 / 16 mm
Concave blade, fully bent tip
Extra oral retractor
with fiber optic light carrier

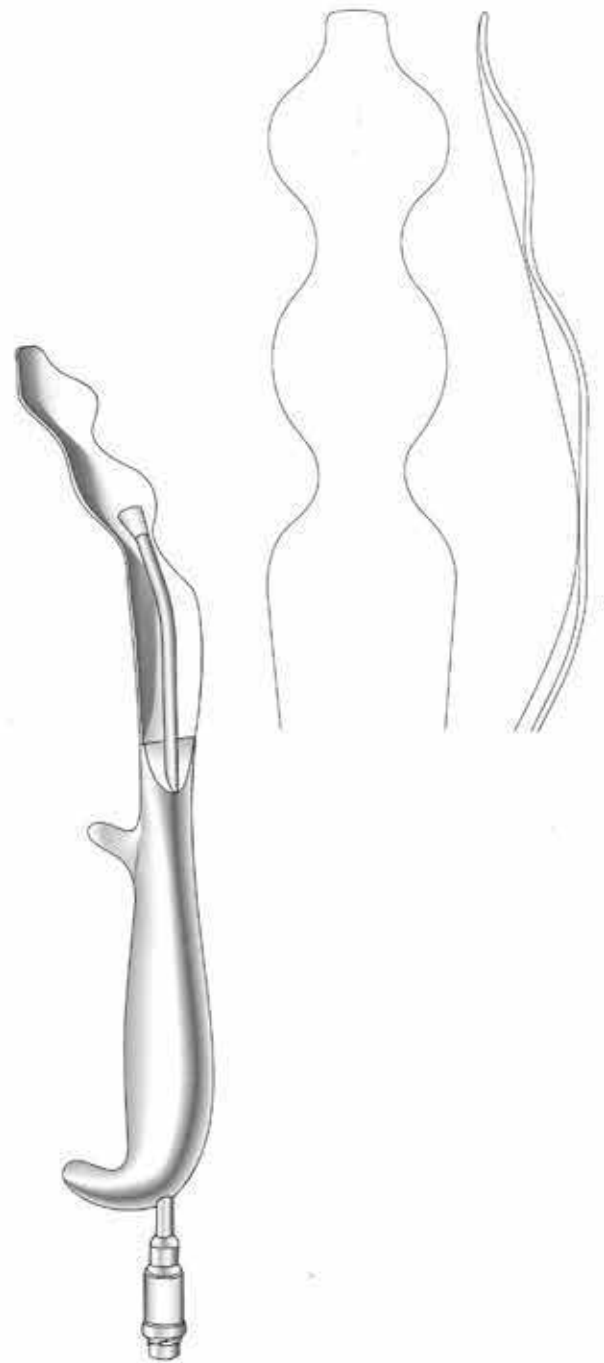

J-33-1280
27 cm / 10 3/4"
25.5 mm
For LeFort osteotomies
Intra oral retractor
with fiber optic light carrier

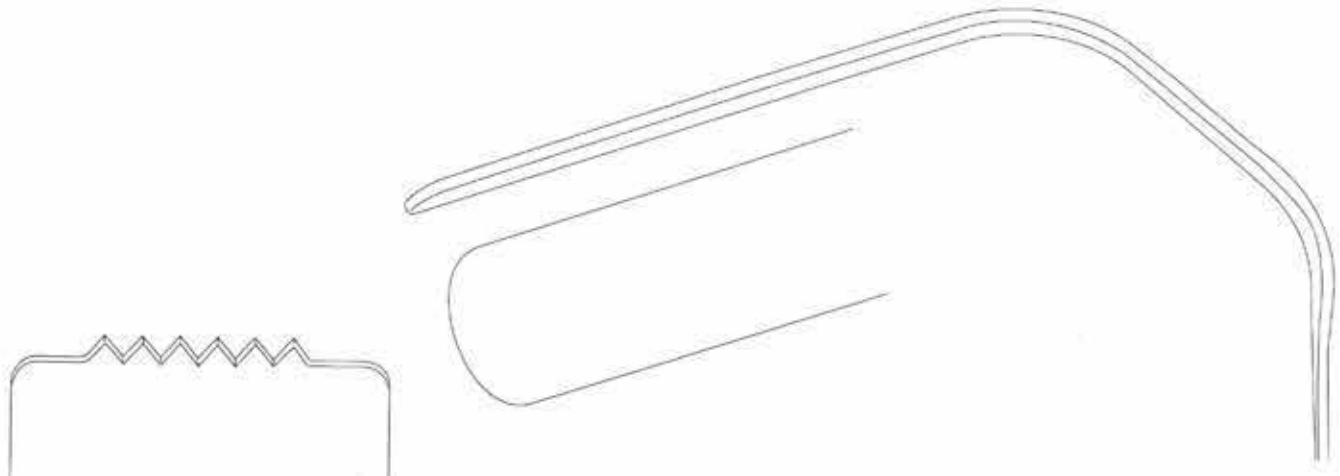

- J-33-1290** 36 x 50 mm
- J-33-1292** 52 x 50 mm
- J-33-1294** 59 x 50 mm
- J-33-1296** 66 x 50 mm



Tessier
 16 cm / 6 1/4"
 Black chromium plated



Tessier
J-33-1300 90 x 22 mm
J-33-1302 120 x 28 mm
 20.5 cm / 8"
 Black chromium plated



Hurd
J-34-001
 21 cm / 8 1/4"
 For right hand



Hurd
J-34-005
 21 cm / 8 1/4"
 For left hand



Durham
J-34-020
 25 cm / 10"



Durham
J-34-030
 25 cm / 10"



Dupuy-Weiss
J-34-040
 22 cm / 8 3/4"



Dupuy-Weiss
J-34-050
 22 cm / 8 3/4"



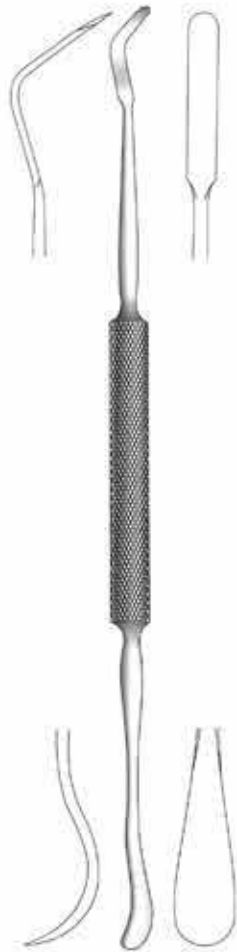

Carpenter
J-34-140
 22.5 cm / 9"
 4.4/8.8 mm

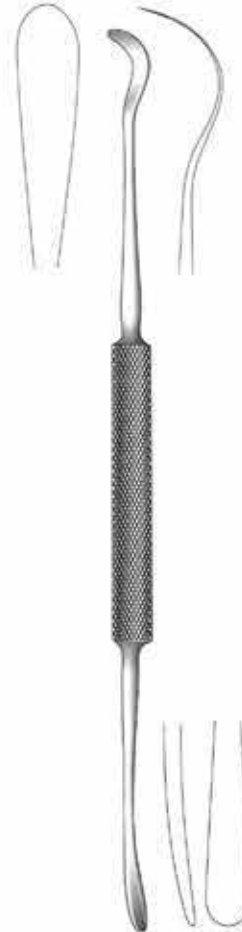

Carpenter
J-34-150
 22.5 cm / 9"
 4.4/8.8 mm

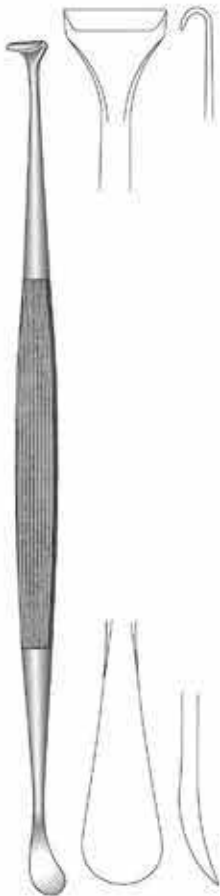

Hurd
J-34-151
 23 cm / 9"
 11/14 mm



Henke
J-34-152
 23 cm / 9"
 10.5/5 mm



Henke
J-34-153
 23 cm / 9"
 16/5 mm

Tonsil

Dissectors, Retractors, Gauze Packers
Dissektoren, Wundhaken, Tamponstopfer
Disecadores, Separadore, Taponeadores



Nager
J-34-154
24 cm / 9½"

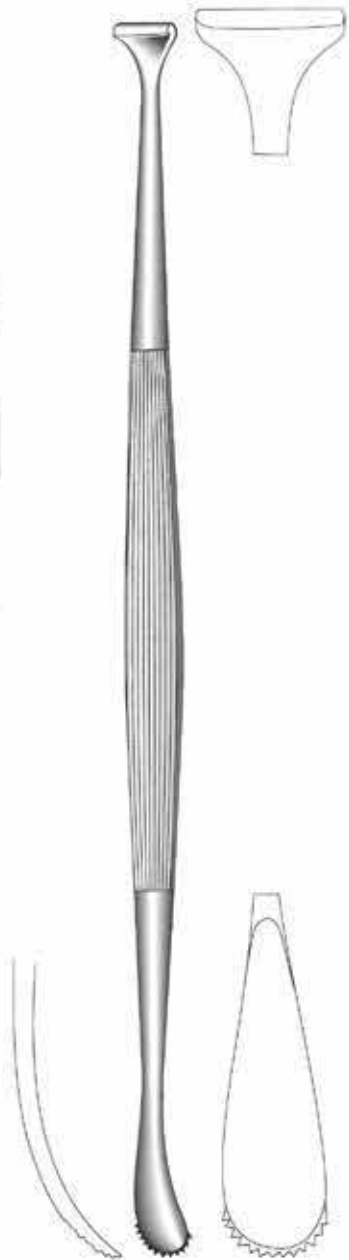

Hurd
J-34-156
22 cm / 8¾"
10 x 12 mm wide
Throat retractors and dissector

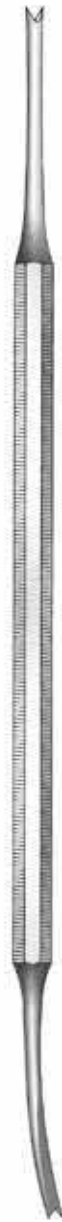

Luniatschek
17.5 cm / 7"

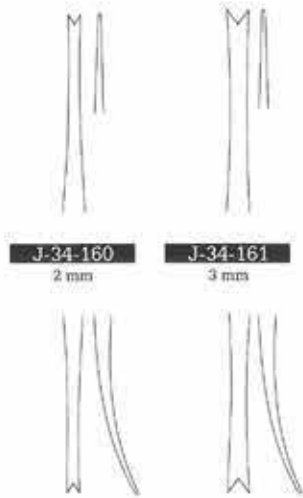

J-34-160
2 mm

J-34-161
3 mm



Luniatschek
17.5 cm / 7"



J-34-165
2 mm
Round handle

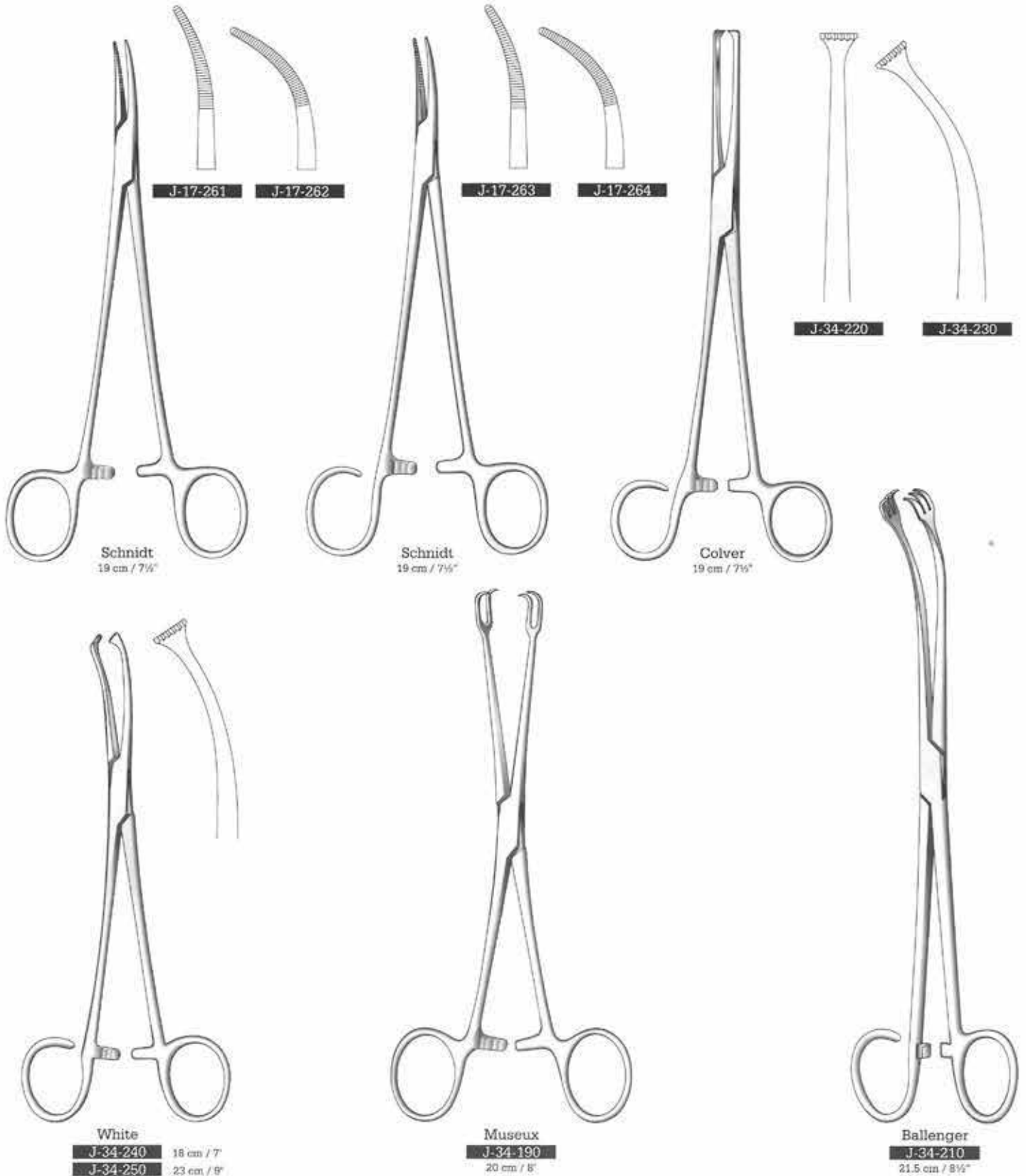

Tonsil

Tonsil Seizing Forceps

Tonsillenzangen

Pinzas para coger las amígdalas

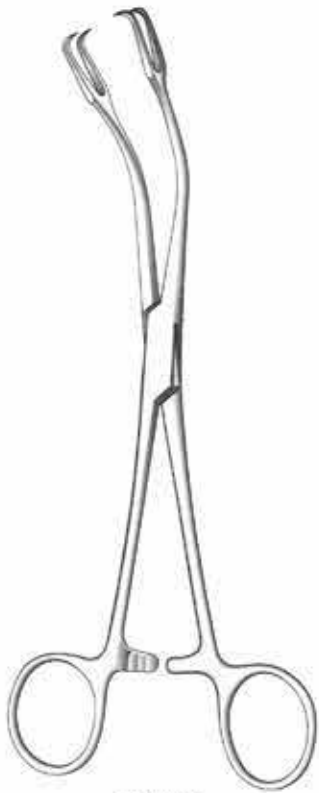

Museux
J-34-200
20 cm / 8"



Tivnen-Tyding
21 cm / 8 1/4"



J-34-180

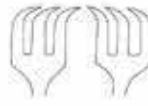

J-34-182

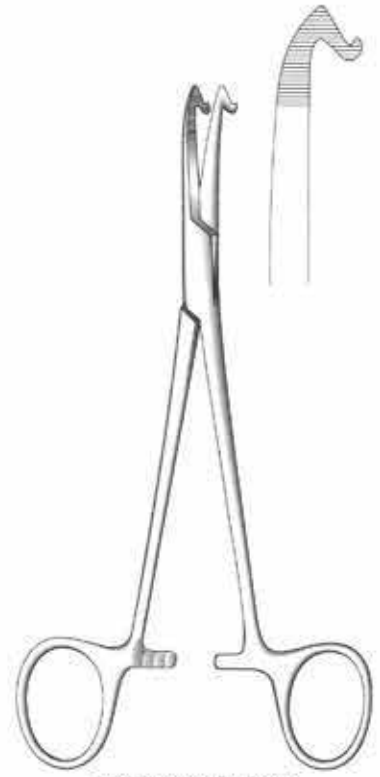

McWhorter-Lothrop
J-34-300
18 cm / 7"



Blohmke
J-34-290
20 cm / 8"

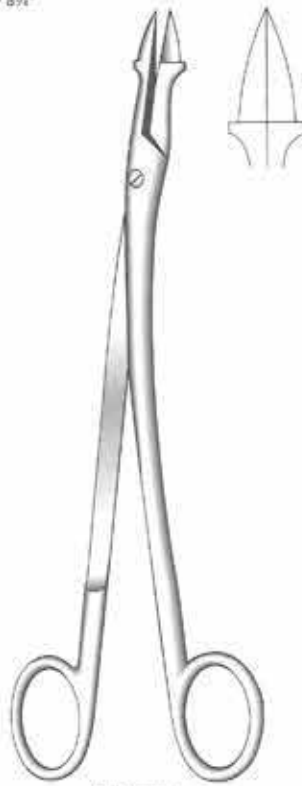

Thilenius
J-34-280
20 cm / 8"

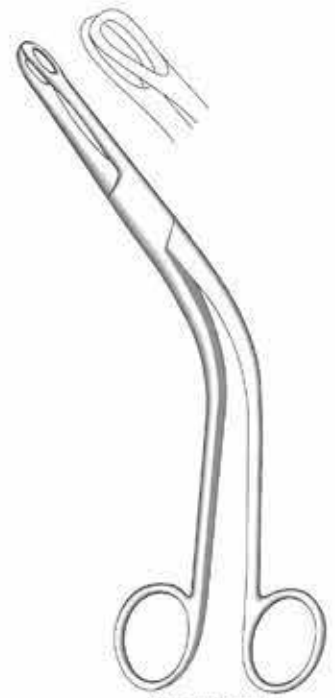

Denis-Browne
J-34-310
18 cm / 7"



J-34-311
0.3 mm \varnothing



Eves
J-34-312
28 cm / 11"



Eves
J-34-313
28 cm / 11"



Bruenings
J-34-314
28 cm / 11"

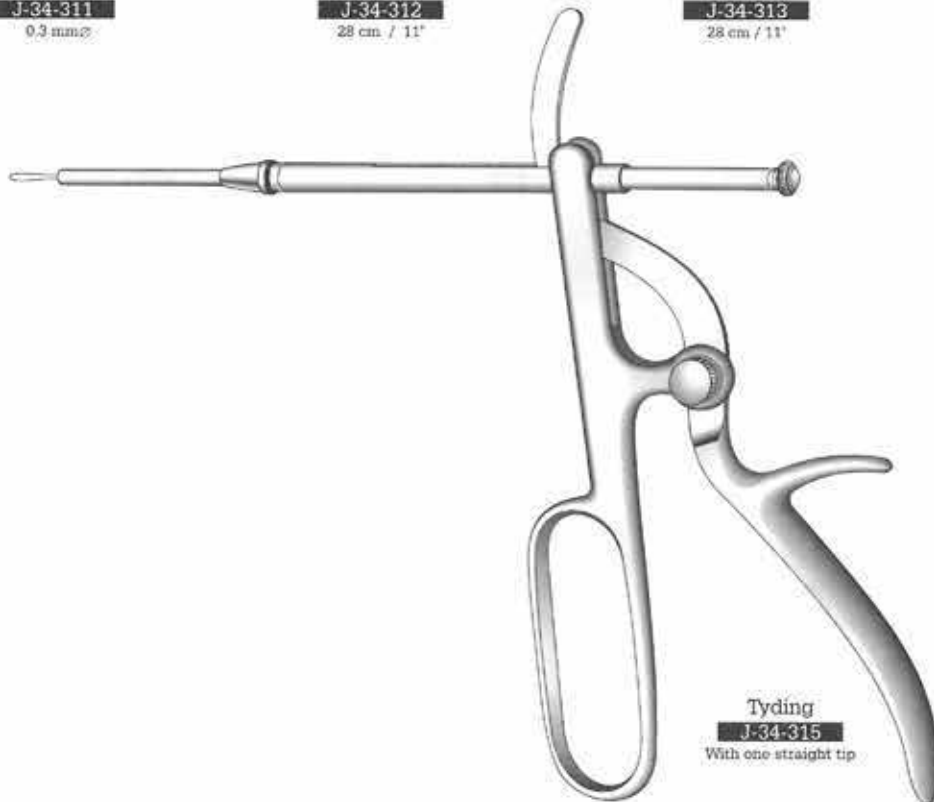

Tyding
J-34-315
With one straight tip

