





ORTHOPEDIC



 www.convertualinterlogic.com

 +234 8033200998
+234 8180003461

 enquiries@convertualinterlogic.com

 1 Anu Crescent, Off Ado-Badore Road,
Ajah, Lagos, Nigeria



Esmarch
JO-21-100
18 cm / 7"



Reiner
JO-21-101
18.5 cm / 7 1/4"



Hopkins
JO-21-102
20 cm / 8"



Mod. Surgicon
JO-21-103
21 cm / 8 1/4"

For more bandage scissors, also see page 69



Smith
(Mod. USA)
JO-21-127
20 cm / 8"

Bruns
JO-21-132
23.5 cm / 9 1/4"
18 Gold
JP-22-718
24 cm / 9 1/2"
Open shanks with pin

Bruns
JO-21-133
23.5 cm / 9 1/4"
Closed shanks, serrated

Bruns
JO-21-2334
24 cm / 9 1/2"
Open shanks with pin, serrated

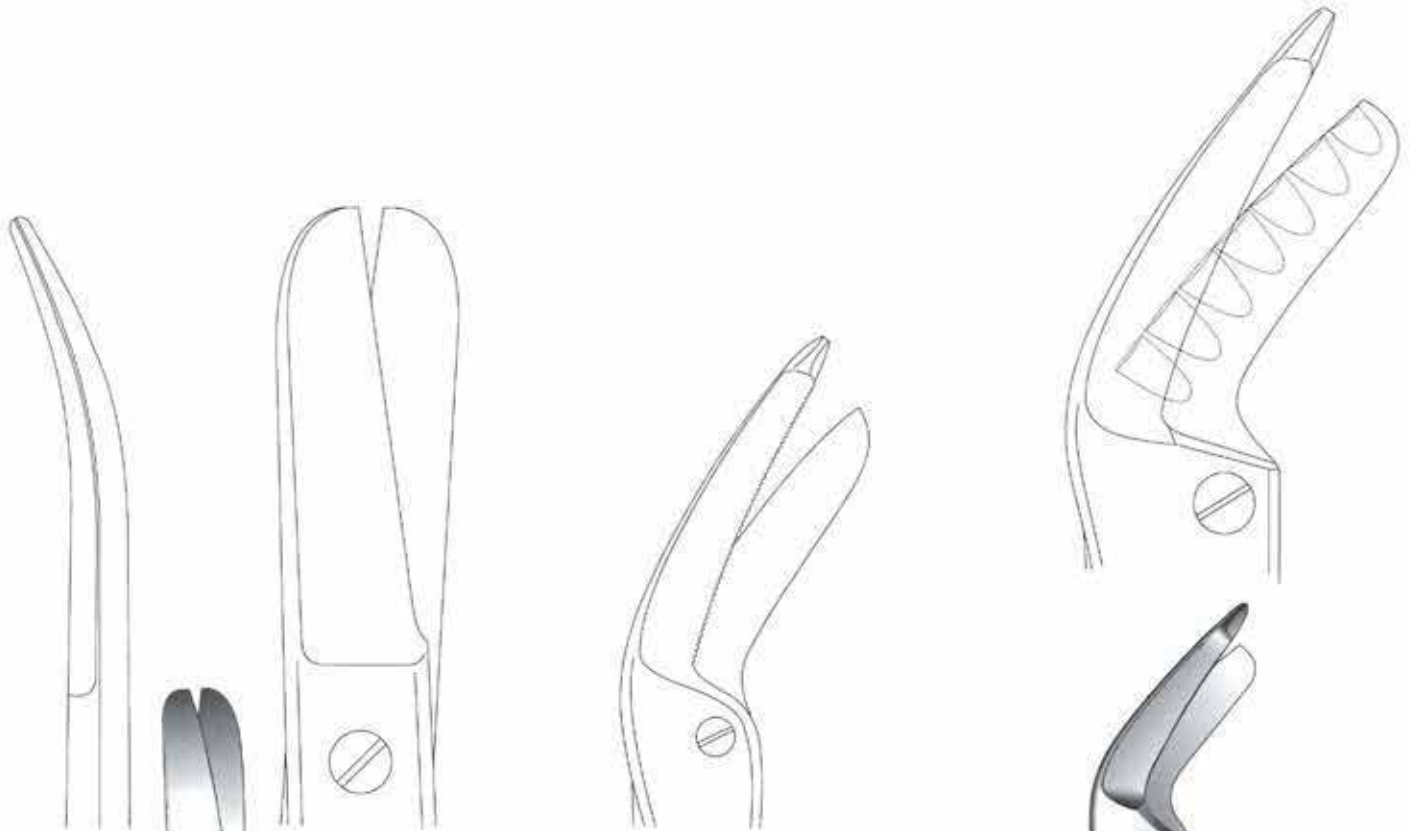

Lorenz
JO-21-128
23 cm / 9"



Excentric
JO-21-129 16 cm / 6 1/4"
JO-21-130 16 cm / 7 1/4"



Tornado
JO-21-131
24 cm / 9 1/2"
Undulated cutting edge



Seutin
JO-21-134
23 cm / 9"



Tessier
JO-21-1500
19.5 cm / 7 3/4"
1 serrated cutting edge

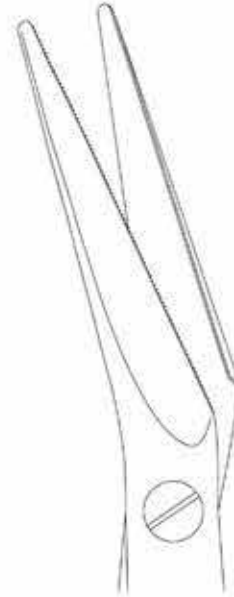

Tessier
JO-21-1505
19 cm / 7 1/2"
1 serrated cutting edge



Universal
JO-21-149
20 cm / 8"

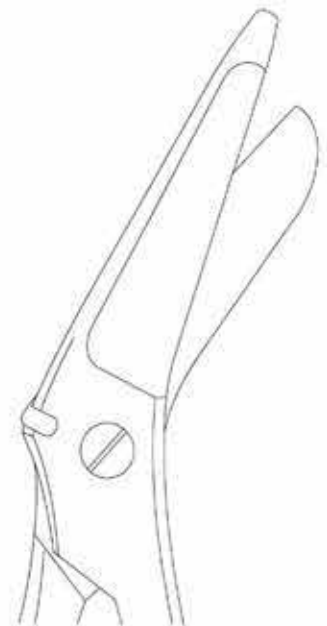

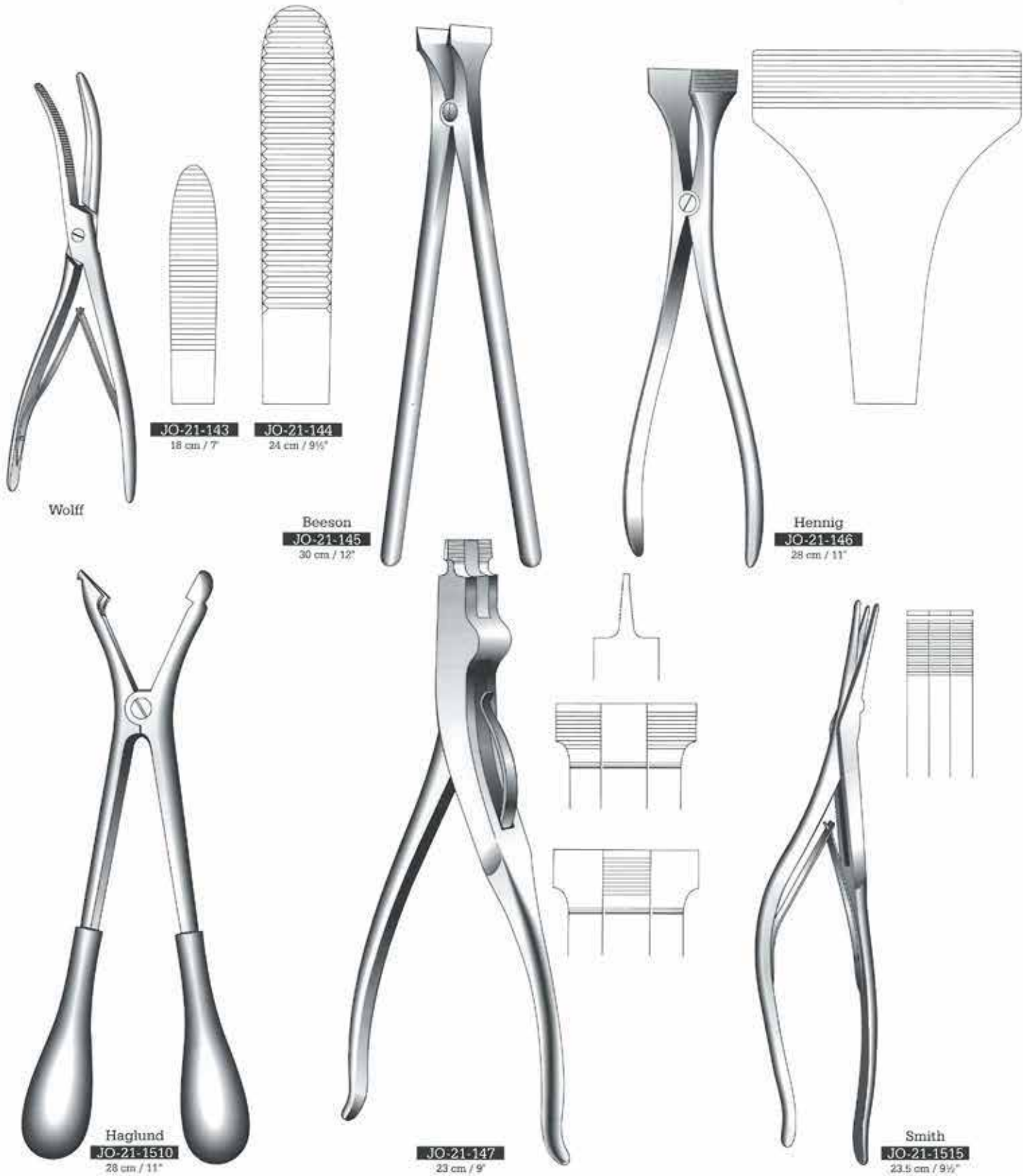

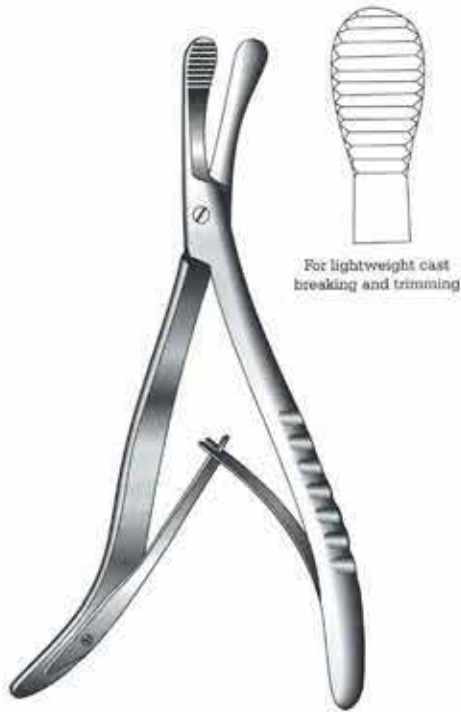

For lightweight cast
breaking and trimming

Masson
JO-21-148
18 cm / 7"
Pediatric cast breaker
deep serrated tips



Stille
JO-21-151
24 cm / 9½"



Stille-Mini
JO-21-2200
Blade with reinforced back
JO-21-2201
Blade without reinforced back
20 cm / 8"



Stille

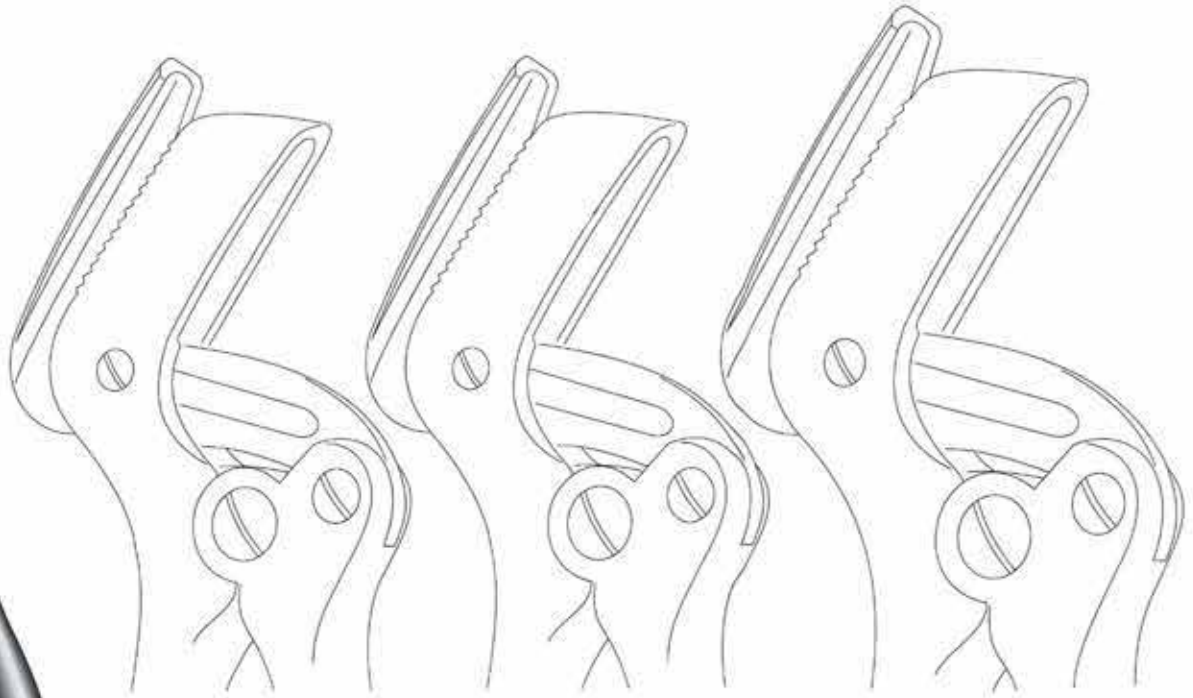

JO-21-153
Blade with reinforced back
JO-21-2202
Blade without reinforced back
23 cm / 9"

JO-21-154
Blade with reinforced back
JO-21-2203
Blade without reinforced back
26 cm / 10¼"

JO-21-155
Blade with reinforced back
JO-21-2204
Blade without reinforced back
37 cm / 14½"



JO-21-156
16.5 cm / 6½"
140 gm / 5 oz, 20 mm Ø



Collin
JO-21-157
20 cm / 8"
220 gm / 7¾ oz, 30 mm Ø

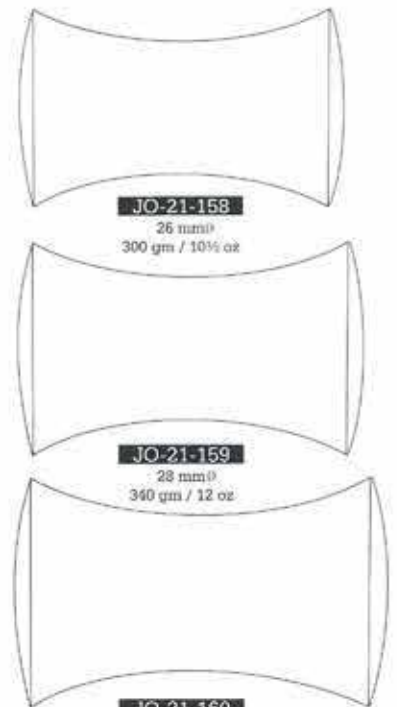

JO-21-158
26 mm Ø
300 gm / 10½ oz

JO-21-159
28 mm Ø
340 gm / 12 oz

JO-21-160
30 mm Ø
400 gm / 14 oz



Lucae
19 cm / 7½"



JO-21-161
19 mm Ø
230 gm / 8 oz

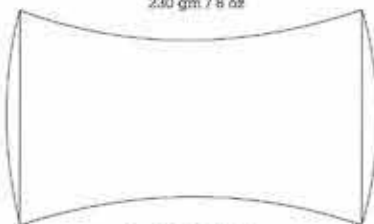

JO-21-162
25 mm Ø
260 gm / 9 oz



Doyen
21 cm / 8¼"

Williger
24 cm / 9½"



JO-21-163
25 mm Ø
120 gm / 4¼ oz

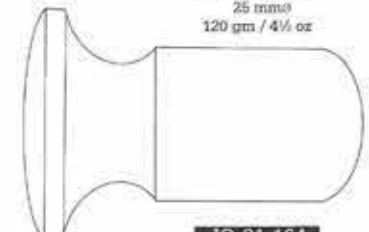

JO-21-164
30 mm Ø
180 gm / 6½ oz



JO-21-165
35 mm Ø
260 gm / 9 oz



Mead
320 gm, 26 mm \varnothing
JO-21-166
Solid
JO-21-167
17 cm / 6 3/4"
Ferrocell faces only, pair



Partsch
22 mm \varnothing
JO-21-168
18 cm / 7"
200 gm
JO-21-1520
16 cm / 6 1/4"
165 gm
JO-21-1521
18 cm / 7"
220 gm



Heath
JO-21-169
18.5 cm / 7 1/2"
700 gm, 40 mm \varnothing
Cooper filled head



Autoclavable to
250°F (121°C)

Mallet Lightweight
19 cm / 7 1/2"
25 mm \varnothing
JO-21-1525
140 gm
JO-21-170
Two replaceable nylon caps
Total weight: 7 oz.
Head weight: 4 oz.



Autoclavable to
250°F (121°C)

Combination Mallet
19 cm / 7 1/2"
JO-21-171
Total weight: 9 oz
Head weight: 5 oz.
26 mm \varnothing
JO-21-172
Total weight: 12 oz
Head weight: 8 oz
38 mm \varnothing
One side nylon cap



JO-21-1530
1000 gm
JO-21-1531
700 gm
JO-21-1532
500 gm



Aluminum handle
JO-21-1540
350 gm, 11 oz
JO-21-1545
500 gm, 22 oz
Heavy



Cottle
JO-21-1560
19 cm / 7 1/2"
240 gm, 30 mm \varnothing



Gerzog
JO-21-1550
18 cm / 7"
250 gm



Kirk
JO-21-1555
19 cm / 7½"
750 gm



Ombredanne
JO-21-1565
24 cm / 9½"
550 gm, 40 mm Ø



Bergmann
JO-21-1570
24.5 cm / 9¾"
300 gm, 45 mm Ø



Bergmann
JO-21-1575
23.5 cm / 9¼"
300 gm, 30 mm Ø



Wagner
JO-21-1580
23.5 cm / 9¼"
35 mm Ø



Metal head
JO-21-1581
230 gm, 35 mm Ø



Plastic head
JO-21-1582
32 gm, 35 mm Ø



Quisling
JO-21-1585



JO-21-1590
23.5 cm / 9¼"



JO-21-173 450 gm
JO-21-176 900 gm
26 cm / 10 1/2"



JO-21-175
26 cm / 10 1/4"
510 gm / 18 oz
30 mm ø



JO-21-2210
Head weight 550 gm
Total weight 750 gm
40 mm ø



JO-21-2215
Head weight 350 gm
Total weight 550 gm
35 mm ø



JO-21-2220
Head weight 300 gm
30 mm ø



JO-21-2225
Head weight 300 gm
Total weight 500 gm
30 mm ø



JO-21-2230
Medium size hammer
Full aluminum
Total weight 200 gm



JO-21-2235
Small hammer aluminum handle
with stainless steel head
with rubber side (changeable)
Total weight 125 gm



15.5 cm / 6"

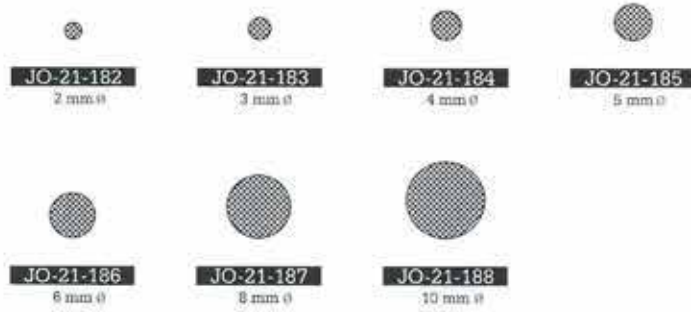

Kienny
JO-21-1150
17.5 cm / 7"



Trillat
JO-21-1151 9 x 9 mm
JO-21-1152 9 x 19 mm
20 cm / 8"



Cylindriques Double
JO 21-1153 8 x 15 mm Ø
16 cm / 6 1/4"
JO-21-1154 6 x 8 mm Ø
JO-21-1155 10 x 12 mm Ø
21 cm / 8 1/4"



JO-21-177
28 cm / 11"

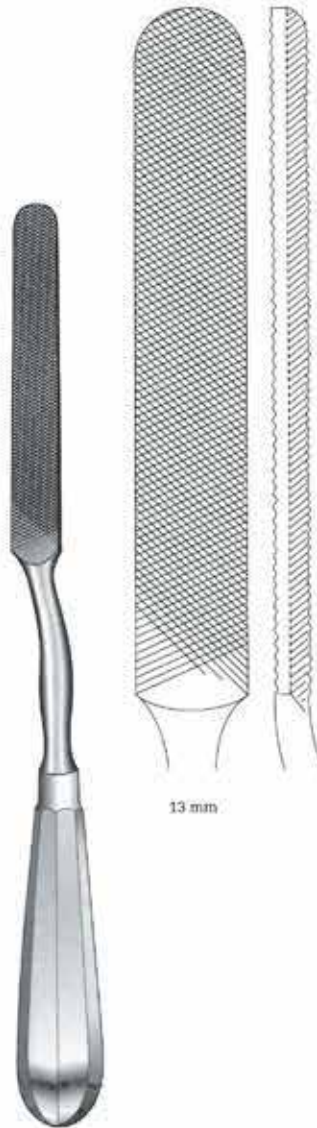

JO-21-178
24.5 cm / 9 1/2"



JO-21-179
22 cm / 8 3/4"



Putti
JO-21-180
 30 cm / 12"



Putti
JO-21-181
 27 cm / 10 1/2"



Fomon
JO-21-189
 21 cm / 8 1/4"
 Double ended, fine and coarse teeth 4-side, convex and flat blades 8 mm width

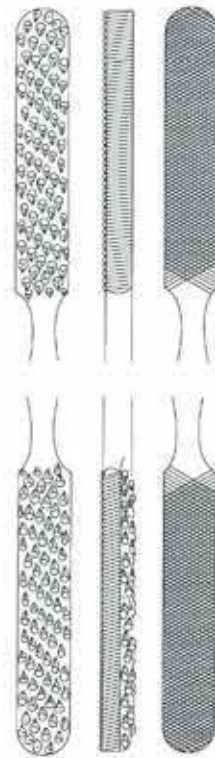

Murphy-Lane
JO-21-2170
 30 cm / 12"
 Bone skid

Orthopedic

Nasal Rasp, Bone Files

Nasenraspeln, Knochenfeile

Escofinasnasanes, Lima Para Huesos

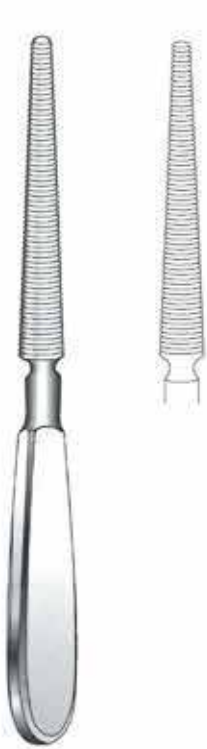

Trochlear
JO-21-1136
17 cm / 6 1/2"
Stainless steel



Maltz Improved
JO-21-190
21 cm / 8 1/4"
Double ended, forward and backward cutting, 8 mm width



Aufrecht
21 cm / 8 1/4"



JO-21-191
Single ended forward cutting
8 mm width



JO-21-192
Single ended backward cutting
8 mm width



Maltz
18 cm / 7"
Single ended
10 mm width

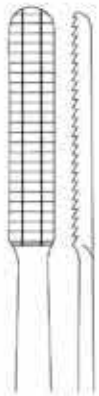

JO-21-193
34 x 7 mm
Backward cutting

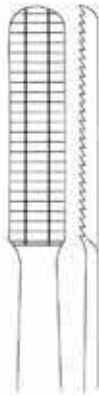

JO-21-1541
34 x 7 mm
Forward cutting



Excision Arthroplasty
JO-21-1137
17 cm / 6 1/2"
Stainless steel



Joseph
JO-21-194
16 cm / 6 1/4"
Single ended, 8 mm at wide point, fine cross serrations

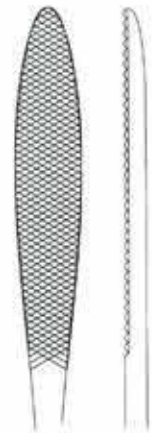



Lewis Rasp
19 cm / 7½"



JO-21-195
Fine, single ended
8 mm width

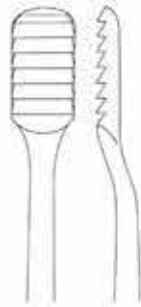

JO-21-196
Coarse, single ended
8 mm width
plain serrations



Cottle Rasp
JO-21-197
20.5 cm / 8"
Single ended, backward cutting
9 mm width
plain serrations



Miller-Colburn
JO-21-198
18 cm / 7"
Double ended, plain serrations

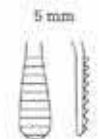

Miller-Colburn
JO-21-199
18 cm / 7"
Double ended, 5 mm width



Plain serrations

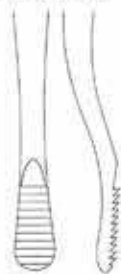

Miller-Colburn
JO-21-200
18 cm / 7"
Double ended, cross serrations



5 mm



Miller-Colburn
JO-21-201
21.5 cm / 8½"
Double ended, 13 mm width
Cross serrations, for rapid shaping of bone

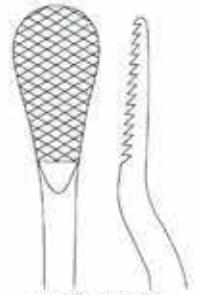

Fine serrations



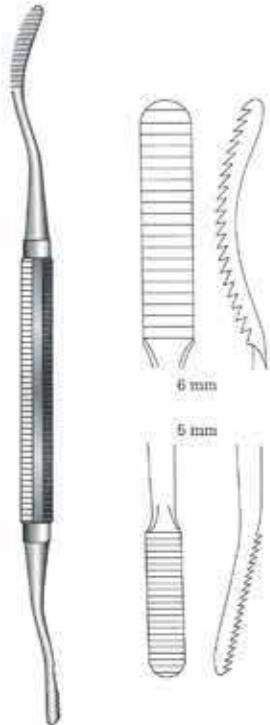

Miller-Colburn
JO-21-202
18.5 cm / 7 1/2"
Double ended, plain serrations

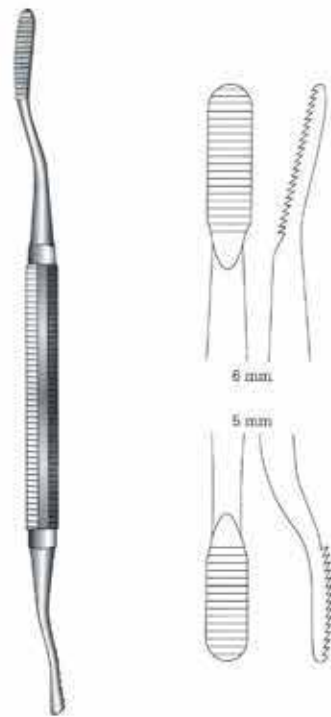

Miller-Colburn
JO-21-203
18 cm / 7"
Double ended, plain serrations



Miller-Colburn
JO-21-204
18 cm / 7"
Double ended, 5 mm width,
plain serrations



Polokoff Rasp
Double ended, plain serrations:



JO-21-205
18 cm / 7"



JO-21-206
21.5 cm / 8 1/2"
6 mm width

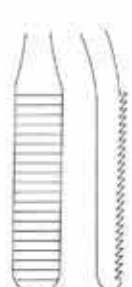

Miller-Colburn
JO-21-207
18 cm / 7"
Double ended

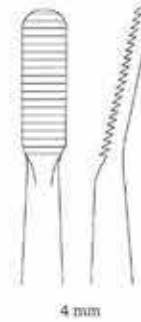

4 mm

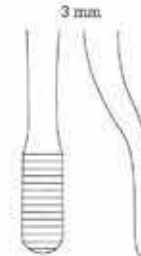

3 mm



Adson
JO-21-208
 15 cm / 6"
 Drill guide



JO-21-209
 14 cm / 5 1/2"



JO-21-210
 14 cm / 5 1/2"



JO-21-2270
 30 cm / 12"
 Straight ball spike



Perthes
JO-21-1595
 18 cm / 7"



Perthes
JO-21-211
 21 cm / 8 1/4"



Olivecrona
JO-21-212 30 cm / 12"
JO-21-213 40 cm / 16"
JO-21-214 50 cm / 20"
JO-21-215 70 cm / 28"

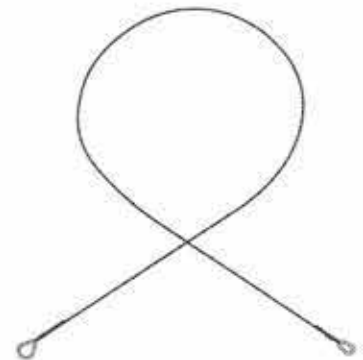

Gigli
JO-21-216 30 cm / 12"
JO-21-217 40 cm / 16"
JO-21-218 50 cm / 20"
JO-21-219 50 cm / 20"
 Fine, 6 wires twisted

Orthopedic

Amputating, Resection Saws & Handles

Amputation, Resektionssagen und griffe

Ampvtaoion, Sierras Para Reseeoion Y Mangos



Gigli
JO-21-220
Handle



Gigli
JO-21-1600
Handle with lock



Engel
JO-21-104



Lindemann
JO-21-221
20 cm / 8"



Langenbeck
JO-21-222
23 cm / 9"



Charriere
JO-21-223
35 cm / 14"



Charriere
JO-21-2500 27 cm / 10 3/4"
JO-21-2501 30 cm / 12"
JO-21-2502 34 cm / 13 1/2"



Satterlee
JO-21-225
30 cm / 12"
Blade 23 cm / 9"



SV-0651-30
 30 cm / 11 3/4"
 Blade 20 cm
 Post mortem saw



Butcher
SV-0652-00
 Blade 45 cm
 Post mortem saw



SV-0653-00
 Blade 40 cm
 Post mortem saw



Bier
JO-21-226
 42 cm / 16 1/2"
 Length of blade 27 cm / 10 1/2"
 Complete with one saw blade each
 4 mm, 6 mm, 8 mm



Rust
JO-21-230
 39 cm / 15 1/2"
 Length of blade
 Complete with one saw blade
 each 8 mm, 12 mm

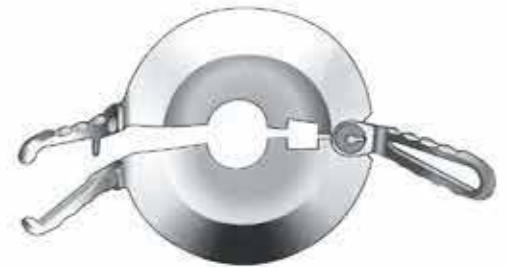

Percy
JO-21-231



Hudson
JO-21-233
Extension Piece



JO-21-234
9 mm \varnothing
Conical Burr



JO-21-235
14 mm \varnothing
Conical Burr



JO-21-236
16 mm \varnothing
Spherical Burr



JO-21-237
22 mm \varnothing
Spherical Burr



Hudson
27 cm / 10 $\frac{1}{2}$ "
JO-21-232
Complete set with Stainless steel handles
JO-21-2510
Complete set with Ferrozell handles
JO-21-2515
Complete set with Teflon handles



JO-21-238
14 mm \varnothing
Flat Trophine



JO-21-239
2 mm \varnothing
Twist Drill



JO-21-240
13 mm \varnothing
Burr



JO-21-241
16 mm \varnothing
Burr

Hudson
27 cm / 10 $\frac{1}{2}$ "
JO-21-2520
Brace only with Stainless steel handles
JO-21-2521
Brace only with Ferrozell handles
JO-21-2522
Brace only with Teflon handles



Stille-Sherman

JO-21-242
24 cm / 9 1/2"

JO-21-1742
Complete set



JO-21-243
2.5 mm Ø
Twist Drill



JO-21-244
3 mm Ø
Twist Drill



JO-21-245
3.5 mm Ø
Twist Drill



Stille

JO-21-246
20 cm / 8"

JO-21-1746
Complete set



JO-21-247
2.5 mm Ø
Twist Drill



JO-21-248
3 mm Ø
Twist Drill



JO-21-249
3.5 mm Ø
Twist Drill



JO-21-250
4 mm Ø
Twist Drill



JO-21-251
10 mm Ø
Trephine



JO-21-252
5 mm Ø
Spherical Burr



JO-21-253
8 mm Ø
Spherical Burr



JO-21-254
12 mm Ø
Spherical Burr



JO-21-255
16 mm Ø
Spherical Burr



JO-21-256
1 mm Ø
Twist Drill



JO-21-257
1.5 mm Ø
Twist Drill



JO-21-258
2 mm Ø
Twist Drill



JO-21-264

Handle with chuck and key, accommodating up to 6.35 mm (1/4"), perforated, for inserting and extracting nails, guide pins and wire guide drills.



JO-21-2535

Key only

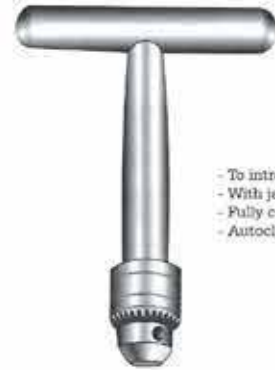

Pin Chuck

JO-21-2530 6.35 mm

15 cm / 6"

JO-21-2531 4.50 mm

14 cm / 5 1/2"

- To introduce bone pin
- With jacob chuck
- Fully cannulated
- Autoclaveable



JO-21-1156



Moore

JO-21-262



JO-21-2540

9 cm
3.2 mm Ø



JO-21-2541

7 cm
3.2 mm Ø

JO-21-263

Complete with a set of twist drill ref. JO-21-2640, JO-21-2641



Bunnell
JO-21-259
 24 cm / 9 1/2"



Ralk
JO-21-261
 Normal shaft
JO-21-2545
 Long shaft



Jacobs
JO-21-3200 Small
JO-21-3205 Large
 Stainless steel



JO-21-3210
 Key for Jacobs chuck
 Stainless steel



JO-21-3215 Small
JO-21-3220 Large
 Chrome plated
JO-21-3225 Small
JO-21-3230 Large
 Stainless steel



JO-21-3235
 Key for chuck

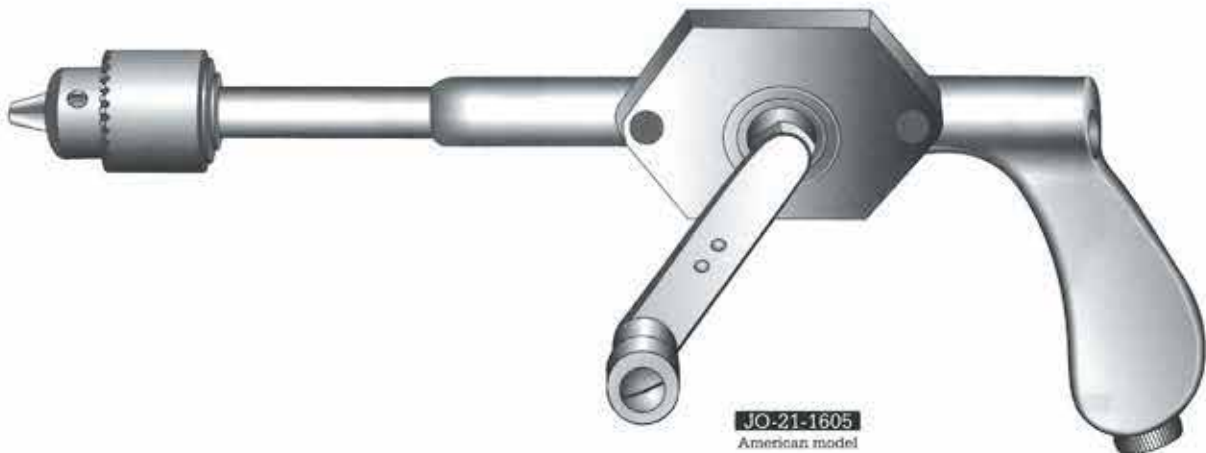

JO-21-1605
 American model



Williams
JO-21-2550
24 cm / 9 1/2"



JO-21-2560
17 cm / 6 3/4"
Ferrozell handle



Lane
JO-21-2565
25 cm / 10"
Ferrozell handle



JO-21-2570
17 cm / 6 3/4"
JO-21-2571
25 cm / 10"
Ferrozell handle



JO-21-2575
17 cm / 6 3/4"
JO-21-2576
25 cm / 10"
Ferrozell handle



Hexagon
JO-21-2580
17 cm / 6 3/4"
JO-21-2581
25 cm / 10"
Ferrozell handle



Hexagon
JO-21-2585
17 cm / 6 3/4"
JO-21-2586
25 cm / 10"
Ferrozell handle



Hexagon
JO-21-2590
17 cm / 6 3/4"
JO-21-2591
25 cm / 10"
Ferrozell handle



Hexagon
JO-21-2600
18 cm / 7"
1.5 mm tip
With sleeve



JO-21-2610
Sleeve only



JO-21-2605
2.5 mm



JO-21-2606
3.5 mm



JO-21-2607
4.5 mm



JO-21-1160 For children
JO-21-1161 For adults

Orthopedic

Nail Instruments, Finger Ring Saws

Instrumente Fur Finger-und Zehennagel, Fingerringagen

Instrumentos Para Unas, Sierras Para Abrir Anillos



JO-21-271
17 cm / 6 3/4"
Ring cutter



Walton
JO-21-272
16 cm / 6 1/4"
JO-21-2000
Spare blade for ring cutters



JO-21-273
17 cm / 6 3/4"
Ring cutter

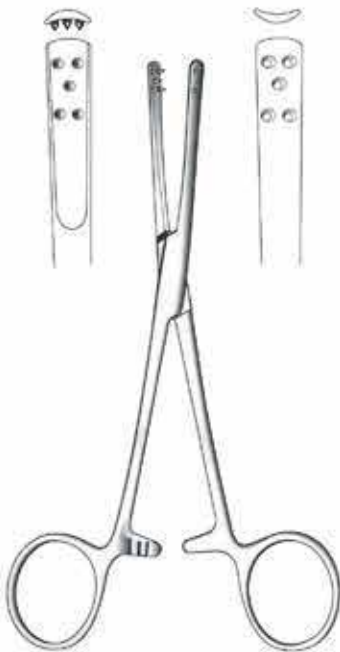

Penner
JO-21-274
15.5 cm / 6"



Radolf
JO-21-275
13.5 cm / 5 1/4"



JO-21-2614
14.5 cm / 5 3/4"
Nail extracting forceps



Coupe Clamp
JO-21-2615
14 cm / 5 1/2"
Plastic

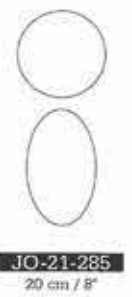
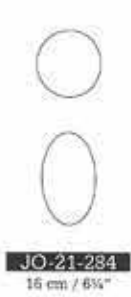
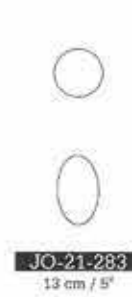



Volkmann
 17 cm / 6 3/4"

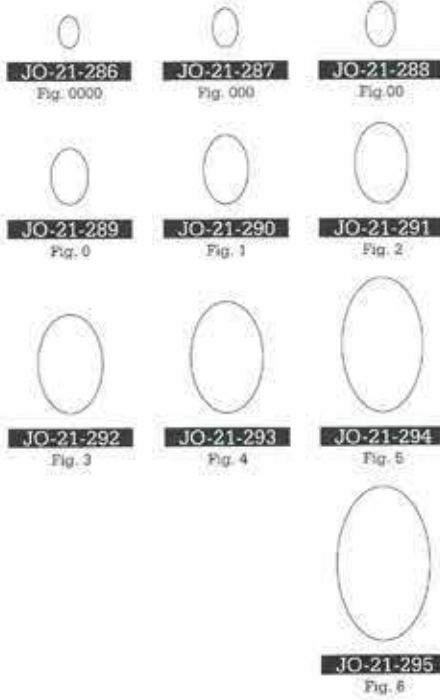

Spratt
 17 cm / 6 3/4"

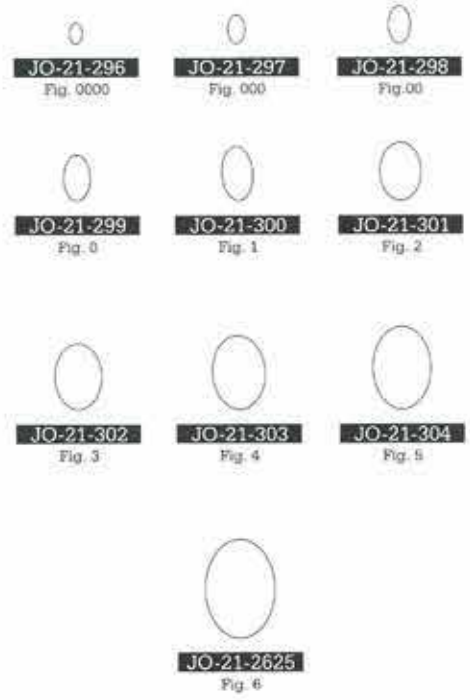

Bruns
 17 cm / 6 3/4"

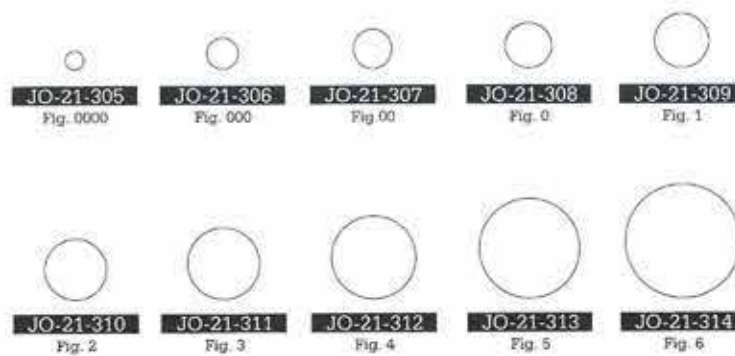



Schede

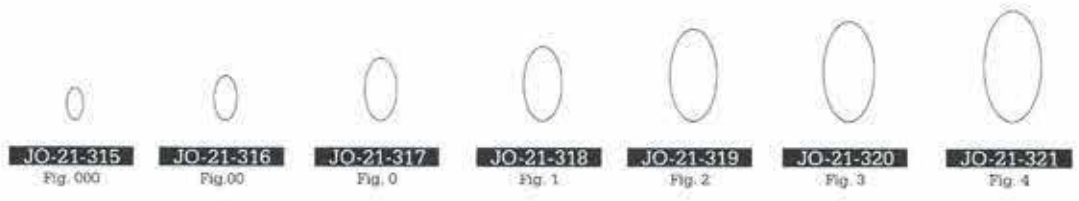

Williger
17,5 cm / 7"

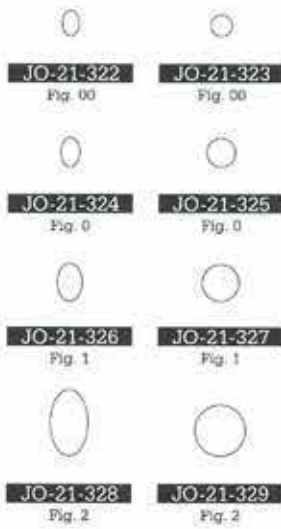





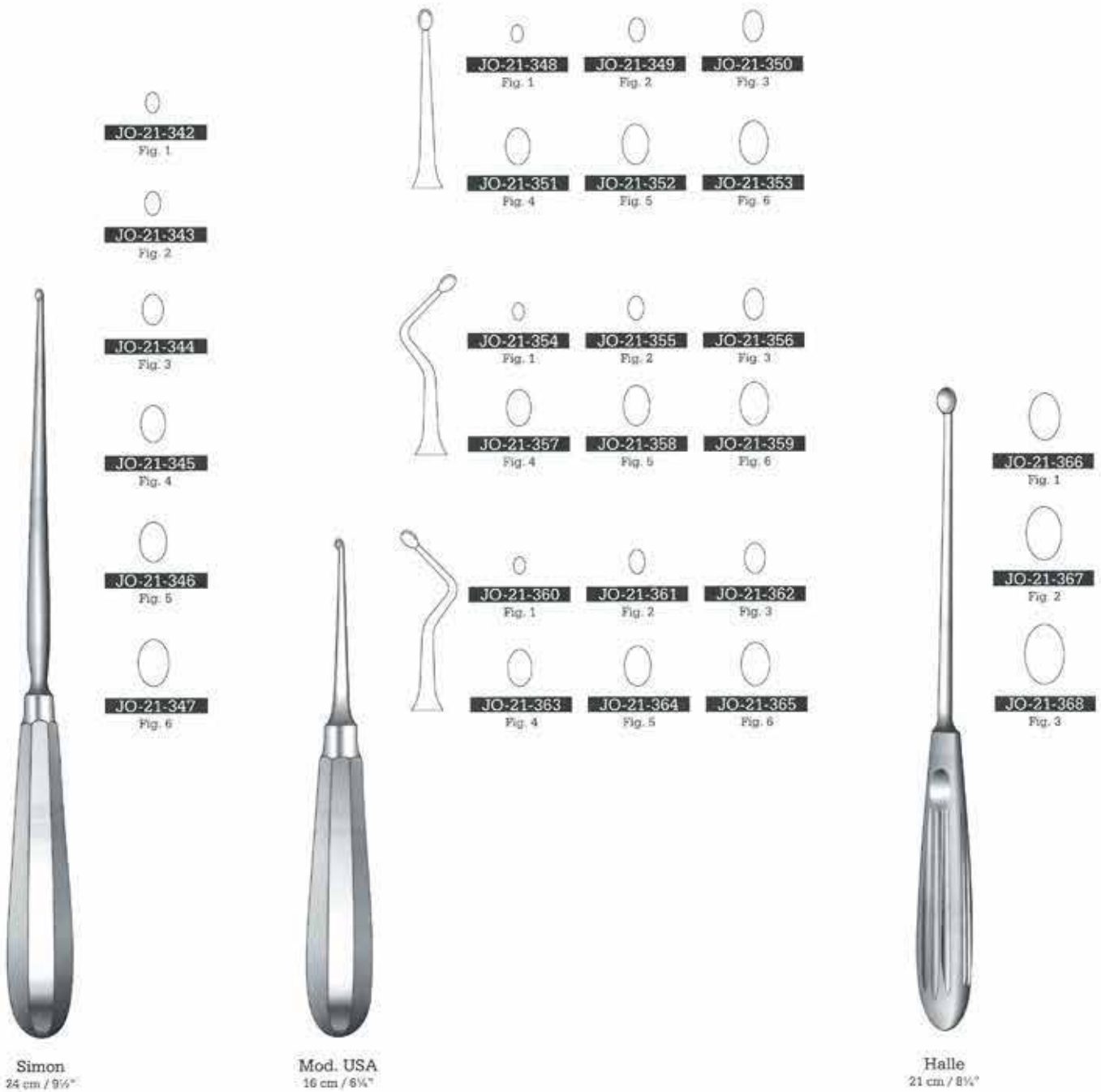

































25 cm / 9 7/8"





Add "T" to the item code for Teflon Handle.

			
JO-21-369 Fig. 0000	JO-21-379 Fig. 0	JO-21-384 Straight JO-21-393 Angled 45° Fig. 000	JO-21-402 Straight JO-21-411 Angled 45° Fig. 000
			
JO-21-371 Fig. 000	JO-21-380 Fig. 1	JO-21-385 Straight JO-21-394 Angled 45° Fig. 00	JO-21-403 Straight JO-21-412 Angled 45° Fig. 00
			
JO-21-373 Fig. 00	JO-21-381 Fig. 2	JO-21-386 Straight JO-21-395 Angled 45° Fig. 0	JO-21-404 Straight JO-21-413 Angled 45° Fig. 0
			
JO-21-375 Fig. 0	JO-21-382 Fig. 3	JO-21-387 Straight JO-21-396 Angled 45° Fig. 1	JO-21-405 Straight JO-21-414 Angled 45° Fig. 1
			
JO-21-377 Fig. 1	JO-21-383 Fig. 4	JO-21-388 Straight JO-21-397 Angled 45° Fig. 2	JO-21-406 Straight JO-21-415 Angled 45° Fig. 2
			
JO-21-370 Fig. 2		JO-21-389 Straight JO-21-398 Angled 45° Fig. 3	JO-21-407 Straight JO-21-416 Angled 45° Fig. 3
			
JO-21-372 Fig. 3		JO-21-390 Straight JO-21-399 Angled 45° Fig. 4	JO-21-408 Straight JO-21-417 Angled 45° Fig. 4
			
JO-21-374 Fig. 4		JO-21-391 Straight JO-21-400 Angled 45° Fig. 5	JO-21-409 Straight JO-21-418 Angled 45° Fig. 5
			
JO-21-376 Fig. 5		JO-21-392 Straight JO-21-401 Angled 45° Fig. 6	JO-21-410 Straight JO-21-419 Angled 45° Fig. 6
			
JO-21-378 Fig. 6			

			
Volkman 17 cm / 6 1/2" Ferrozoll handle	Volkman 27 cm / 10 3/4" Ferrozoll handle	Brun 23 cm / 9" With solid hexagonal handle	Cobb 28 cm / 11" Knurled handle Stainless steel

Orthopedic

Bone Osteotomes Chisels And Gouges

Meibels Und Osteotome

Cinceles Y Gubias Para Huesos



JO-21-420

8 mm

JO-21-421

10 mm

JO-21-422

12 mm

JO-21-423

14 mm

JO-21-424

16 mm

13.5 cm / 5 1/4"
Osteotomes

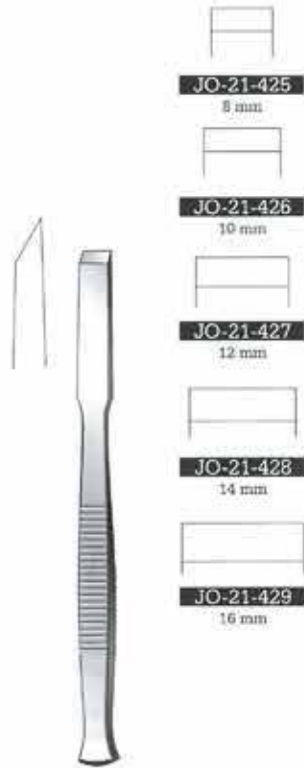

JO-21-425

8 mm

JO-21-426

10 mm

JO-21-427

12 mm

JO-21-428

14 mm

JO-21-429

16 mm

13.5 cm / 5 1/4"
Chisels



JO-21-430

8 mm

JO-21-431

10 mm

JO-21-432

12 mm

JO-21-433

14 mm

JO-21-434

16 mm

13.5 cm / 5 1/4"
Gouges



Gillies

JO-21-435 5 mm

JO-21-436 7 mm

JO-21-437 9 mm

14 cm / 5 1/2"
Osteotomes



Partsch

JO-21-438 3 mm

JO-21-439 4 mm

JO-21-440 5 mm

JO-21-441 6 mm

JO-21-442 7 mm

17 cm / 6 3/4"
Chisels



Partsch

JO-21-443 3 mm

JO-21-444 4 mm

JO-21-445 5 mm

JO-21-446 6 mm

JO-21-447 7 mm

17 cm / 6 3/4"
Gouges



	
JO-21-448 13.5 cm / 5 1/4" 2 mm	JO-21-449 17 cm / 6 3/4" 2 mm
	
JO-21-450 13.5 cm / 5 1/4" 3 mm	JO-21-451 17 cm / 6 3/4" 3 mm
	
JO-21-452 13.5 cm / 5 1/4" 4 mm	JO-21-453 17 cm / 6 3/4" 4 mm
	
JO-21-454 13.5 cm / 5 1/4" 5 mm	JO-21-455 17 cm / 6 3/4" 5 mm
	
JO-21-456 13.5 cm / 5 1/4" 6 mm	JO-21-457 17 cm / 6 3/4" 6 mm







Partsch
Chisels



	
JO-21-458 13.5 cm / 5 1/4" 2 mm	JO-21-459 17 cm / 6 3/4" 2 mm
	
JO-21-460 13.5 cm / 5 1/4" 3 mm	JO-21-461 17 cm / 6 3/4" 3 mm
	
JO-21-462 13.5 cm / 5 1/4" 4 mm	JO-21-463 17 cm / 6 3/4" 4 mm
	
JO-21-464 13.5 cm / 5 1/4" 5 mm	JO-21-465 17 cm / 6 3/4" 5 mm
	
JO-21-466 13.5 cm / 5 1/4" 6 mm	JO-21-467 17 cm / 6 3/4" 6 mm

Partsch
Gouges



		
JO-21-468 4 mm	JO-21-469 6 mm	JO-21-470 8 mm
		
JO-21-471 10 mm	JO-21-472 12 mm	JO-21-473 14 mm

Alexander
18 cm / 7"
Chisels



		
JO-21-474 4 mm	JO-21-475 6 mm	JO-21-476 8 mm
		
JO-21-477 10 mm	JO-21-478 12 mm	JO-21-479 14 mm

Alexander
18 cm / 7"
Gouge

Orthopedic

Bone Osteotomes Chisels And Gouges

Meibei Und Osteotome

Cinceles Y Gubias Para Huesos



Lucas
JO-21-480 4 mm
JO-21-481 6 mm
 16 cm / 6 1/4"



Lucas
JO-21-482 3 mm
JO-21-483 5 mm
 16 cm / 6 1/4"



Cottle
JO-21-484 4 mm
JO-21-485 6 mm
JO-21-486 8 mm
JO-21-487 10 mm
JO-21-488 12 mm
 18 cm / 7"
 With depth markings



Cottle
JO-21-489 4 mm
JO-21-490 7 mm
JO-21-491 9 mm
JO-21-492 12 mm
 18 cm / 7"
 With depth markings



Cottle
JO-21-493
 18 cm / 7"
 8 mm
 Fishtail chisel, with protected ends



East Grinstead (Ward)
JO-21-494 3 mm
JO-21-495 5 mm
 18 cm / 7"



Eastmann
JO-21-496 3 mm
JO-21-497 5 mm
 19 cm / 7 1/2"



East Grinstead (Ward)
JO-21-498 3 mm
JO-21-499 5 mm
 18 cm / 7"

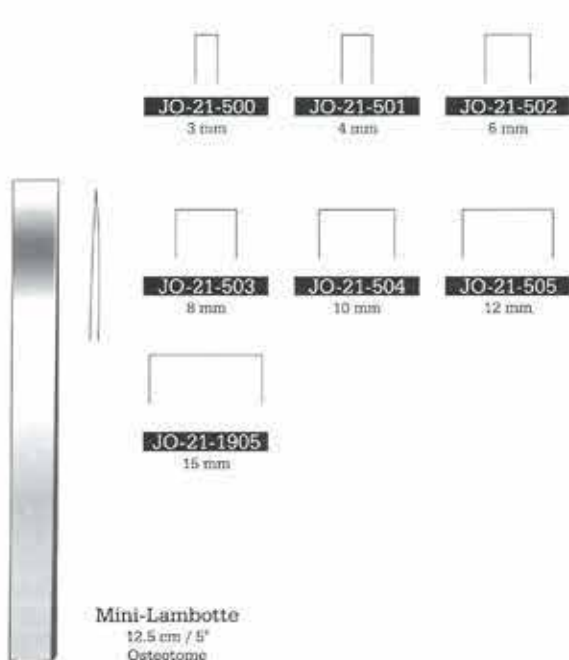

Mini-Lambotte
 12.5 cm / 5"
 Osteotome

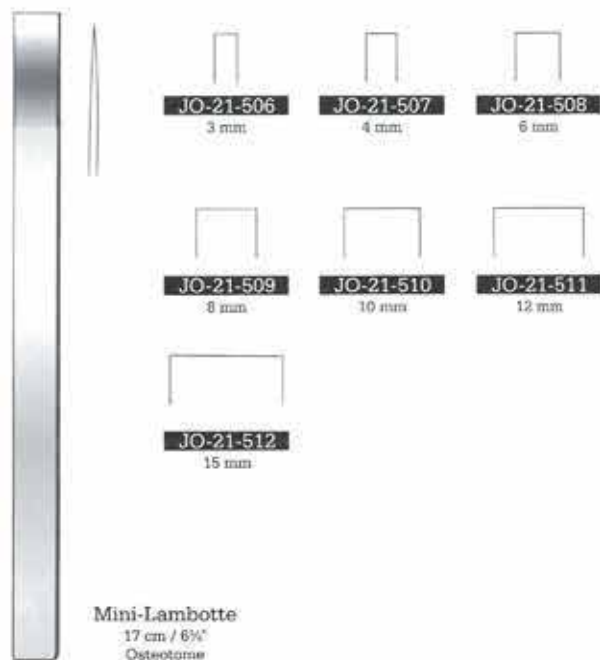

Mini-Lambotte
 17 cm / 6 1/2"
 Osteotome

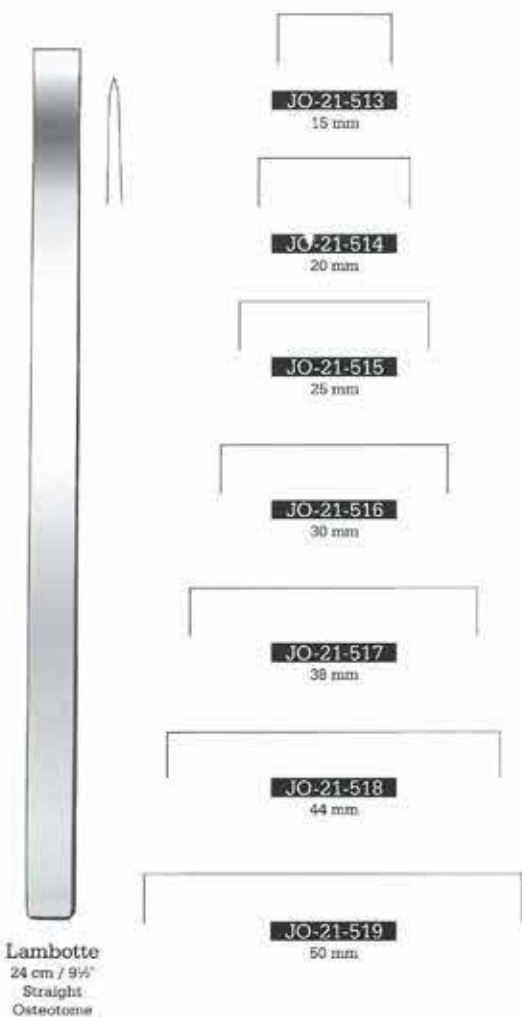

Lambotte
 24 cm / 9 1/2"
 Straight
 Osteotome

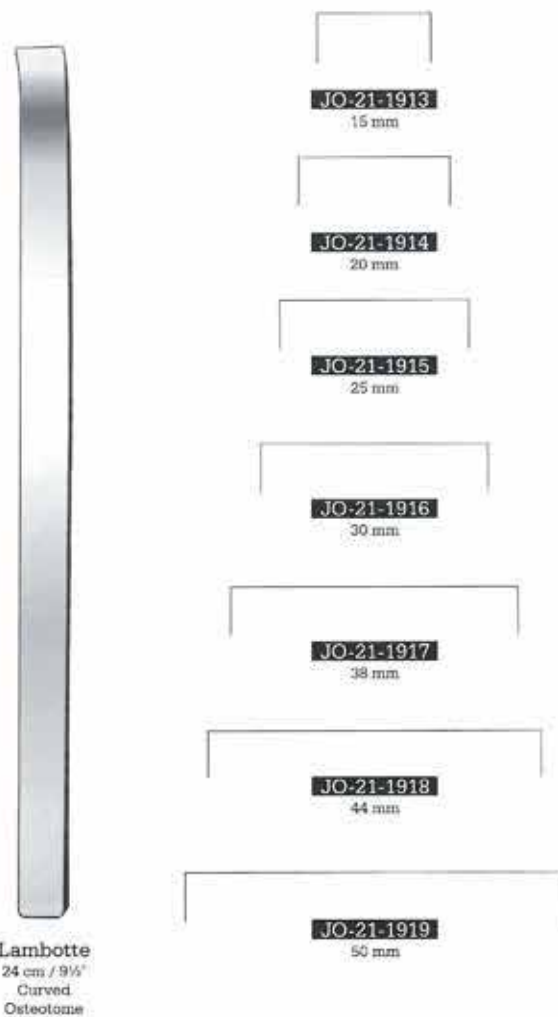

Lambotte
 24 cm / 9 1/2"
 Curved
 Osteotome

Add "N" to the item code for Teflon Handle.



Tessier
 20 cm / 7 7/8"

For taking grafts from ilium and tibia

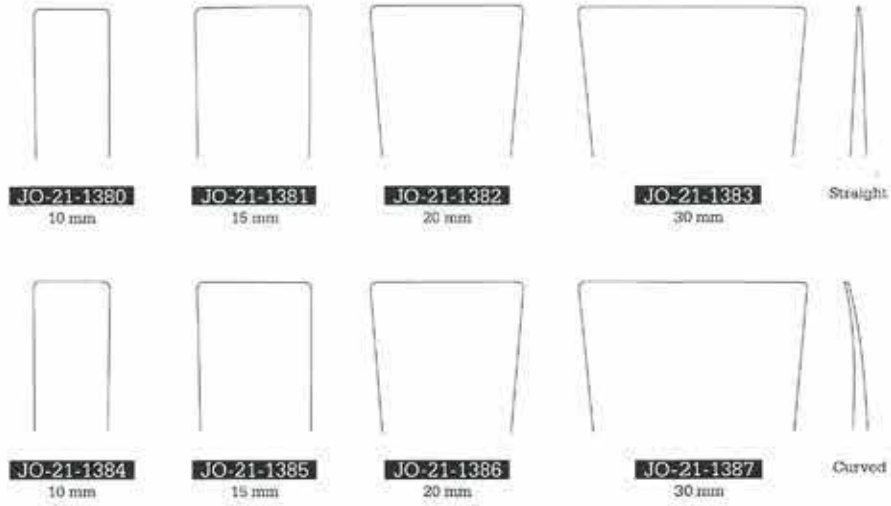

Tessier
 16 cm / 6 1/4"

For taking grafts from the calva

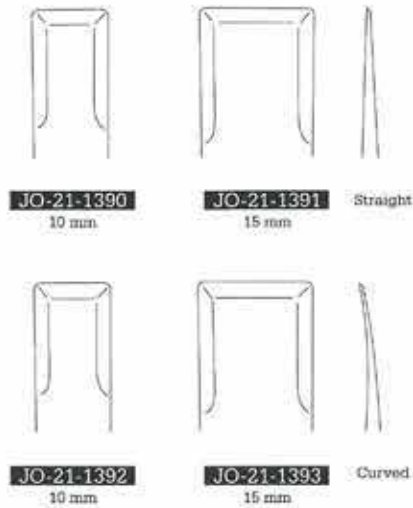

Key
JO-21-1388 19 cm / 7 1/2"
JO-21-1389 21 cm / 8 1/4"
 Periosteal elevator

Add "N" to the item code for Teflon Handle.



Stille

JO-21-521	10 mm
JO-21-522	12 mm
JO-21-523	15 mm
JO-21-524	20 mm
JO-21-525	25 mm

20.5 cm / 8"
Chisels



Stille

JO-21-526	10 mm
JO-21-527	12 mm
JO-21-528	15 mm
JO-21-529	20 mm
JO-21-530	25 mm

20.5 cm / 8"
Gouges



Stille

JO-21-531	10 mm
JO-21-532	12 mm
JO-21-533	15 mm
JO-21-534	20 mm
JO-21-535	25 mm

20.5 cm / 8"
Gouges
For taking grafts from the ribs



Stille

JO-21-2633	8 mm
JO-21-2634	10 mm
JO-21-2635	12 mm
JO-21-2636	15 mm
JO-21-2637	20 mm
JO-21-2638	25 mm

20.5 cm / 8"
Osteotomes



Stille

JO-21-539	10 mm
JO-21-540	12 mm
JO-21-541	15 mm
JO-21-542	20 mm
JO-21-543	25 mm

20.5 cm / 8"
Osteotomes, straight



Stille

JO-21-544	10 mm
JO-21-545	12 mm
JO-21-546	15 mm
JO-21-547	20 mm
JO-21-548	25 mm

20.5 cm / 8"
Osteotomes, curved

Add "N" to the item code for Teflon Handle. Add "Z" to the item code for Ferrozell Handle.

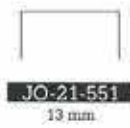

Smith Peterson
20 cm / 8"

Smith Peterson
20 cm / 8"

Smith Peterson
20 cm / 8"

Smith Peterson
20 cm / 8"

Add "N" to the item code for Teflon Handle. Add "Z" to the item code for Ferrozell Handle.



JO-21-571 24 cm / 9½"
JO-21-3111 18 cm / 7"
 6 mm

JO-21-572 24 cm / 9½"
JO-21-3112 18 cm / 7"
 13 mm

JO-21-573 24 cm / 9½"
JO-21-3113 18 cm / 7"
 19 mm

JO-21-574 24 cm / 9½"
JO-21-3114 18 cm / 7"
 25 mm

JO-21-575 24 cm / 9½"
 32 mm

Hibbs / Hilder
 Chisel



6 mm 10 mm 13 mm 16 mm

19 mm 25 mm

32 mm

JO-21-576 6 mm
JO-21-2640 10 mm
JO-21-577 13 mm
JO-21-2641 16 mm
JO-21-578 19 mm
JO-21-579 25 mm
JO-21-580 32 mm
 24 cm / 9½"
 Straight

JO-21-581 6 mm
JO-21-2642 10 mm
JO-21-582 13 mm
JO-21-2643 16 mm
JO-21-583 19 mm
JO-21-584 25 mm
JO-21-585 32 mm
 24 cm / 9½"
 Curved

JO-21-3121 6 mm
JO-21-3122 10 mm
JO-21-3123 13 mm
JO-21-3124 16 mm
JO-21-3125 19 mm
JO-21-3126 25 mm
JO-21-3127 32 mm
 18 cm / 7"
 Straight

JO-21-3131 6 mm
JO-21-3132 10 mm
JO-21-3133 13 mm
JO-21-3134 16 mm
JO-21-3135 19 mm
JO-21-3136 25 mm
JO-21-3137 32 mm
 18 cm / 7"
 Curved

Hibbs / Hilder
 Osteotome

Add "N" to the item code for Teflon Handle. Add "Z" to the item code for Ferrozell Handle.



JO-21-3141	6 mm	JO-21-586
JO-21-3142	13 mm	JO-21-587
JO-21-3143	19 mm	JO-21-588
JO-21-3144	25 mm	JO-21-589
JO-21-3145	32 mm	JO-21-590
18 cm / 7"		23 cm / 9"
Straight		Straight

Hilder
Gouge *

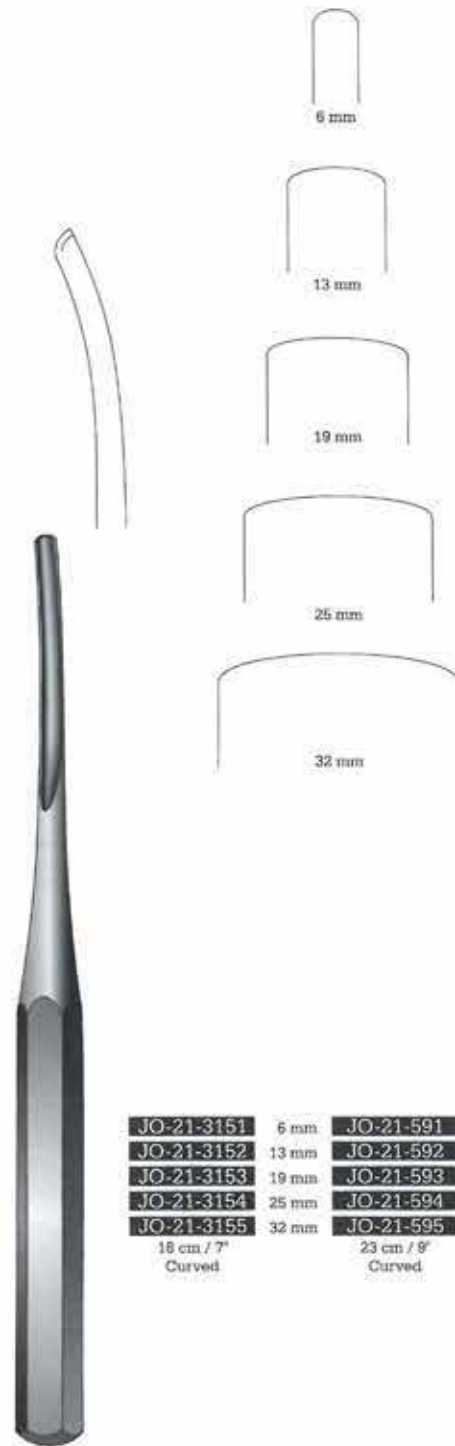

JO-21-3151	6 mm	JO-21-591
JO-21-3152	13 mm	JO-21-592
JO-21-3153	19 mm	JO-21-593
JO-21-3154	25 mm	JO-21-594
JO-21-3155	32 mm	JO-21-595
18 cm / 7"		23 cm / 9"
Curved		Curved

Hilder
Gouge

Add "N" to the item code for Teflon Handle. Add "Z" to the item code for Ferrozell Handle.

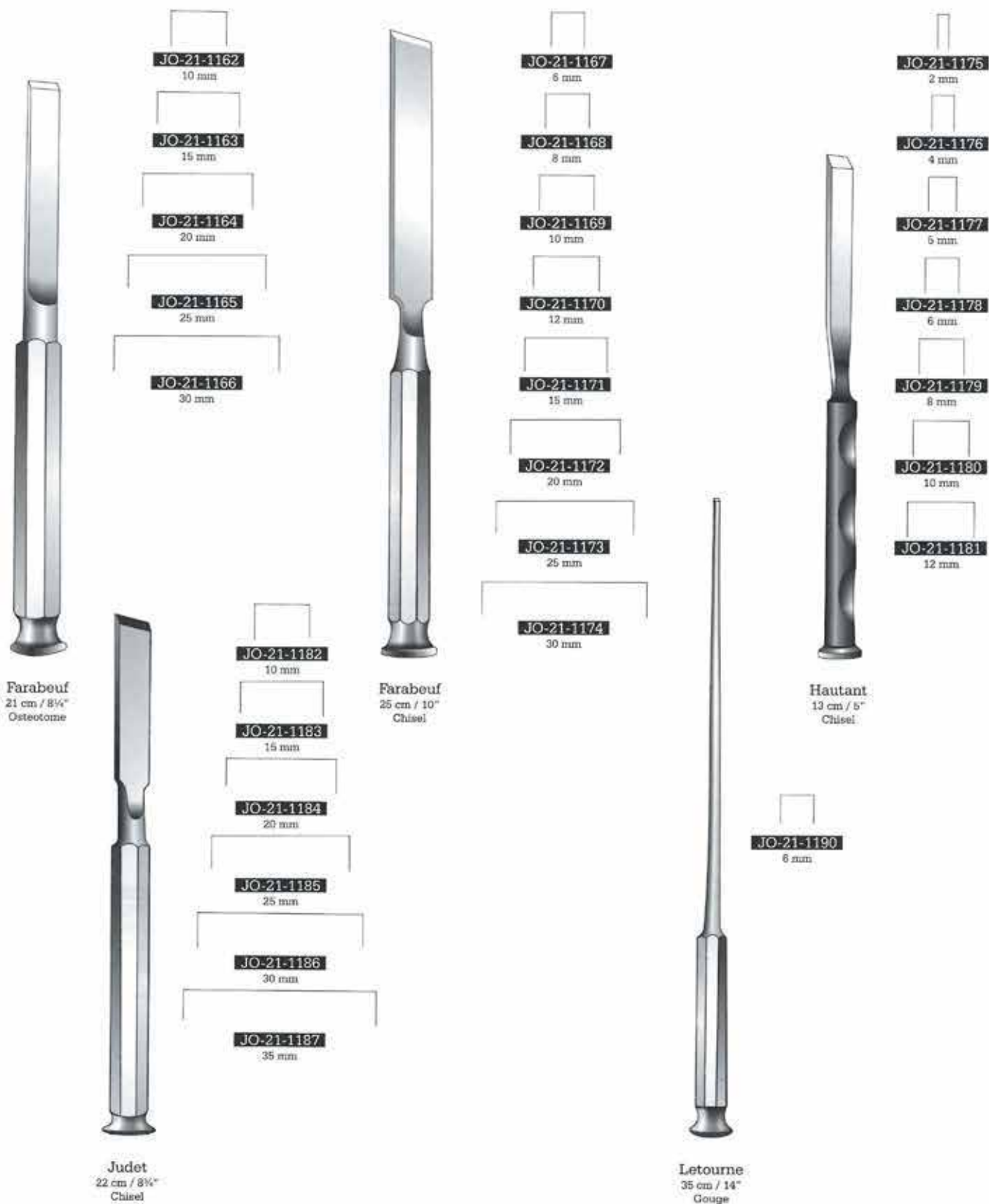

Add "N" to the item code for Teflon Handle. Add "Z" to the item code for Ferrozell Handle.



JO-21-1200
35 mm

Laucas Championniere
21 cm / 8 1/4"



JO-21-1201
10 mm

JO-21-1202
15 mm

JO-21-1203
20 mm

Maceven
20 cm / 8"



JO-21-1204
3.5 mm

Mante
13 cm / 5"



JO-21-1205
10 mm

JO-21-1206
15 mm

JO-21-1207
20 mm

Ombredanne
14 cm / 5 1/2"



JO-21-1210 14 cm / 5 1/2"
JO-21-1211 17 cm / 6 3/4"

2 mm

JO-21-1212 14 cm / 5 1/2"
JO-21-1213 17 cm / 6 3/4"

3 mm

JO-21-1214 14 cm / 5 1/2"
JO-21-1215 17 cm / 6 3/4"

4 mm

JO-21-1216 14 cm / 5 1/2"
JO-21-1217 17 cm / 6 3/4"

6 mm

JO-21-1218 14 cm / 5 1/2"
JO-21-1219 17 cm / 6 3/4"

8 mm

Partsch



JO-21-1230
4 mm

JO-21-1231
6 mm

JO-21-1232
8 mm

JO-21-1233
10 mm

JO-21-1234
12 mm

JO-21-1235
14 mm

Poirier
16 cm / 6 1/4"



JO-21-1236
6 mm

JO-21-1237
8 mm

JO-21-1238
10 mm

JO-21-1239
12 mm

Portmann
16 cm / 6 1/4"

Add "N" to the item code for Teflon Handle. Add "Z" to the item code for Ferrozell Handle.

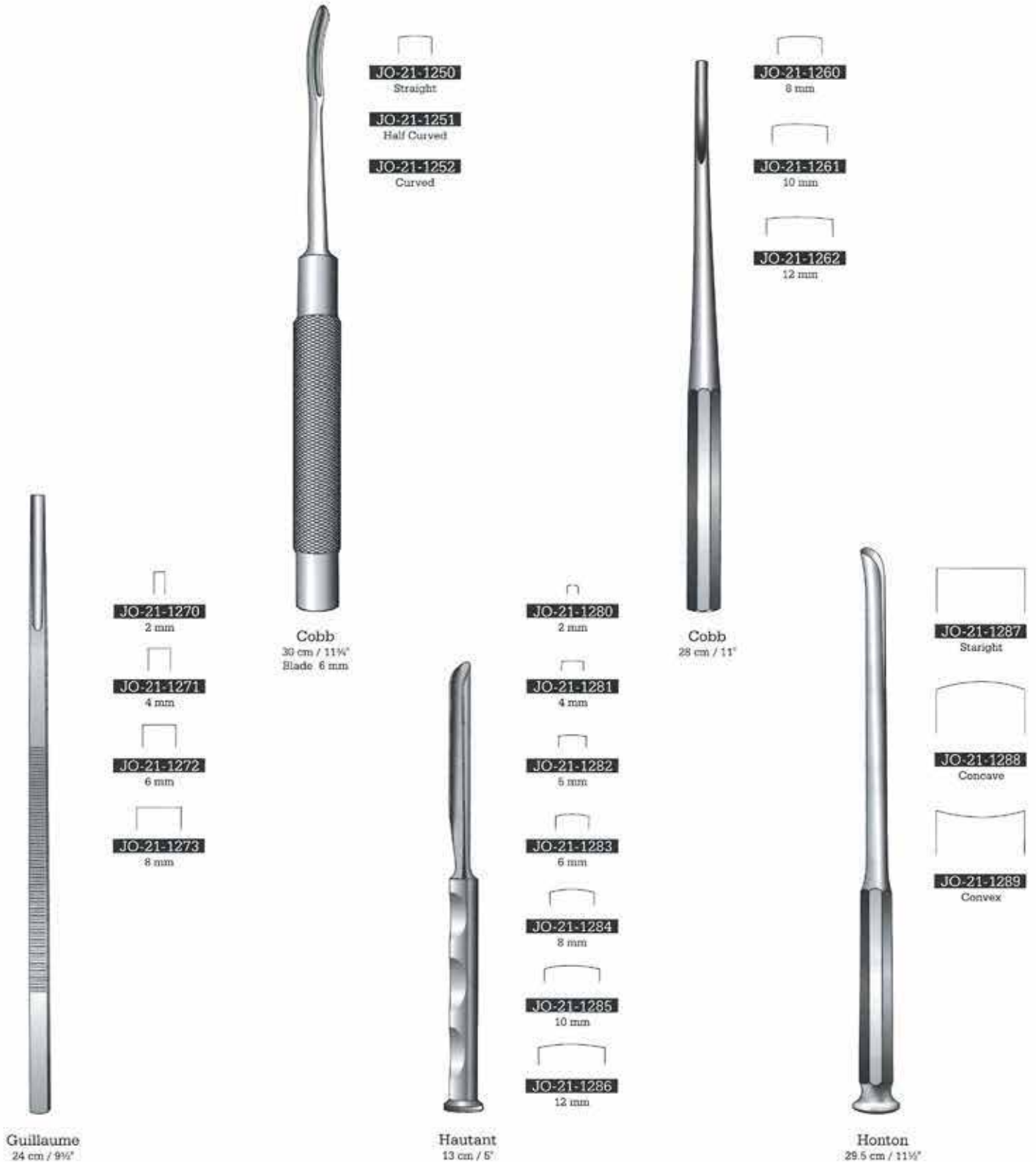

Add "N" to the item code for Teflon Handle. Add "Z" to the item code for Ferrozell Handle.

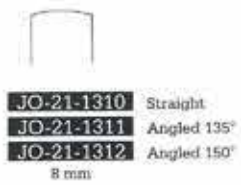

Add "N" to the item code for Teflon Handle. Add "Z" to the item code for Ferrozell Handle.

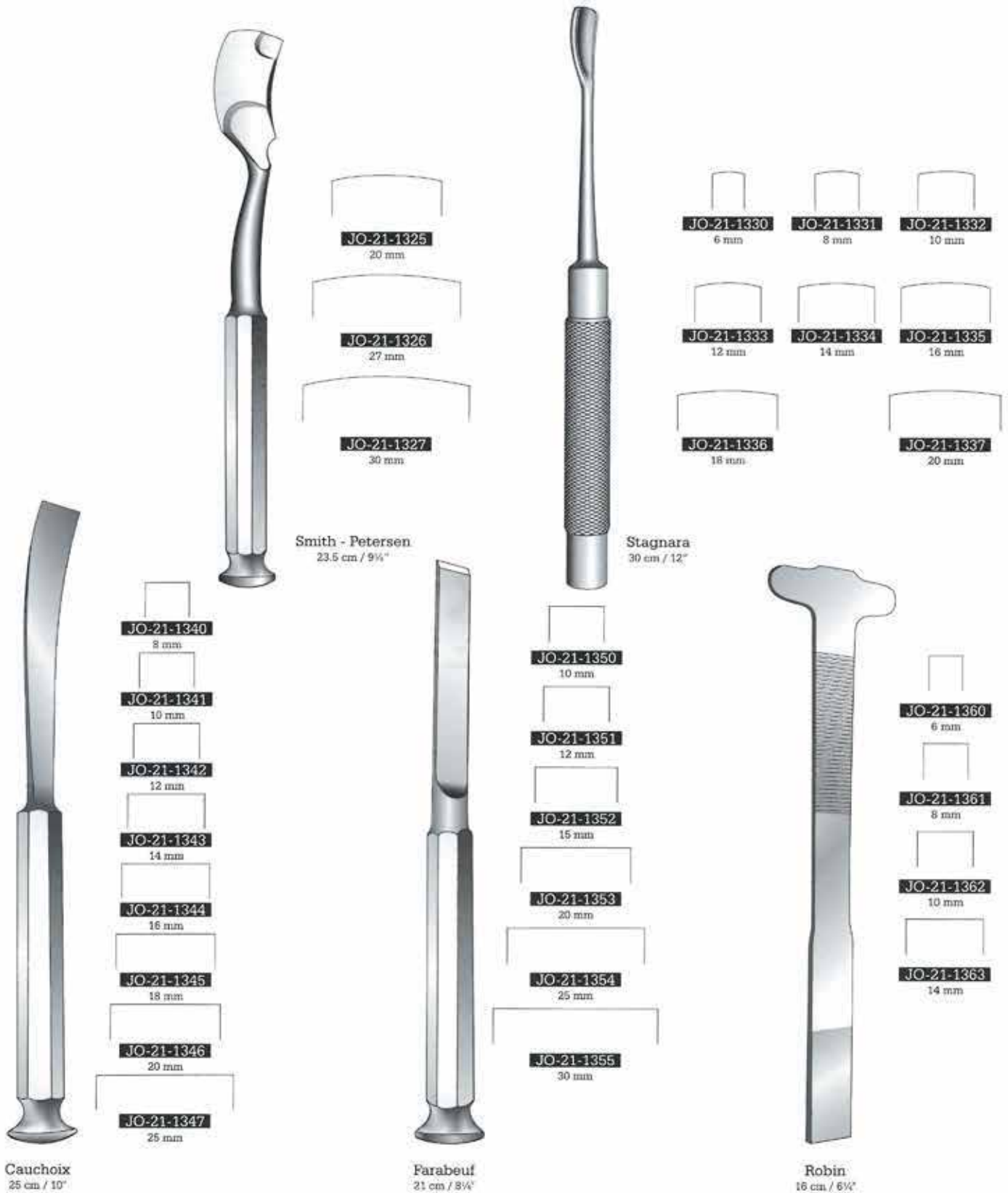

Add "N" to the item code for Teflon Handle. Add "Z" to the item code for Ferrozell Handle.



Lebsche
J-28-120
 24.5 cm / 9 3/4"



Virchow
JO-21-1620
 Skull breaker



Brunetti
JO-21-1630
 28 cm / 11"
 Left



Brunetti
JO-21-1635
 28 cm / 11"
 Right



JO-21-1625
 22 cm / 8 3/4"



Cobb
JO-21-601 Tip 10 mm
JO-21-602 Tip 13 mm
JO-21-603 Tip 19 mm
 29 cm / 11 1/2"
 Spinal elevator

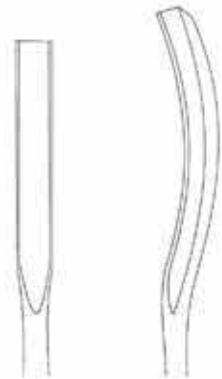

JO-21-605 Straight
JO-21-606 Medium curve

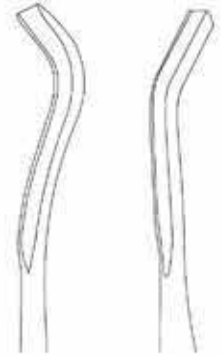

JO-21-607 Strong curve
JO-21-608 Reverse curve



Cobb
 28 cm / 11"
 Spinal gouge
 7 mm blade width

Add "N" to the item code for Teflon Handle.

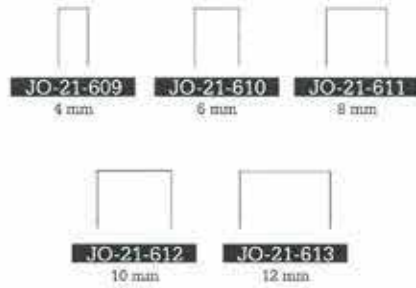

Mini-Lexer
 18 cm / 7"
 Ferrozell handle

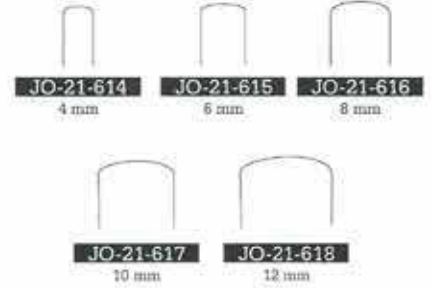

Mini-Lexer
 18 cm / 7"
 Ferrozell handle

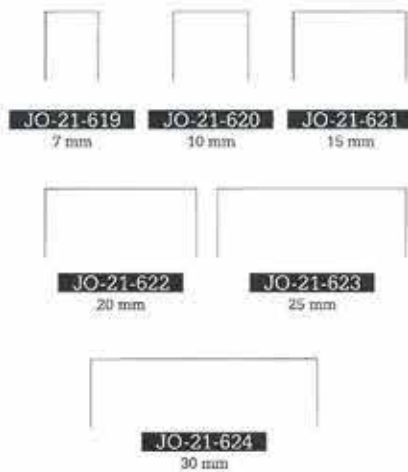

Lexer
 22 cm / 8 3/4"
 Ferrozell handle

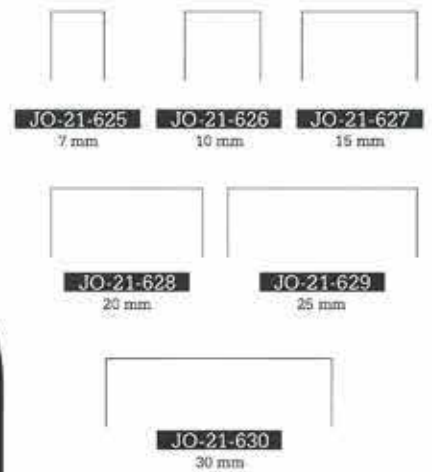

Lexer
 22 cm / 8 3/4"
 Ferrozell handle

Orthopedic

Wedge Osteotomes, Blade Osteotomes

Keilosteotome, Blattosteotome

Osteotomos de Cuna, Osteotomos de Hojas



Add "N" to the item code for Teflon Handle.



JO-21-1400
8 mm



JO-21-1401
12 mm



JO-21-1402
16 mm



JO-21-1410
8 mm



JO-21-1411
12 mm



JO-21-1412
16 mm



JO-21-1413
20 mm



Obwegeser
22 cm / 8 3/4"



Obwegeser
22 cm / 8 3/4"

Add "N" to the item code for Teflon Handle.

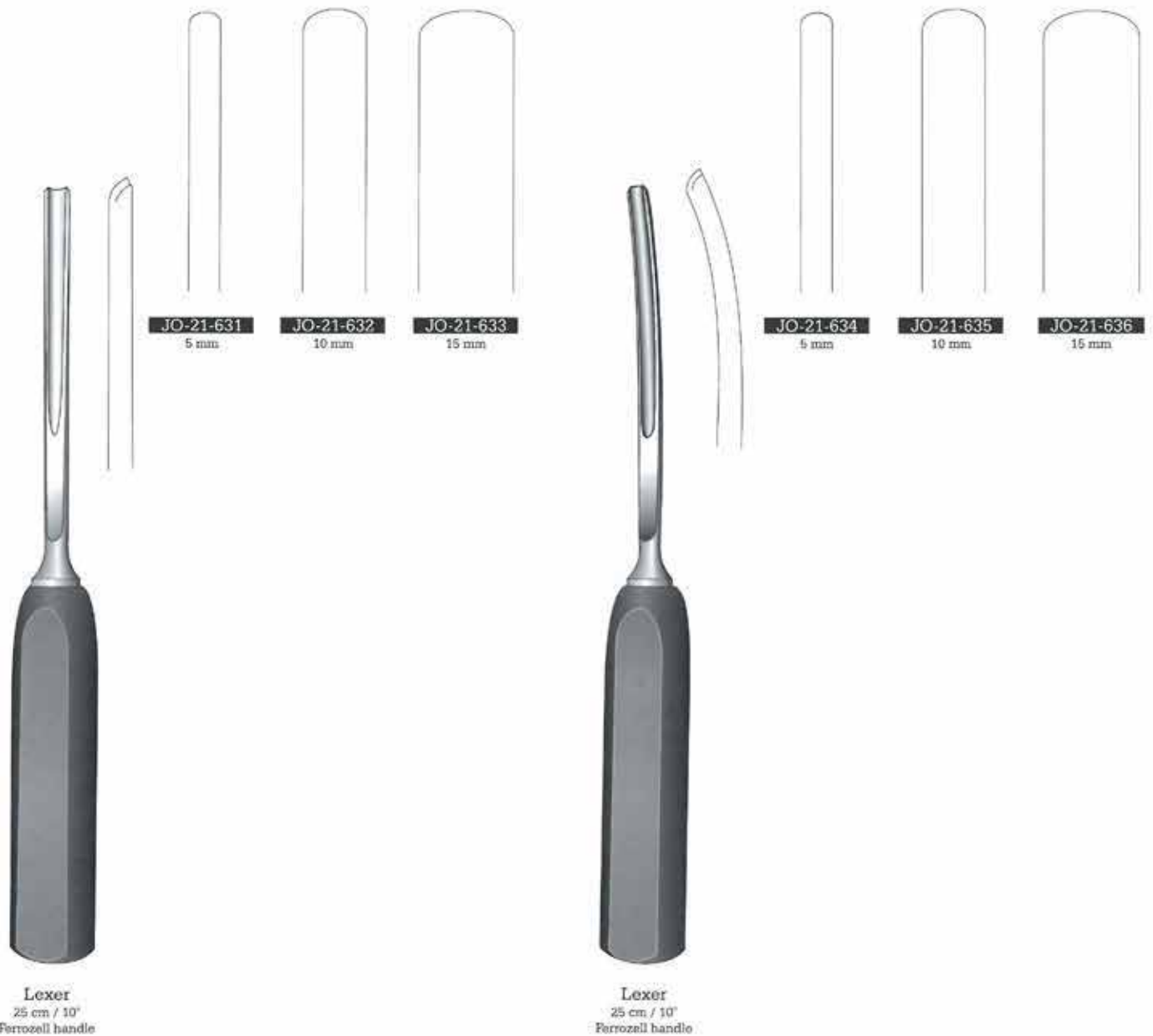

Add "N" to the item code for Teflon Handle.



JO-21-637
 24.5 cm / 9 1/2"
 20 mm
 Ferrozell handle

JO-21-638
 26.5 cm / 10 1/2"
 18 mm
 Ferrozell handle, curved

Lexer
JO-21-639 10 mm
JO-21-2039 15 mm
 27.5 cm / 10 3/4"
 Ferrozell handle

Lexer
JO-21-640 10 mm
JO-21-2040 15 mm
 27.5 cm / 10 3/4"
 Ferrozell handle

Add "N" to the item code for Teflon Handle.



JO-21-641	5 mm
JO-21-642	10 mm
JO-21-643	15 mm

25 cm / 10"
 Ferrozell handle
 Spongiosa gouge



Lamina

JO-21-644	5 mm
JO-21-645	8 mm
JO-21-646	11 mm
JO-21-647	16 mm

23.5 cm / 9 1/2"
 Ferrozell handle



JO-21-648	5 mm
JO-21-649	10 mm
JO-21-650	15 mm

25 cm / 10"
 Curved
 Ferrozell handle
 Spongiosa gouge

Add "N" to the item code for Teflon Handle.



Lexer
29 cm / 11"
Ferozell handle
Spongiosa gouge



JO-21-651



JO-21-652



Wagner
34 cm / 13 1/2"
Ferozell handle

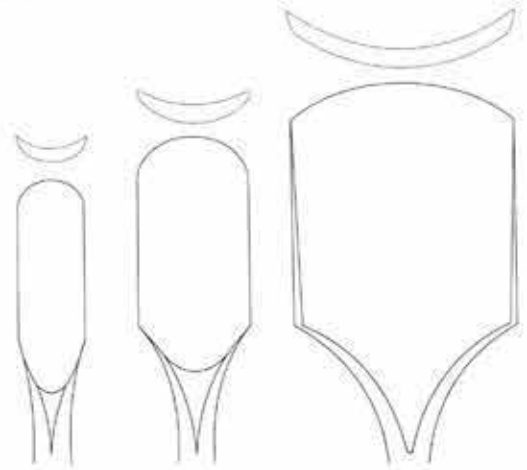

9 mm

15 mm

30 mm



JO-21-653

JO-21-654

JO-21-2054

Inclined forward



JO-21-655

JO-21-656

JO-21-2056

Inclined backward



JO-21-657

JO-21-658

JO-21-2058

Straight

9 mm

15 mm

30 mm

Long handled thin concave osteotomes for removal of osteophytes as well as for creating small notches throughout the acetabular surface. The instruments can also be used for removing bone cement from the narrow cavity when removing a total hip prosthesis.

Add "N" to the item code for Teflon Handle



JO-21-2100
 18.5 cm / 7 3/8"
 Handle, only
 Ferrozell handle

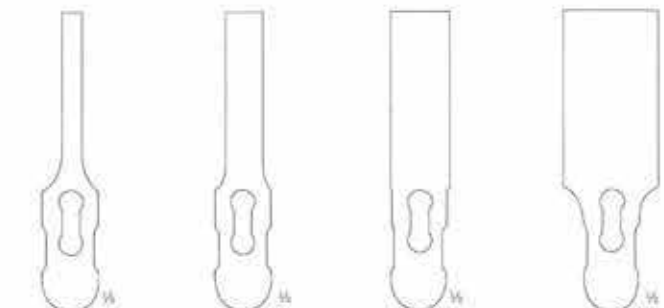

5 mm	10 mm	16 mm	25 mm
JO-21-2110	JO-21-2111	JO-21-2112	JO-21-2113
8.5 cm / 3 3/8"	8.5 cm / 3 3/8"	8.5 cm / 3 3/8"	8.5 cm / 3 3/8"

Osteotome blades,
interchangeable

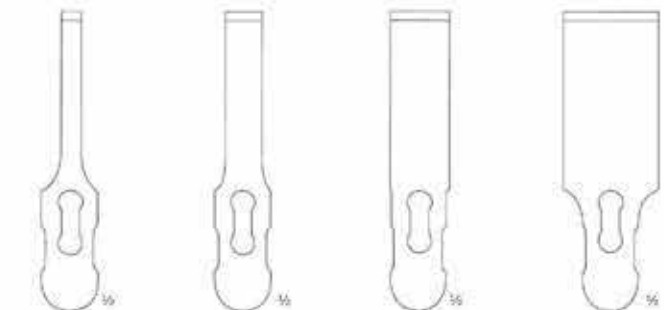

5 mm	10 mm	16 mm	25 mm
JO-21-2120	JO-21-2121	JO-21-2122	JO-21-2123
8.5 cm / 3 3/8"	8.5 cm / 3 3/8"	8.5 cm / 3 3/8"	8.5 cm / 3 3/8"

Chisel blades,
interchangeable

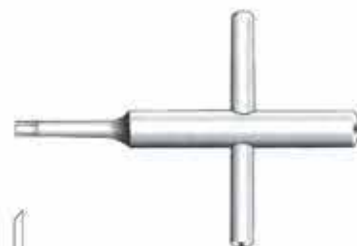

JO-21-2140
 9 cm / 3 5/8"
 Key
JO-21-2150
 Spare Screw



Gouge blades,
interchangeable





Volkmann
JO-21-659
 20 cm / 8"
 19 x 27 mm
 Sharp



Volkmann
JO-21-660
 23 cm / 9"
 16 x 20 mm
 Sharp



Volkmann
JO-21-661
 25 cm / 9 3/4"
 15 x 20 mm
 Sharp



23 cm / 9"
 Sharp
 Bone hook with grip handle



JO-21-664
 6 x 10 mm
 Small



JO-21-665
 11 x 18 mm
 Medium



JO-21-666
 12 x 30 mm
 Large



JO-21-667
 18 cm / 7"
 18 x 21 mm
 Sharp with T-handle
 large, for femurs



Zygoma
JO-21-1655
 17 cm / 6 3/4"

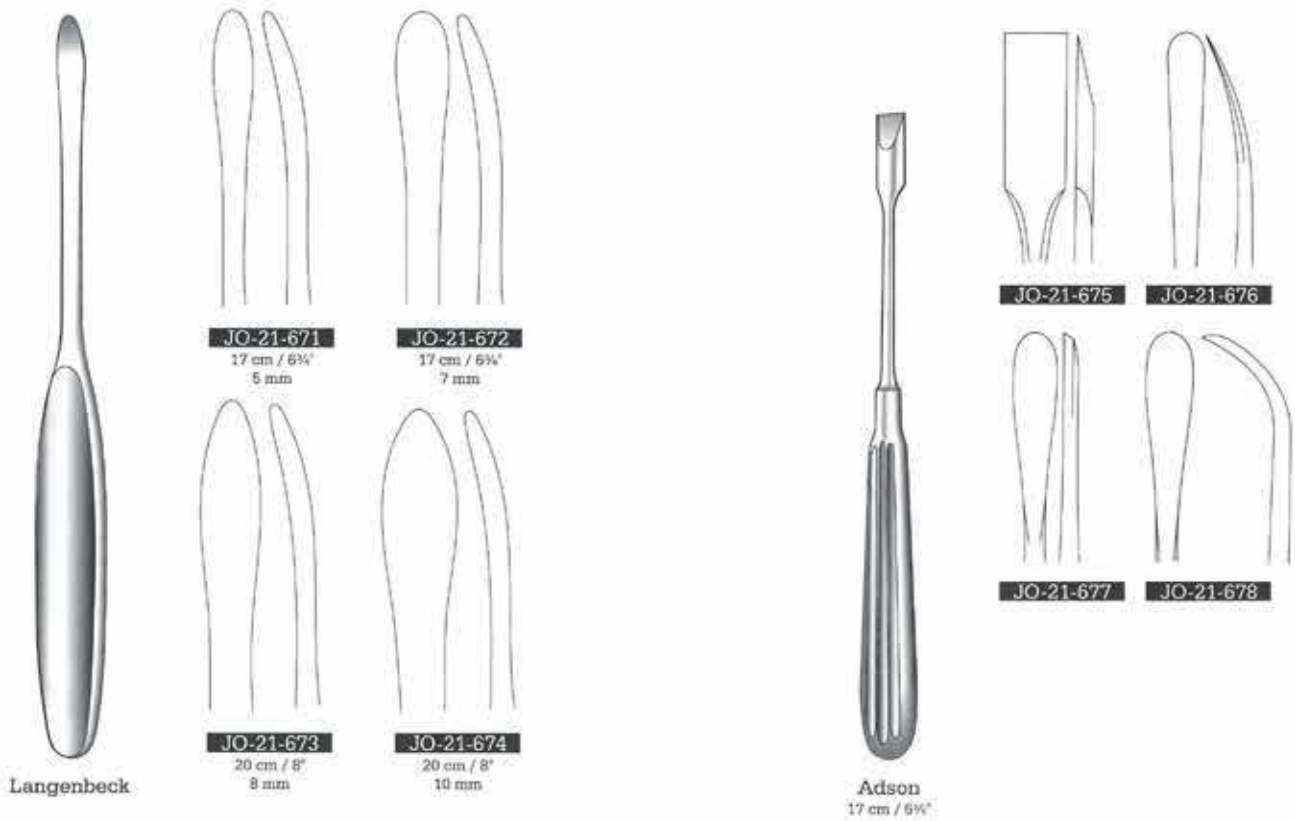
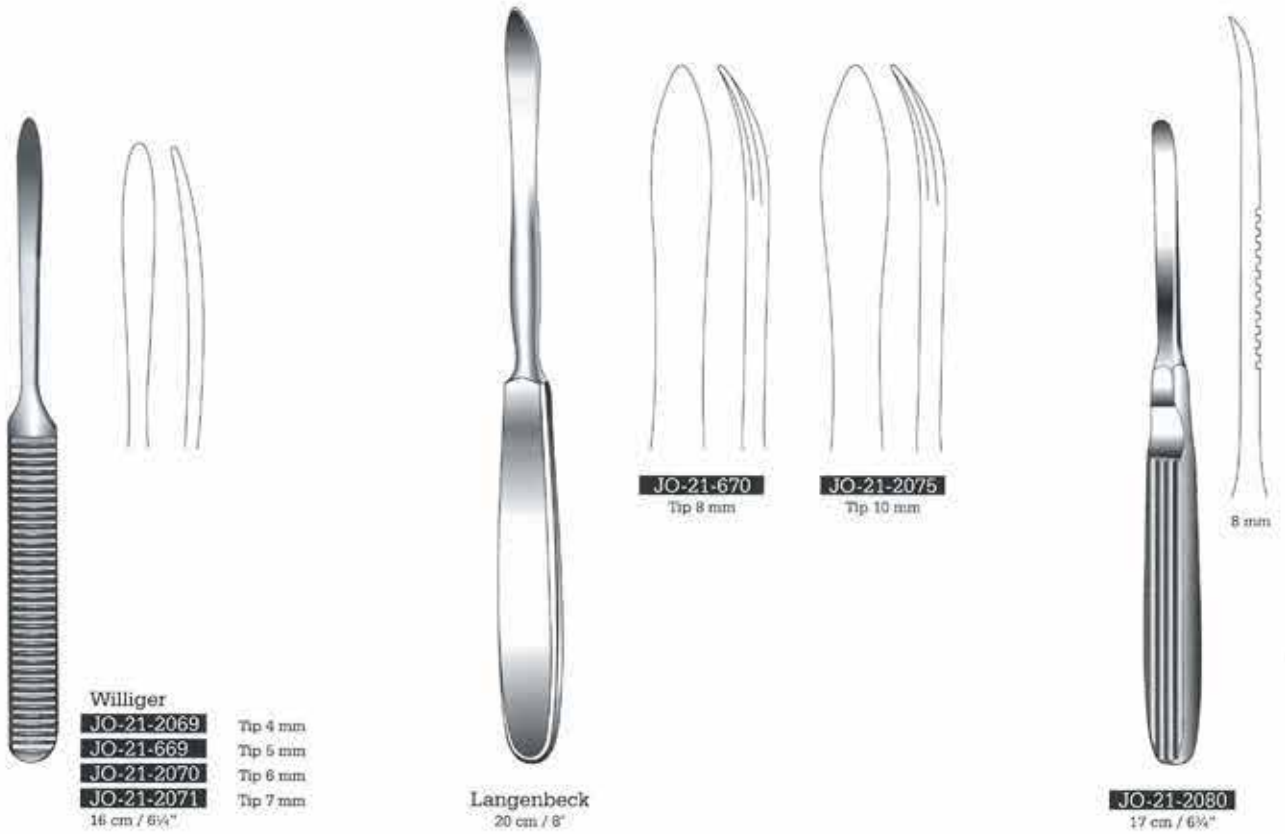



Matson
JO-21-679
22 cm / 8 3/4"

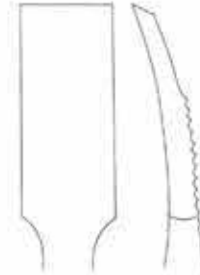

Alexander
JO-21-680
20 cm / 8"



Semb



JO-21-681
17.5 cm / 7"



JO-21-682
21 cm / 8 1/4"



JO-21-683
17.5 cm / 7"



JO-21-684
21 cm / 8 1/4"



JO-21-685
20.5 cm / 8"



Doyen
 17 cm / 6 3/4"

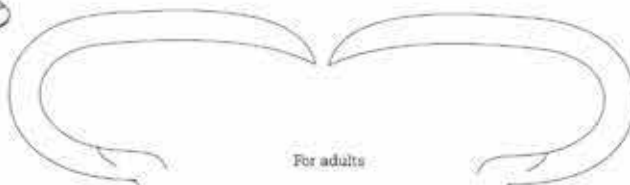

JO-21-686
 Right

For adults

JO-21-687
 Left

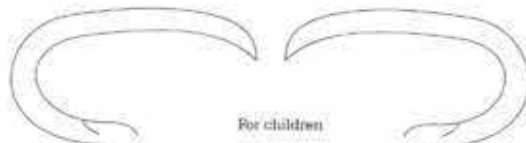

JO-21-688
 Right

For children

JO-21-689
 Left



Williger
JO-21-690
 13 cm / 5"
 5 mm



Williger
JO-21-691 4 mm
JO-21-1991 5 mm
JO-21-1992 6 mm
JO-21-1993 7 mm
 16 cm / 6 1/4"



17 cm / 6 3/4"

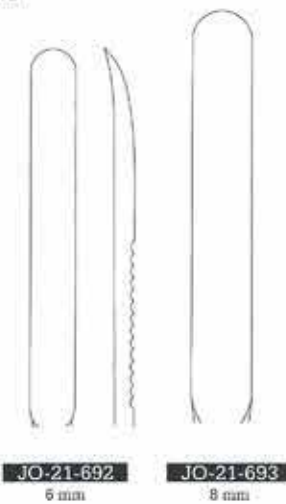

JO-21-692
 6 mm

JO-21-693
 8 mm



Lambotte
 21 cm / 8 1/4"

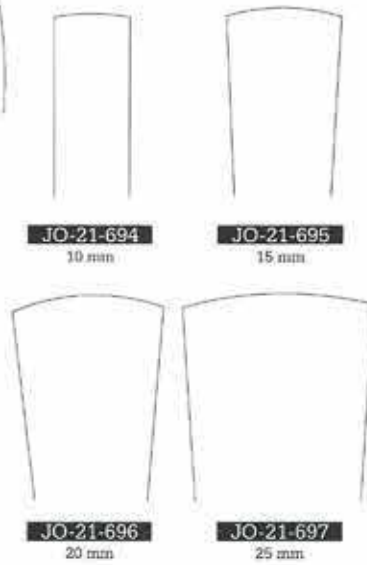

JO-21-694
 10 mm

JO-21-695
 15 mm

JO-21-696
 20 mm

JO-21-697
 25 mm

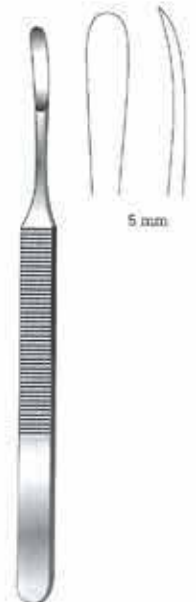

Konig
JO-21-1990
 15.5 cm / 6"



Farabeuf
JO-21-698
 15 cm / 6"
 Straight



Farabeuf
JO-21-699
 15 cm / 6"
 Curved

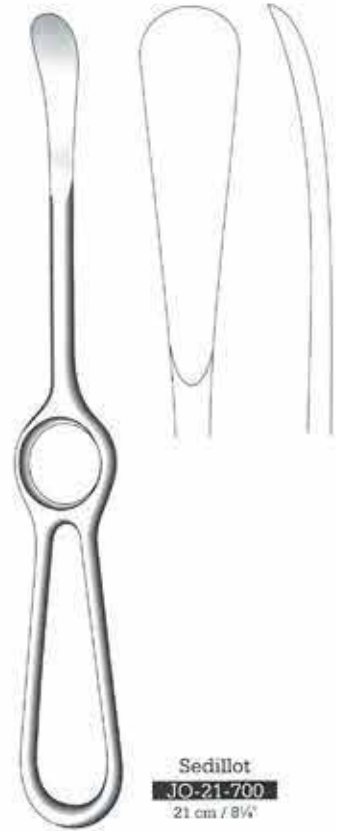

Sedillot
JO-21-700
 21 cm / 8 1/4"



16 cm / 6 3/8"
 Delicate, Solid

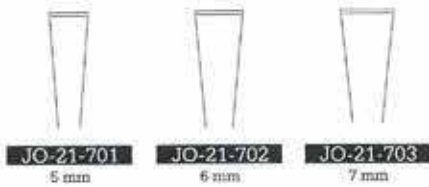

JO-21-701
 5 mm

JO-21-702
 6 mm

JO-21-703
 7 mm

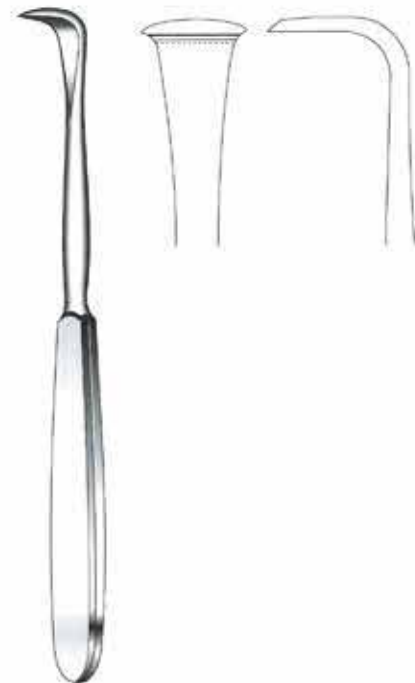

Langenbeck
JO-21-704
 18 cm / 7"

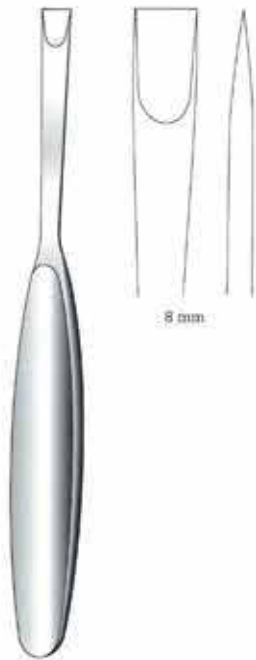

Cushing
JO-21-705
 17 cm / 6 3/4"



Cushing



JO-21-706
 17 cm / 6 3/4"
 4 mm



JO-21-707
 17 cm / 6 3/4"
 6 mm



JO-21-708
 19.5 cm / 7 3/4"
 5 mm

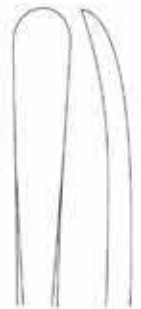

JO-21-709
 19.5 cm / 7 3/4"
 7 mm



Langenbeck



JO-21-710
 19 cm / 7 1/2"
 16 mm



JO-21-711
 19 cm / 7 1/2"
 16 mm



JO-21-712
 19 cm / 7 1/2"
 12 mm



JO-21-713
 18 cm / 7"
 12 mm



Hoen



JO-21-714
 16 cm / 6 1/4"
 7 mm



JO-21-715
 18 cm / 7 1/4"
 15 mm



JO-21-716
 19 cm / 7 1/2"
 20 mm

Add "N" to the item code for Teflon Handle. Add "Z" to the item code for Ferrozell Handle.



6 mm

JO-21-717
 18 cm / 7"
 Ferrozell handle



6 mm

JO-21-718
 18 cm / 7"
 Ferrozell handle



3 mm

JO-21-719
 18 cm / 7"
 Ferrozell handle



14 mm

JO-21-720
 20 cm / 8"
 Ferrozell handle



14 mm

JO-21-721
 20 cm / 8"
 Ferrozell handle



19 mm

JO-21-722
 20 cm / 8"
 Ferrozell handle



JO-21-723
16 mm



JO-21-724
14 cm / 5 1/2"



JO-21-2024
15 cm / 6"
5 mm



JO-21-2026
15 cm / 6"
7 mm

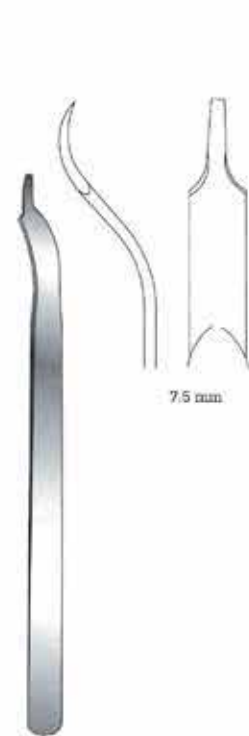

Buck-Gramcko
JO-21-2028
15 cm / 6"

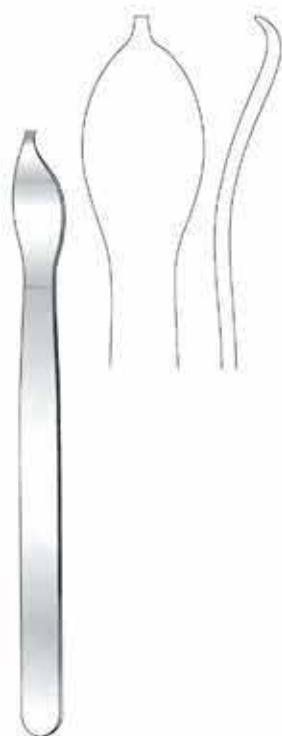

JO-21-725
15 mm



JO-21-726
6 mm

JO-21-727
8 mm

Hohmann-Mini
16 cm / 6 1/4"



Freer
JO-21-2160
18.5 cm / 7 1/4"
Sharp / Blunt



Hohmann
JO-21-728
8 mm
22 cm / 8 3/4"



Hohmann
JO-21-729
18 mm
23.5 cm / 9 1/4"



Hohmann
JO-21-730
43 mm
23.5 cm / 9 1/4"



Hohmann
JO-21-731
70 mm
23.5 cm / 9 1/4"



Hohmann
JO-21-732
43 mm
23.5 cm / 9 1/4"

Hohmann
JO-21-733
22 mm
25.5 cm / 10"

Hohmann
JO-21-734
33 mm
29 cm / 11"

Hohmann
JO-21-735
24 mm
27.5 cm / 10 3/4"

Lange-Hohmann
JO-21-736
22 mm
25 cm / 9 3/4"

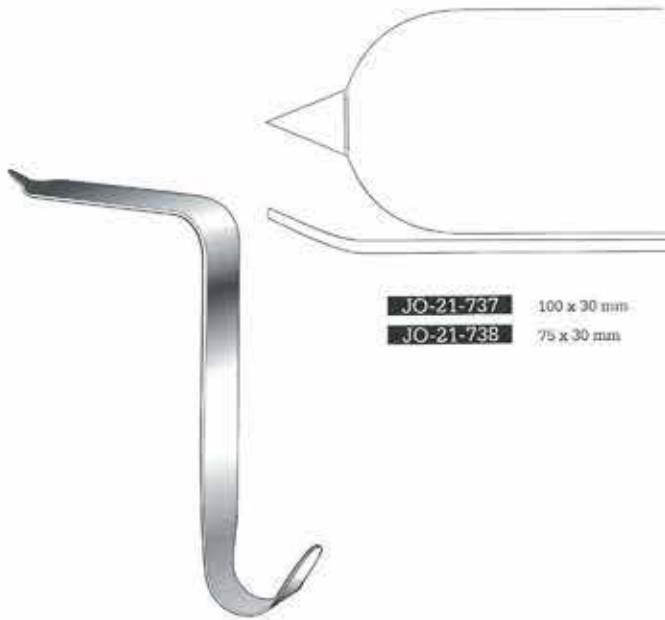

JO-21-737 100 x 30 mm
JO-21-738 75 x 30 mm

Taylor
 16.5 cm / 6 1/2"

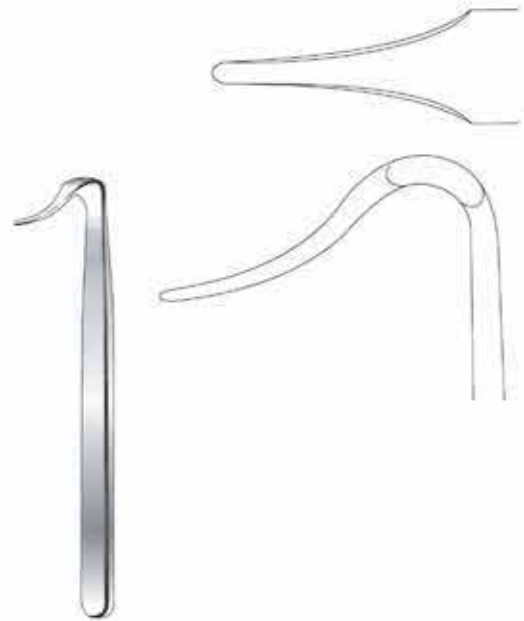

Blount
JO-21-739
 17.5 cm / 7"



Bennett
JO-21-740 Small
JO-21-2045 Large
 24 cm / 9 1/2"



Blount
JO-21-741
 26 cm / 10 1/4"



Blount
JO-21-742
 26 cm / 10 1/4"
 Blount



Smillie



JO-21-743
17 cm / 6 3/4"

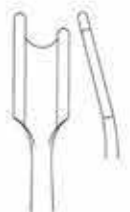

JO-21-744
Curved left

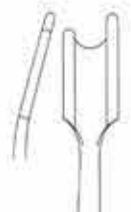

JO-21-745
Curved right



17 cm / 6 3/4"



JO-21-746



JO-21-747



Bircher
19 cm / 7 1/2"



JO-21-748



JO-21-749



Salenius
JO-21-750
22 cm / 8 3/4"



Salenius
JO-21-751
22 cm / 8 3/4"

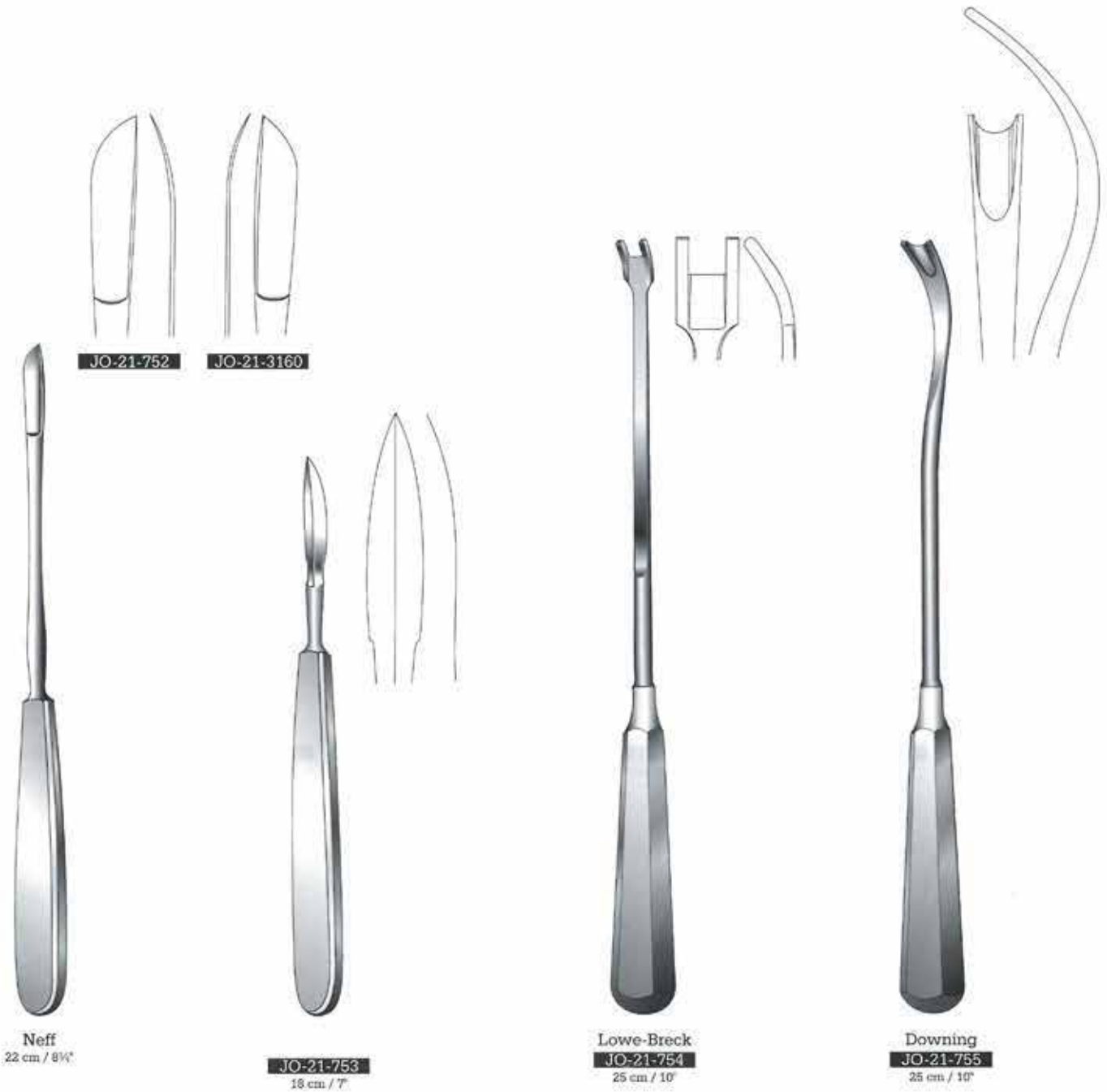



20 cm / 8"



Steinmann
JO-21-758
16 cm / 6 1/4"



Brand



10 cm / 4"



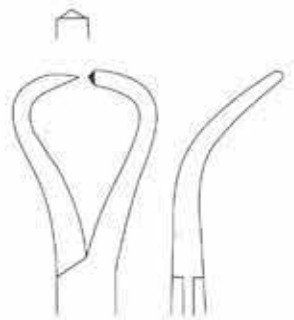
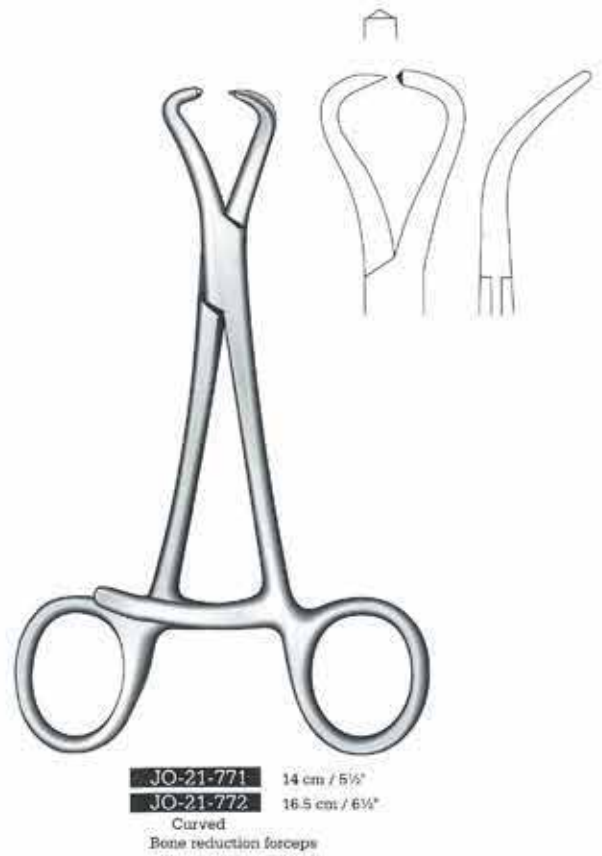
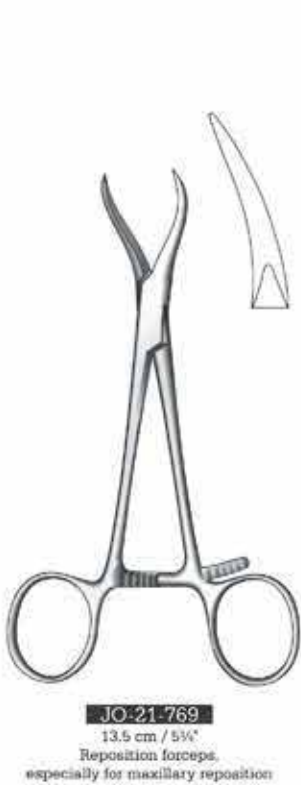

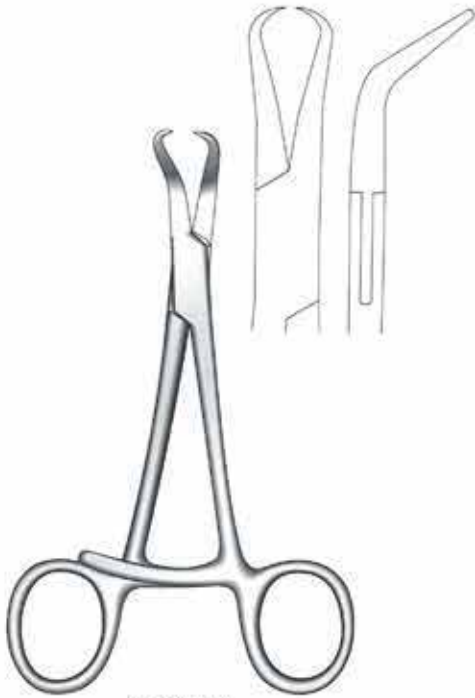

Stagbeetle
JO-21-773
 12 cm / 4 3/4"
 Bone reduction forceps
 Curved, pointed tips

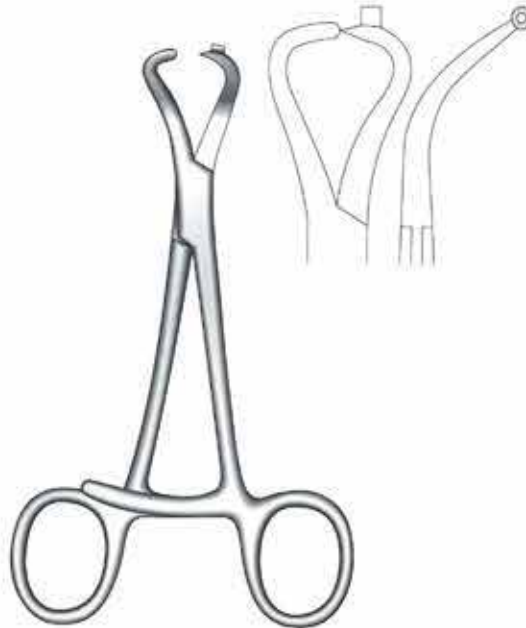

JO-21-774
 13 cm / 5 1/4"
 Bone holding forceps
 Curved, with 1.6 mm k-wire guide



JO-21-1974
 Bone holding forceps

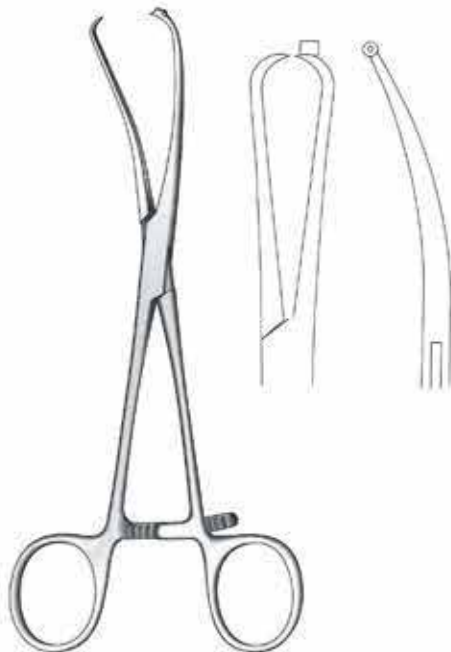

JO-21-775
 17 cm / 6 3/4"
 Bone holding forceps
 Curved, with 1.1 mm k-wire guide

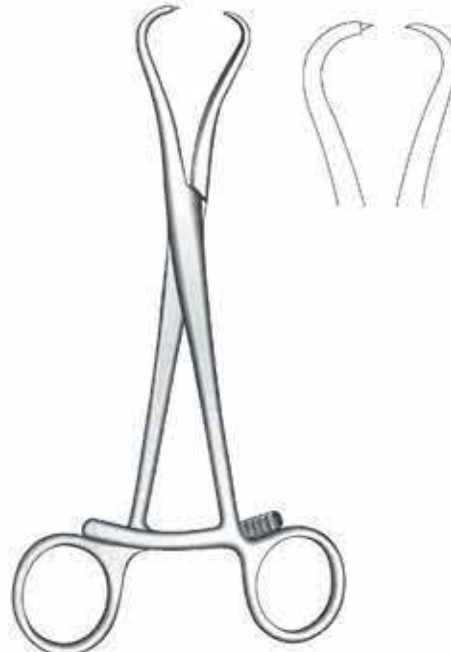

JO-21-2410 15 cm / 6"
JO-21-2412 17.5 cm / 7"
JO-21-2414 20 cm / 8"



JO-21-776
 12.5 cm / 5"

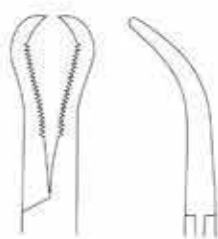

JO-21-777
 14 cm / 5 1/2"

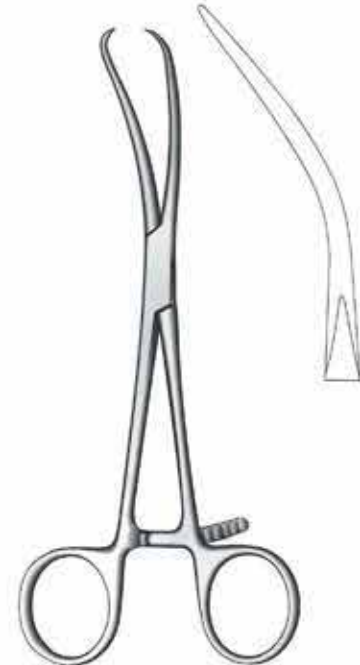

Reill
JO-21-778
 17.5 cm / 7"
 Bone reposition forceps
 curved, pointed tips

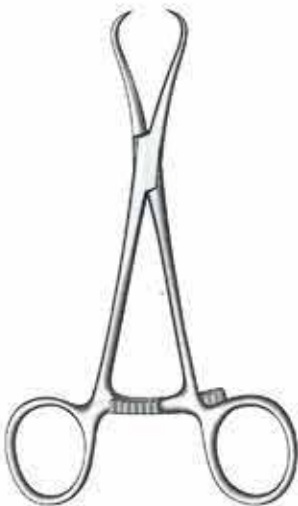

Steinhauser
JO-21-1420
 13 cm / 5"



Steinhauser
JO-21-1425
 13 cm / 5"

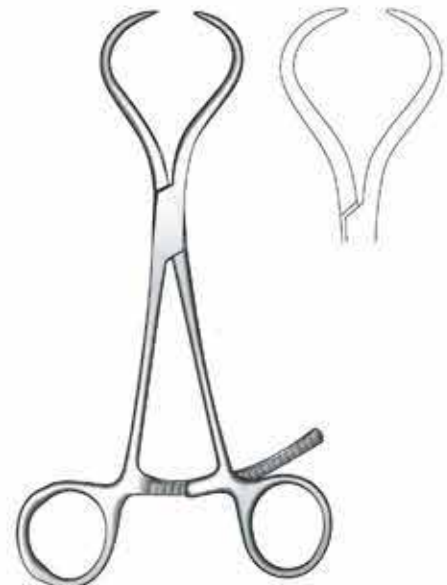

JO-21-1430
 16 cm / 6 1/4"
 Bone fragment forceps

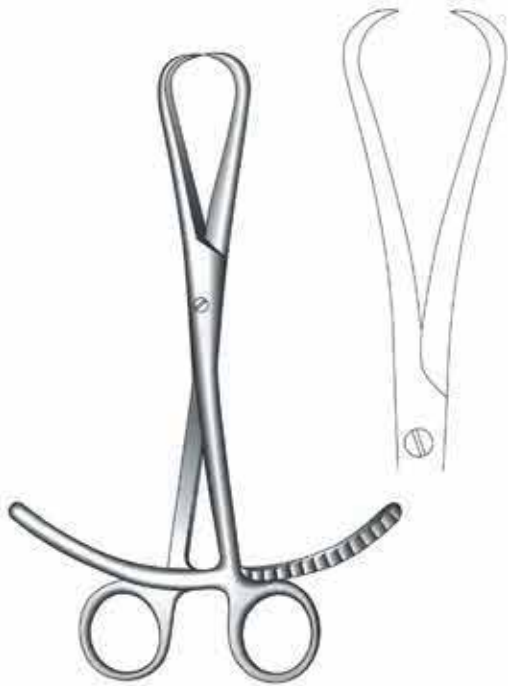

JO-21-1680 15 cm / 6"
JO-21-1681 18 cm / 7"
JO-21-779 20 cm / 8"
JO-21-1682 30 cm / 12"
 Bone reduction forceps



Malleolar
JO-21-780
 21 cm / 8 1/4"
 1 x 1 sharp points.
 Grasping forceps for small bones

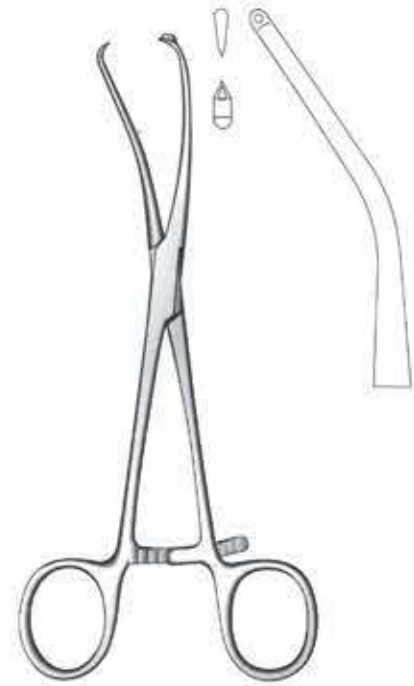

Meyer
JO-21-781
 17 cm / 6 3/4"
 Reposition forceps for gers,
 with drill guide for Kirschner wires
 up to diameter 1.0 mm

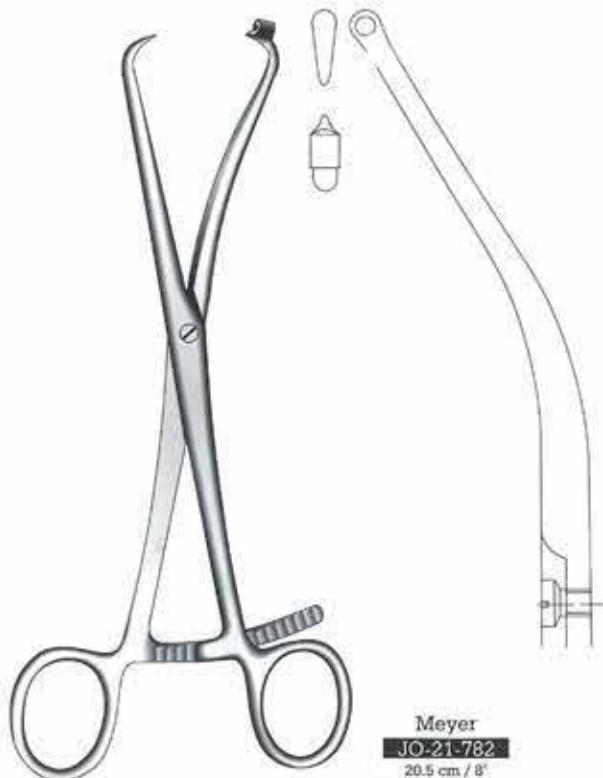

Meyer
JO-21-782
 20.5 cm / 8"
 Reposition forceps
 with drill guide for Kirschner
 wires up to diameter 2.0 mm



JO-21-783
 14 cm / 5 1/2"



Locke
JO-21-784
 15 cm / 6"
 Phalangeal forceps serrated jaws
 1:1 Teeth

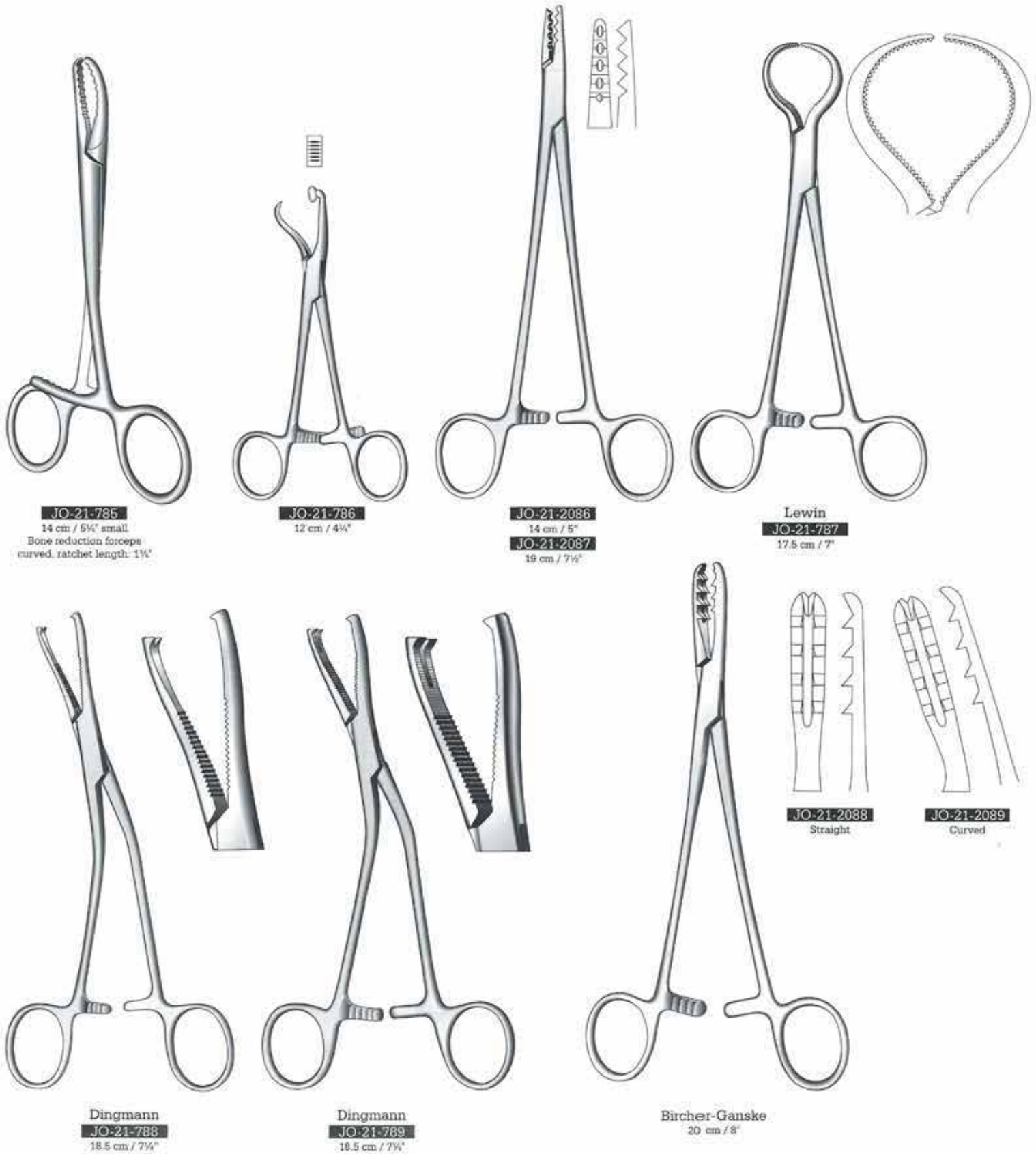

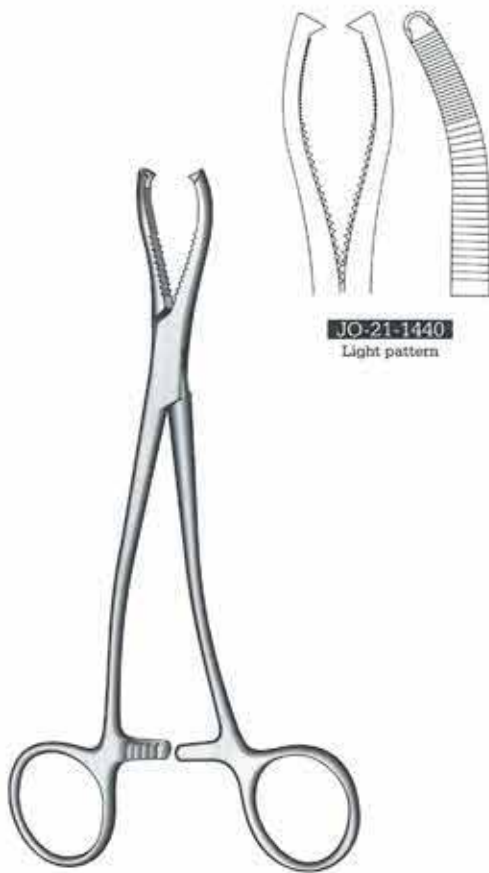

JO-21-1440
Light pattern

Jeter Van Sickers
18 cm / 7"
For sagittal split procedure

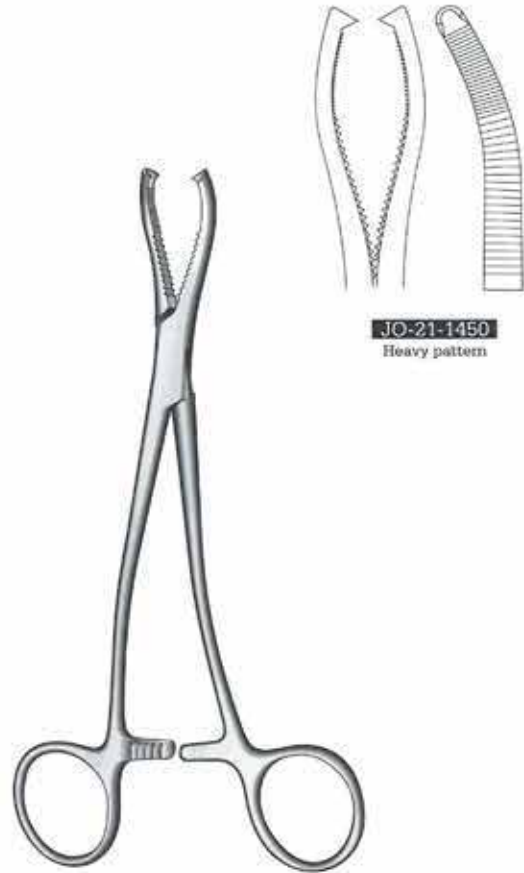

JO-21-1450
Heavy pattern

Jeter Van Sickers
18 cm / 7"
For sagittal split procedure



JO-21-790
 Straight

Requestrum
 20 cm / 8"

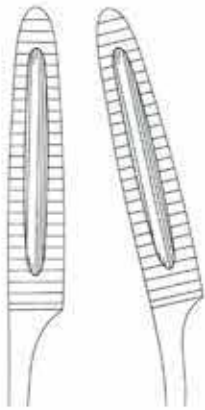

JO-21-2090
 Curved



Van Buren
JO-21-791
 23 cm / 9"



JO-21-792
 20 cm / 8"



Langenbeck
JO-21-793
 21 cm / 8 1/4"



Fergusson
JO-21-794
 21 cm / 8 3/4"

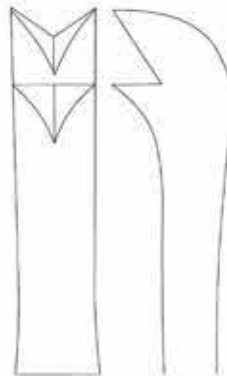

Frosch
JO-21-795
 18 cm / 7"





Semb
JO-21-796
19 cm / 7½"
Without ratchet



Semb
JO-21-797 19 cm / 7½"
Curved sideways
JO-21-2097 20 cm / 8"
Deep teeth with ratchet



Kern
JO-21-798 12 cm / 4¾"
JO-21-799 15 cm / 6"
JO-21-2098 17 cm / 6¾"
JO-21-2099 21 cm / 8¼"
Without ratchet

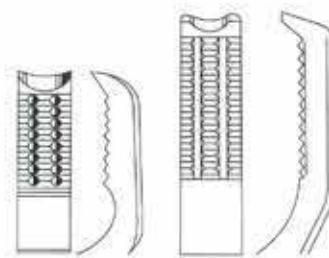

Kern
JO-21-800 12 cm / 4¾"
JO-21-801 15 cm / 6"
JO-21-2503 17 cm / 6¾"
JO-21-2504 21 cm / 8¼"
JO-21-2505 23 cm / 9"
With ratchet

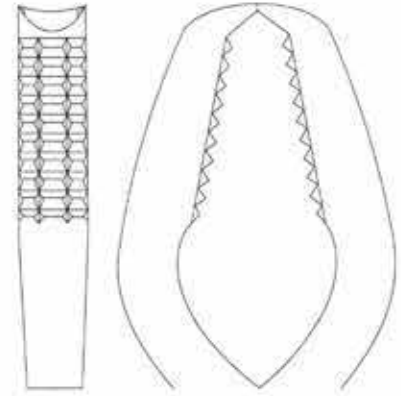
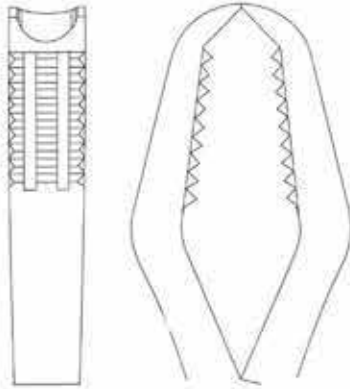

Lane
JO-21-802
 32.5 cm / 13"
 Bone holding forceps
 Light model, without ratchet
JO-21-803
 22.5 cm / 13"
 Light model, with ratchet
JO-21-806
 42.5 cm / 17"
 Without ratchet

Lane
JO-21-2508
 30 cm / 11 3/4"
JO-21-804
 32.5 cm / 13"
 Bone holding forceps
 Standard model, without ratchet
JO-21-805
 32.5 cm / 13"
 Standard model, with ratchet
JO-21-807
 42.5 cm / 17"
 With ratchet



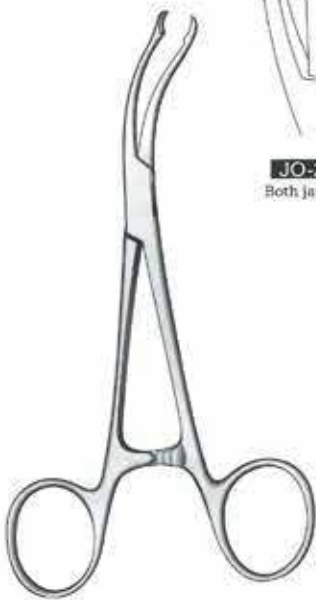

Verbrugge
 18 cm / 6 3/4"



JO-21-1370
 Both jaws serrated



JO-21-1371
 1 jaw serrated
 1 jaw plain



Verbrugge Prehenseur

- JO-21-1375** 18 cm / 7"
 - JO-21-1376** 24 cm / 9 3/4"
 - JO-21-1377** 26 cm / 10 1/4"
 - JO-21-1378** 28 cm / 11"
- Serrated jaws



Verbrugge

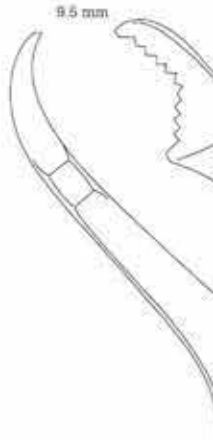

JO-21-811
25 cm / 10"

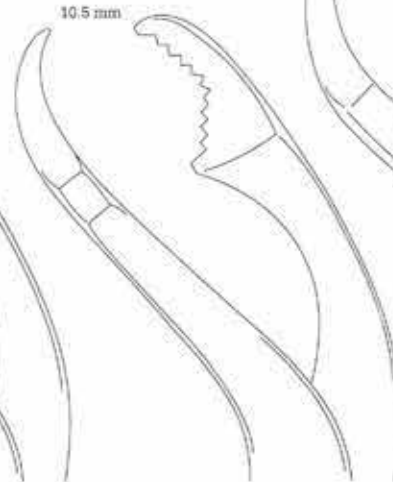

JO-21-812
26 cm / 10 1/4"

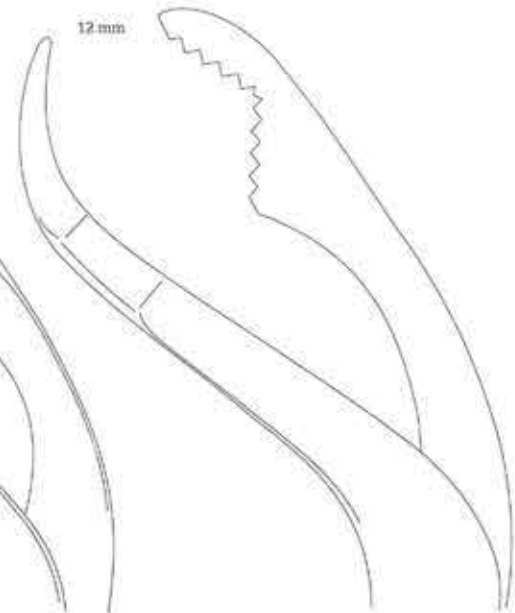

JO-21-813
27 cm / 11"



Verbrugge
17.5 cm / 6 7/8"
JO-21-814
JO-21-2514
Screw joint



Bishop
Adjustable jaws

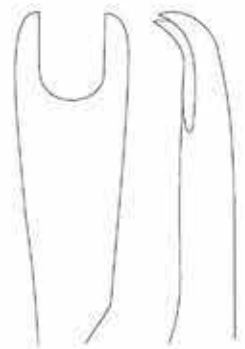

JO-21-815 23 cm / 9"
JO-21-816 32.5 cm / 13"

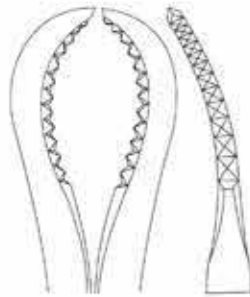

JO-21-817
 16 cm / 6 1/4"

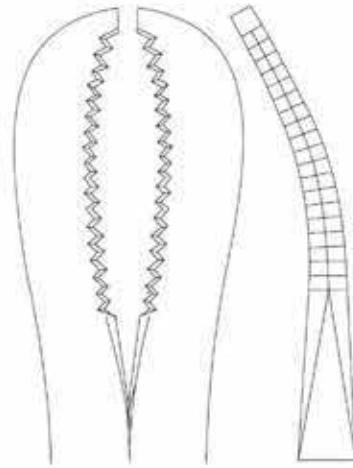

JO-21-818
 24 cm / 9 1/2"



Patella Forceps
JO-21-819
 18 cm / 7"
 2 x 2 sharp teeth
 with speed lock



Ollier
JO-21-1460 19 cm / 7 1/4"
JO-21-1461 22 cm / 8 1/4"
JO-21-1462 27 cm / 10 1/4"

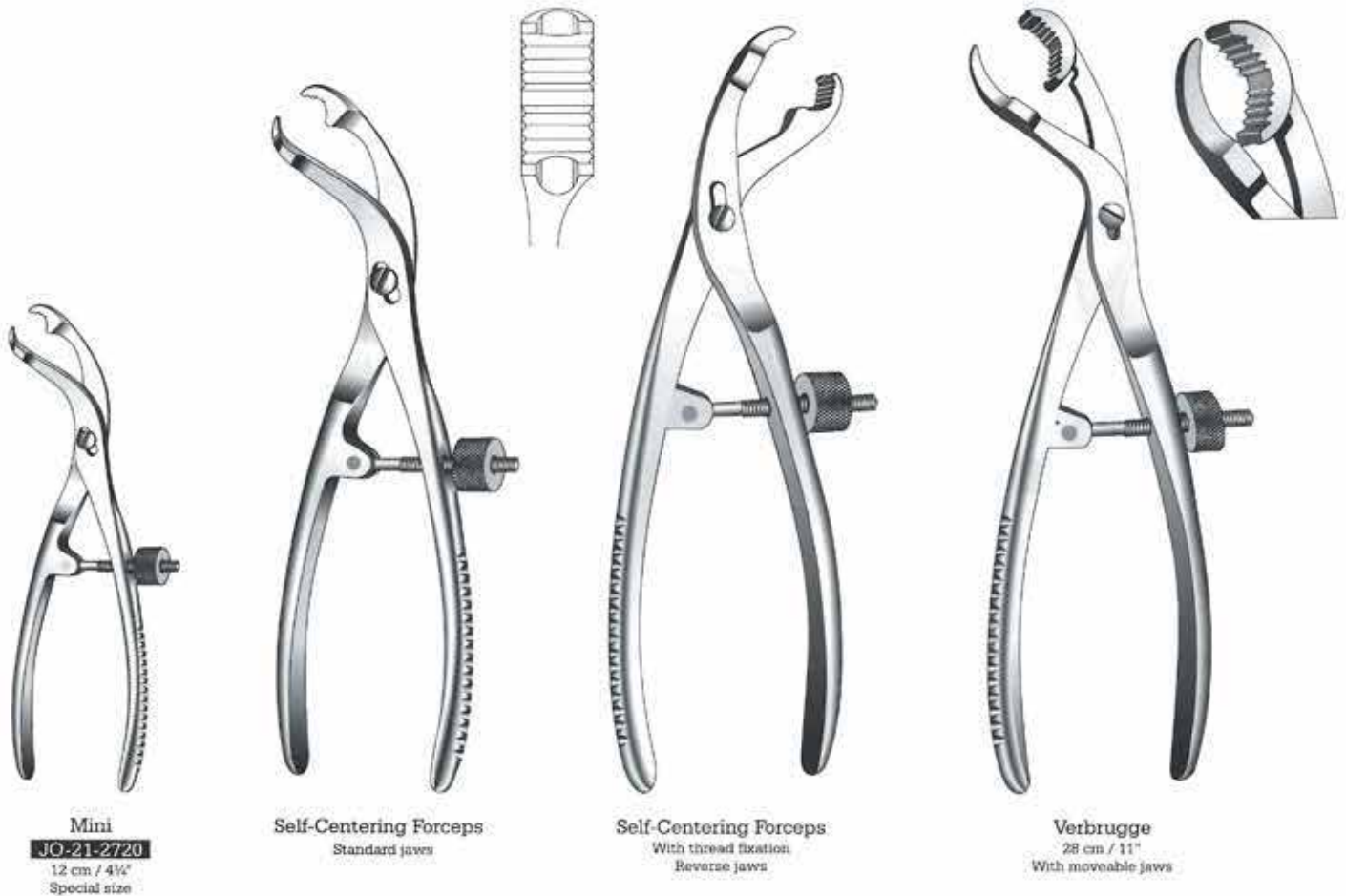
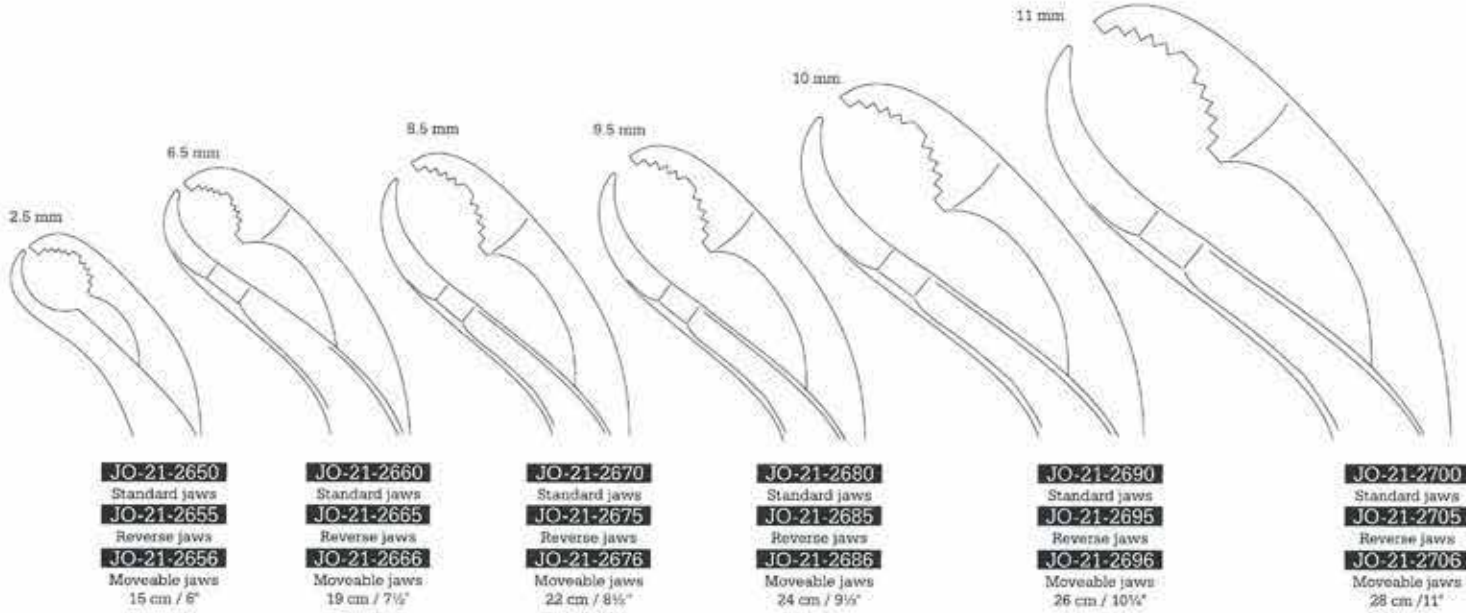

Orthopedic
Bone Holding Forceps
Knochenhaltezaenger
Pinzas para huesos

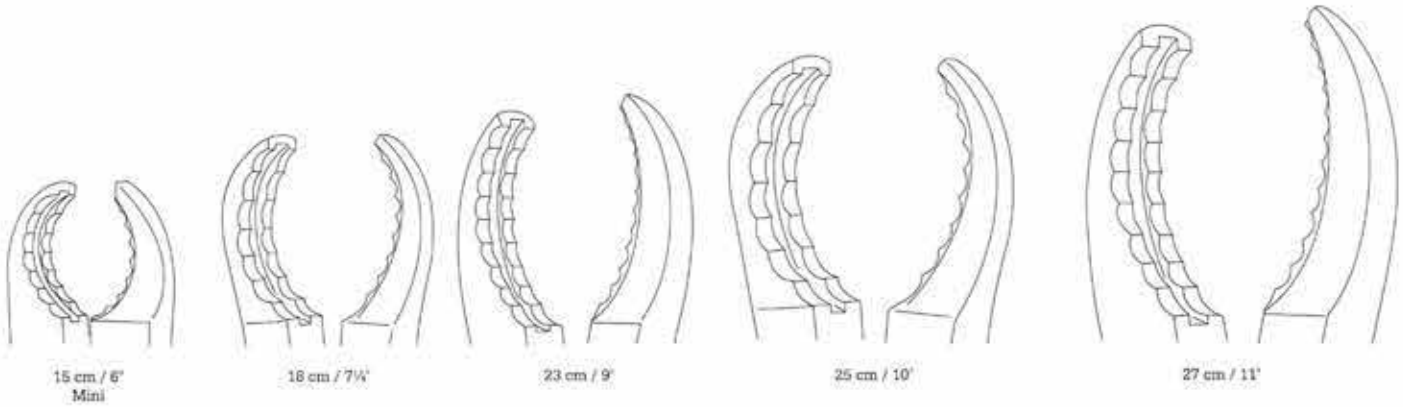

Ulrich
JO-21-2725 13 cm / 5", Mini
JO-21-825 15 cm / 6"
JO-21-826 18 cm / 7 1/4"
JO-21-827 23 cm / 9"
JO-21-828 25 cm / 10"
JO-21-829 27 cm / 11"
Straight



Ulrich
JO-21-2730 13 cm / 5", Mini
JO-21-2731 15 cm / 6"
JO-21-2732 18 cm / 7 1/4"
JO-21-2733 23 cm / 9"
JO-21-2734 25 cm / 10"
JO-21-2735 27 cm / 11"
Angled



Ulrich
JO-21-831
 27 cm / 11"
Self-retaining forceps
angular, moveable jaw

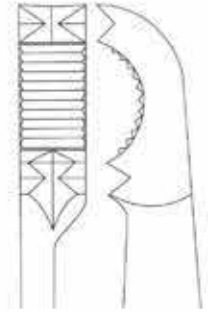
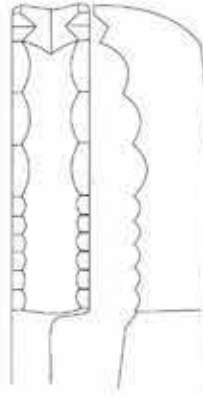
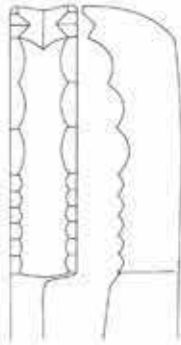

Farabeuf
JO-21-2740 18 cm / 7¹/₂"
JO-21-2743 23 cm / 9"
JO-21-2746 26 cm / 10¹/₄"
 Adjustable



Farabeuf Lambotte
JO-21-2750 19 cm / 7¹/₂"
JO-21-2752 23 cm / 9"
JO-21-2756 26 cm / 10¹/₄"
 Adjustable



Tuffier
JO-21-835
 27 cm / 10⁵/₈"
 Adjustable

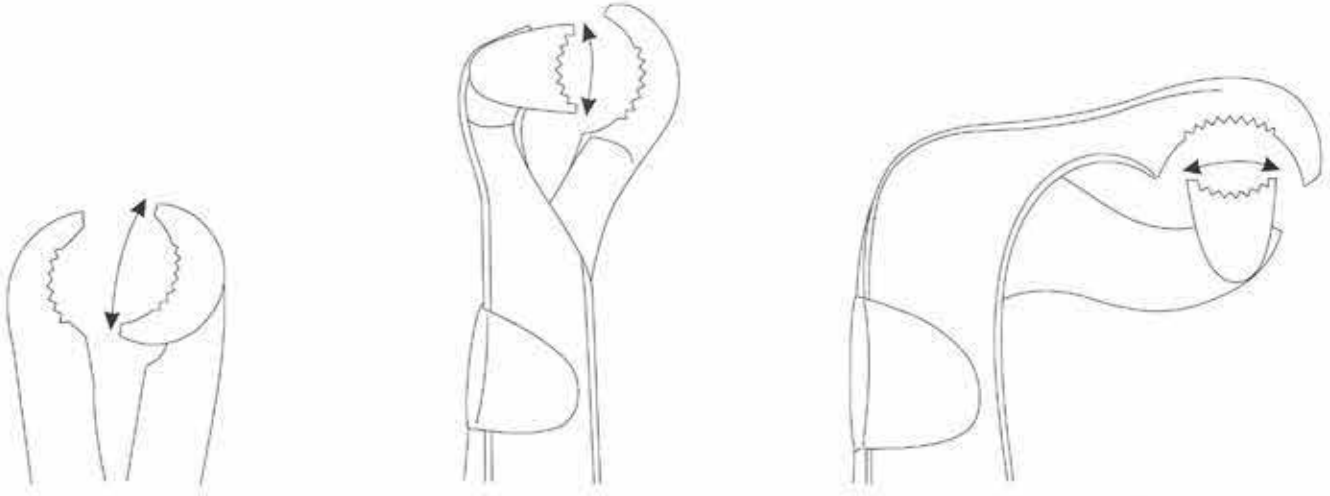

Lambotte
JO-21-836 22 cm / 8½"
JO-21-837 27 cm / 10½"
JO-21-838 30 cm / 12"
 Adjustable



Lambotte
JO-21-839 22 cm / 8½"
JO-21-840 28 cm / 10½"
JO-21-841 33 cm / 13"



Lambotte
JO-21-842 19 cm / 7½"
JO-21-843 23 cm / 9"
JO-21-844 28 cm / 10½"

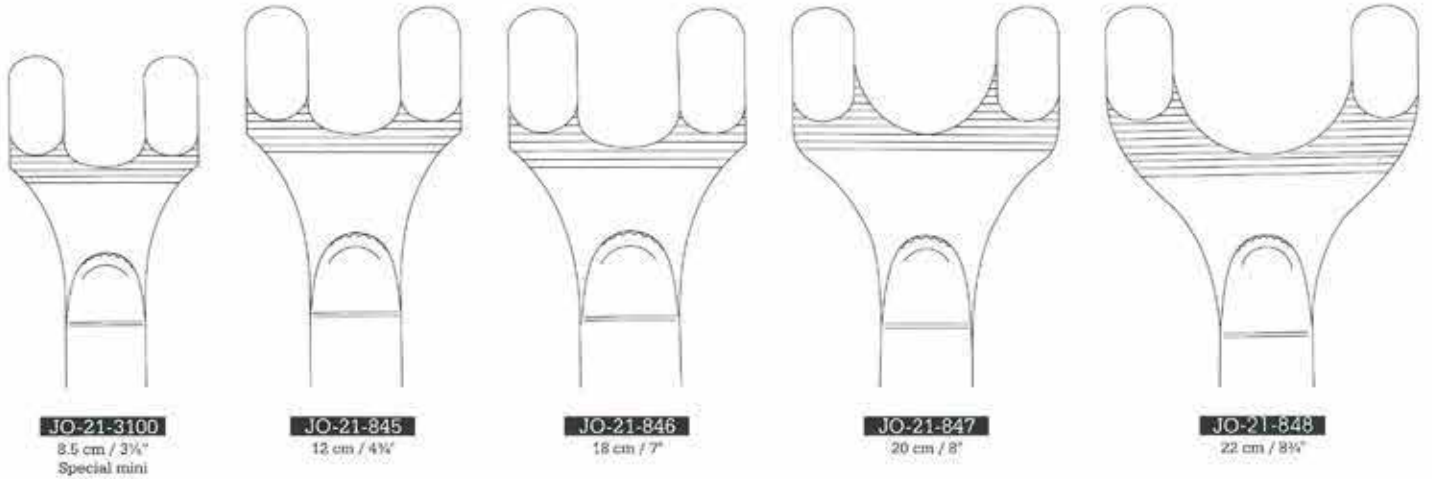

Gerster - Lowmann
1 x 2 jaws

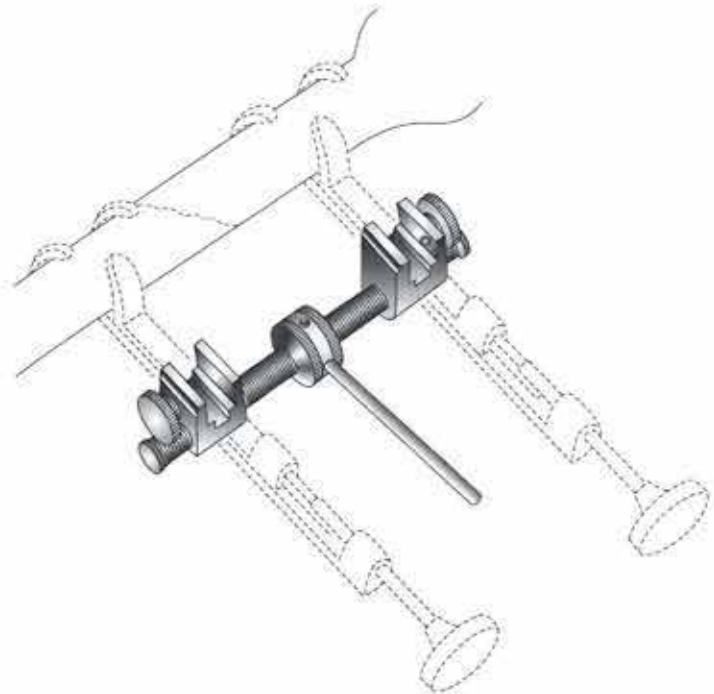
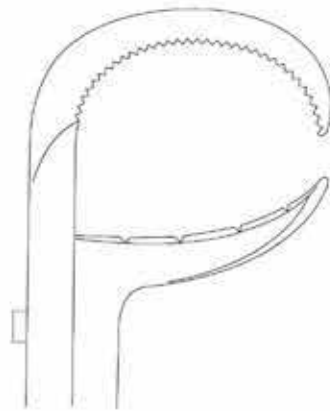

Gerster
JO-21-849



JO-21-850
 12 cm / 4 3/4"

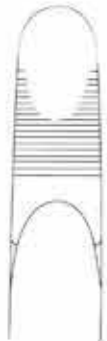

JO-21-851
 18 cm / 7 1/4"

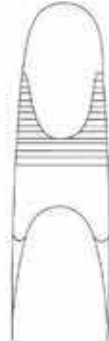

JO-21-852
 20 cm / 8"

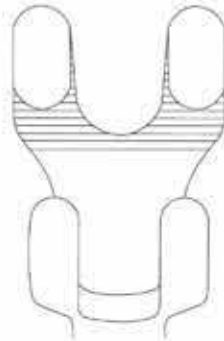

JO-21-853
 18.5 cm / 7 3/8"

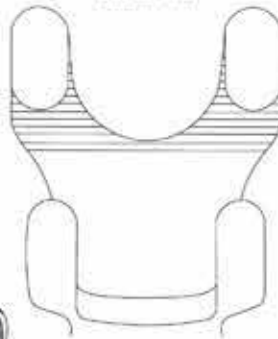

JO-21-854
 20 cm / 8"



Lowmann
 Bone clamp
 1 x 1 jaws



Lowmann
 Bone clamp
 2 x 2 jaws



Lowman Høglund
JO-21-1700 12 cm / 4 3/4"
JO-21-1701 18 cm / 7 1/4"
JO-21-1702 20 cm / 8"
 Moveable jaw



JO-21-2760 19 cm / 7½"
JO-21-2761 23 cm / 9"
JO-21-2762 25 cm / 10"



JO-21-2765 23 cm / 9"
JO-21-2766 25 cm / 10"



JO-21-2770
40 cm / 16"



JO-21-2775
40 cm / 16"



JO-21-2780
40 cm / 16"

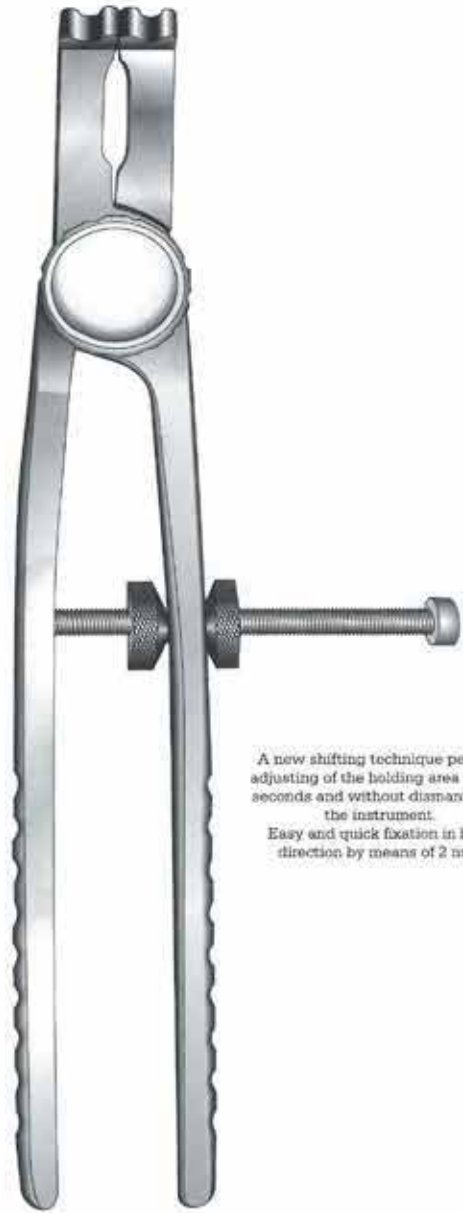

JO-21-2785
Reposition forceps

A new shifting technique permits adjusting of the holding area within seconds and without dismantling the instrument.
Easy and quick fixation in both direction by means of 2 nuts

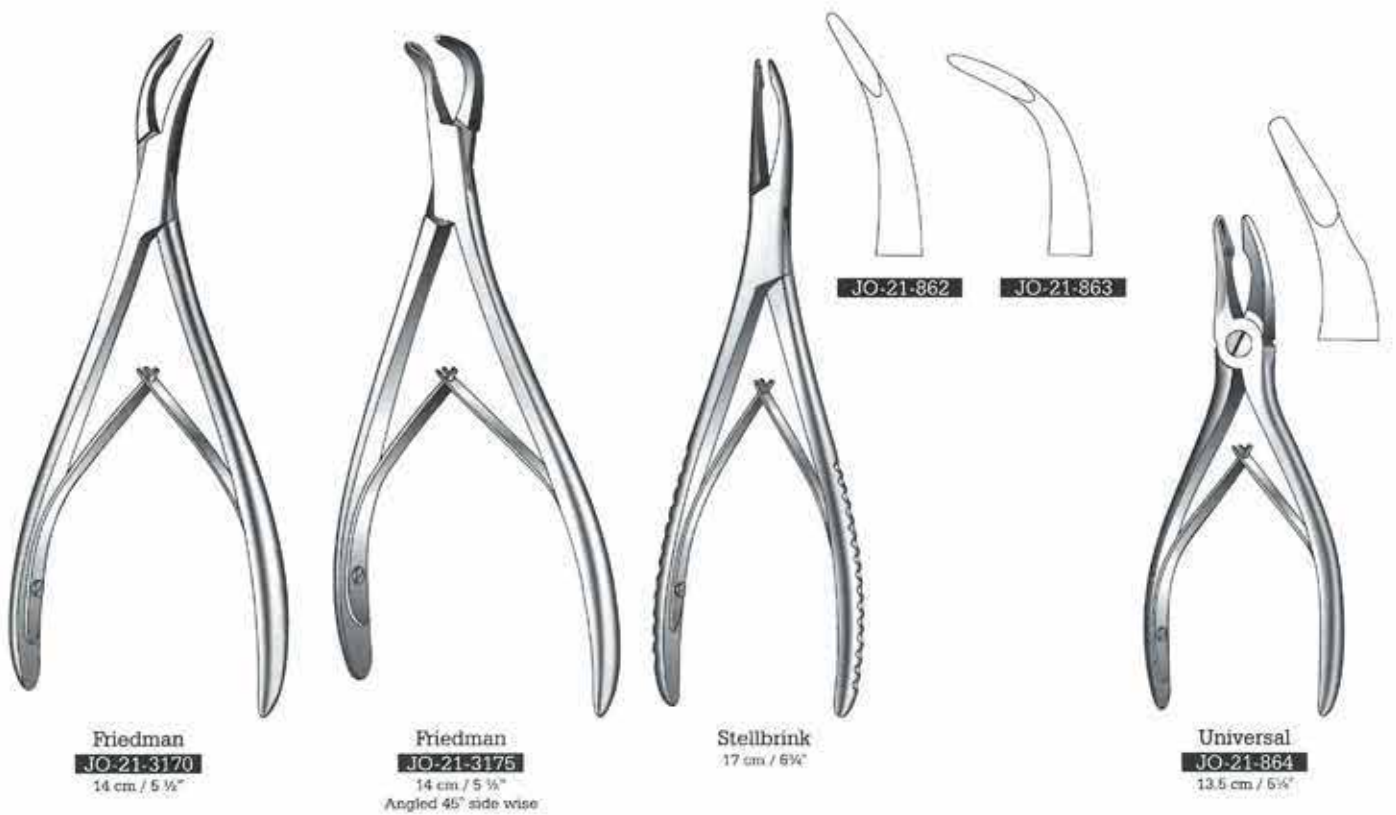
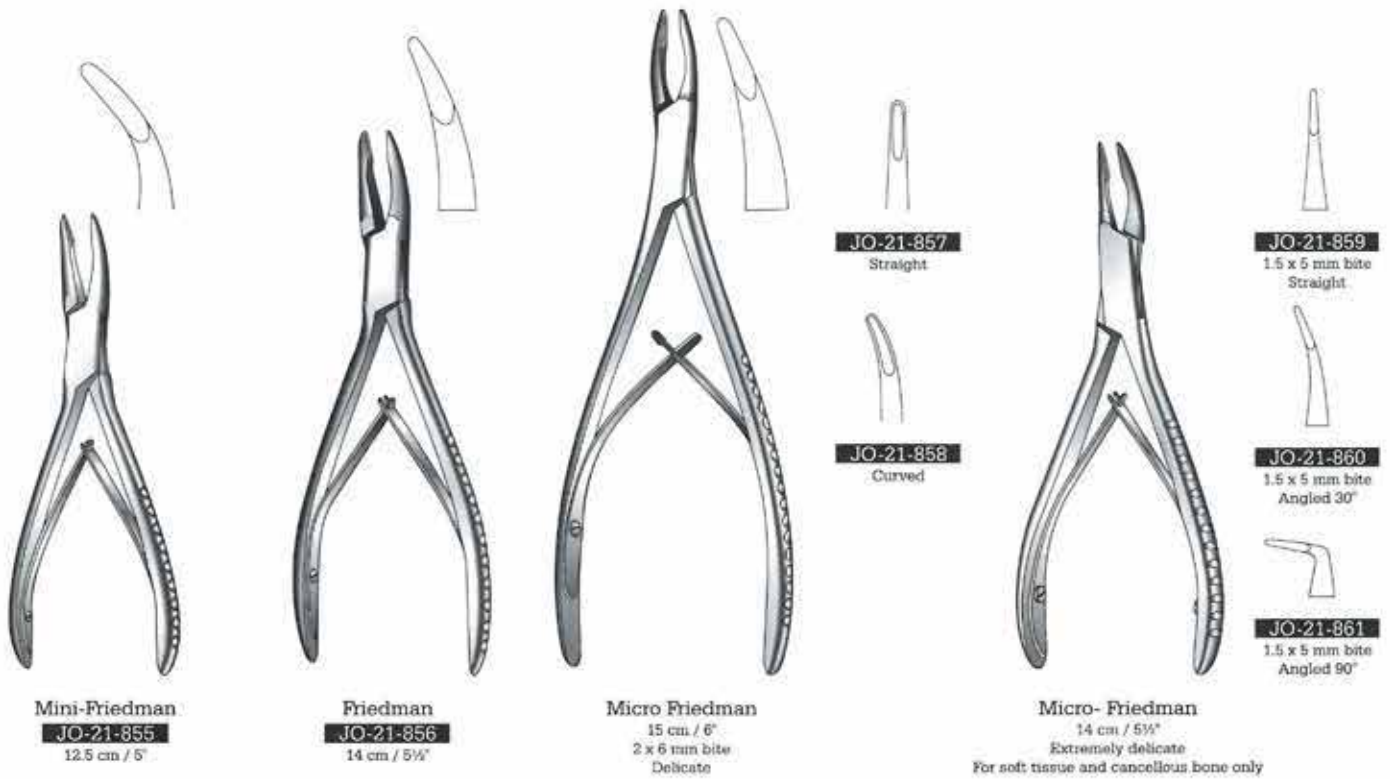





Jansen
 18 cm / 7"



JO-21-870



JO-21-871



JO-21-872



Jansen
 18 cm / 7"



JO-21-873



JO-21-874



Marchac
JO-21-1710
 18 cm / 7"



Blumenthal
 15 cm / 6"



JO-21-875



JO-21-876



JO-21-877



Luer
 15 cm / 6"



JO-21-878



JO-21-879



JO-21-880



Luer
17 cm / 6 3/4"



JO-21-881



JO-21-882



Hakansson
JO-21-883
17 cm / 6 3/4"



Curved to side



Alexander
JO-21-884
14 cm / 5 1/2"



Jansen
JO-21-885
19 cm / 7 1/2"



Beyer
JO-21-886
18 cm / 7"



Olivecrona
JO-21-887
20.5 cm / 8"







Lempert
2.5 mm bite



JO-21-1715
16 cm / 6 1/4"
JO-21-894
19 cm / 7 1/2"
Straight



JO-21-1716
16 cm / 6 1/4"
JO-21-895
19 cm / 7 1/2"
Curved



Juers-Lempert
Straight jaws on curved handles, delicate, 2.5 mm bite



JO-21-1725
16 cm / 6 1/4"
JO-21-1726
18.5 cm / 7 1/4"
Straight



JO-21-1727
16 cm / 6 1/4"
JO-21-1728
18.5 cm / 7 1/4"
Curved



Bohler
15 cm / 6"



JO-21-896
2 mm tip
JO-21-1730
3 mm tip
JO-21-1732
4 mm tip



JO-21-897
2 mm tip
JO-21-1731
3 mm tip
JO-21-1733
4 mm tip



Zaufal-Jansen
JO-21-898
18 cm / 7"



Mayfield
JO-21-899
17 cm / 6 3/4"



JO-21-2790
Straight



JO-21-2791
Curved



Beyer
18 cm / 7"



Ruskin
Delicate



JO-21-2800 2 mm
JO-21-2801 3 mm
JO-21-2802 4 mm
15 cm / 6"
JO-21-2810 2 mm
JO-21-2811 3 mm
JO-21-2812 4 mm
JO-21-2813 6 mm
JO-21-2814 8 mm
17.5 cm / 7"

JO-21-2820 2 mm
JO-21-2821 3 mm
JO-21-2822 4 mm
JO-21-2823 6 mm
JO-21-2824 8 mm
20 cm / 8"
Straight



JO-21-2830 2 mm
JO-21-2831 3 mm
JO-21-2832 4 mm
15 cm / 6"
JO-21-2840 2 mm
JO-21-2841 3 mm
JO-21-2842 4 mm
JO-21-2843 6 mm
JO-21-2844 8 mm
17.5 cm / 7"

JO-21-2850 2 mm
JO-21-2851 3 mm
JO-21-2852 4 mm
JO-21-2853 6 mm
JO-21-2854 8 mm
20 cm / 8"
Curved



Ruskin
JO-21-904
23 cm / 9"



JO-21-905 **JO-21-906** **JO-21-907**
Straight Curved Full curved

Smith-Peterson
24 cm / 9 1/2"
3 x 15 mm bite
Laminectomy rongeur



Marquard
JO-21-908
20 cm / 8"

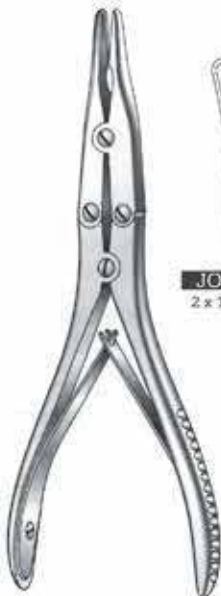

JO-21-909 **JO-21-910**
2 x 13 mm bite 3 x 13 mm bite

Kleinert-Kutz
15 cm / 6"
Synovectomy rongeur
Slight curve, delicate



JO-21-911
15 cm / 6"
3 x 8 mm bite
Full curved
Delicate



Kleinert-Kutz
JO-21-912
15 cm / 6"
2 x 10 mm bite
Synovectomy rongeur
Curved on side
Delicate

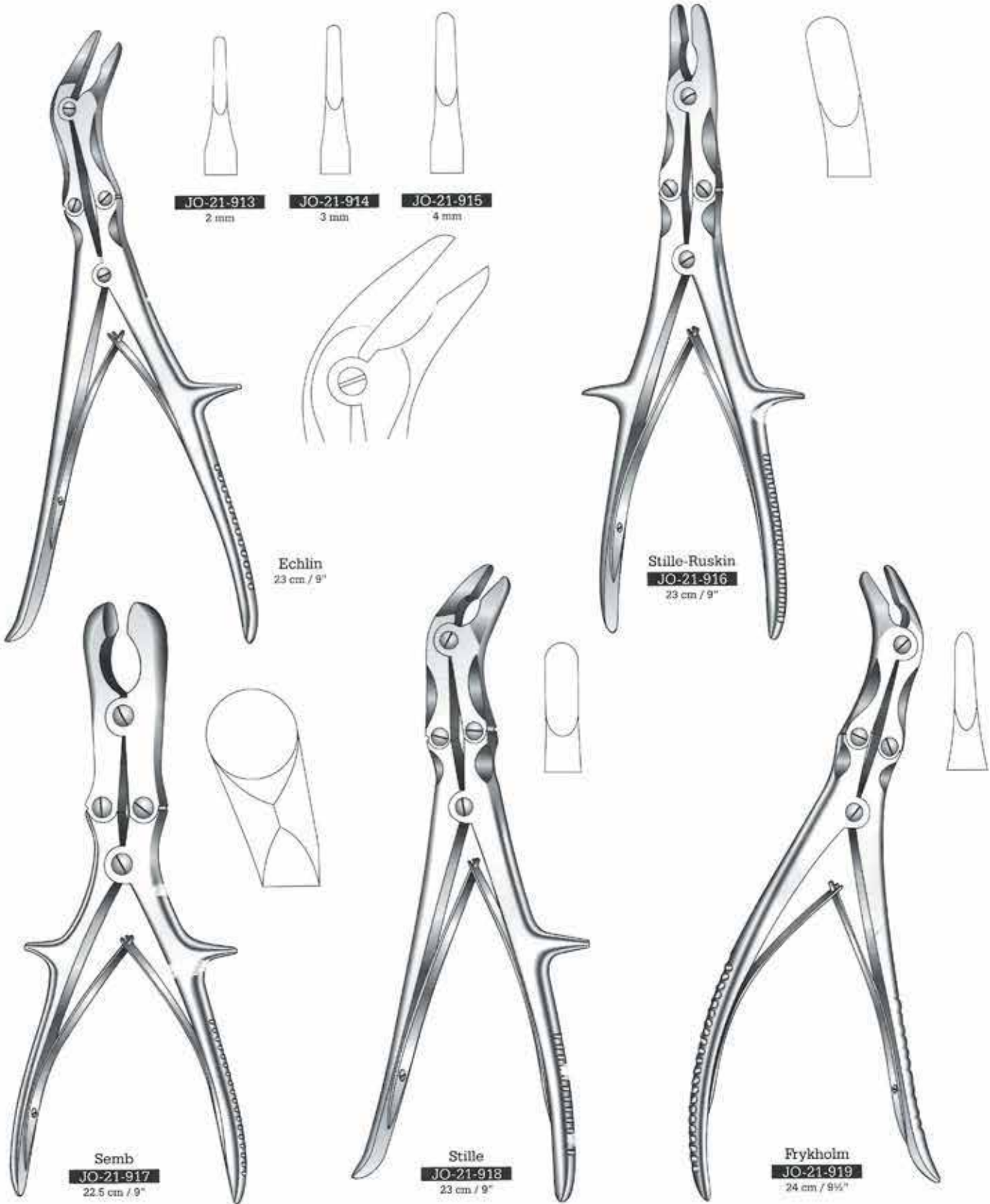



Leksell-Stille
24 cm / 9½"
Curved 15°



Leksell
23 cm / 9"
Curved 50°



JO-21-920
3 x 16 mm bite



JO-21-921
4 x 16 mm bite



JO-21-922
5 x 16 mm bite



JO-21-923
6 x 16 mm bite



JO-21-924
7 x 16 mm bite



JO-21-925
8 x 16 mm bite



JO-21-926
3 x 13 mm bite



JO-21-927
4 x 13 mm bite



JO-21-928
5 x 13 mm bite



JO-21-929
6 x 13 mm bite



JO-21-930
7 x 13 mm bite



JO-21-931
8 x 13 mm bite

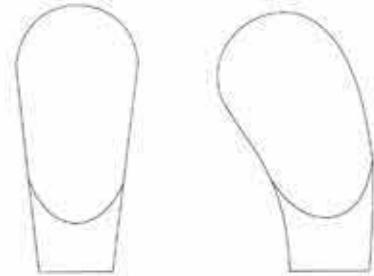

JO-21-934	23 cm / 9"	JO-21-936
JO-21-935	27 cm / 10 3/4"	JO-21-937

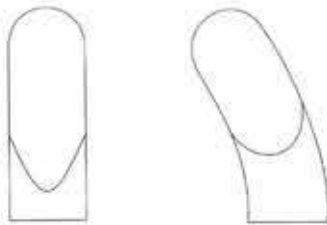

JO-21-2870	4 mm	JO-21-2890
JO-21-2872	6 mm	JO-21-2892
JO-21-2874	8 mm	JO-21-2894
JO-21-2876	10 mm	JO-21-2896
JO-21-2878	12 mm	JO-21-2898



Stille-Luer
 22 cm / 8 1/2"
 8 mm



Stille-Luer



JO-21-938



JO-21-939



Sauerbruch
 30 cm / 12"



JO-21-2910
 3 mm



JO-21-2912
 5 mm



JO-21-2914
 6 mm



JO-21-2916
 8 mm



Syvert
 36 cm / 14 1/2"



JO-21-2920
 3 mm



JO-21-2922
 5 mm



JO-21-2924
 6 mm



JO-21-2926
 8 mm



Dale

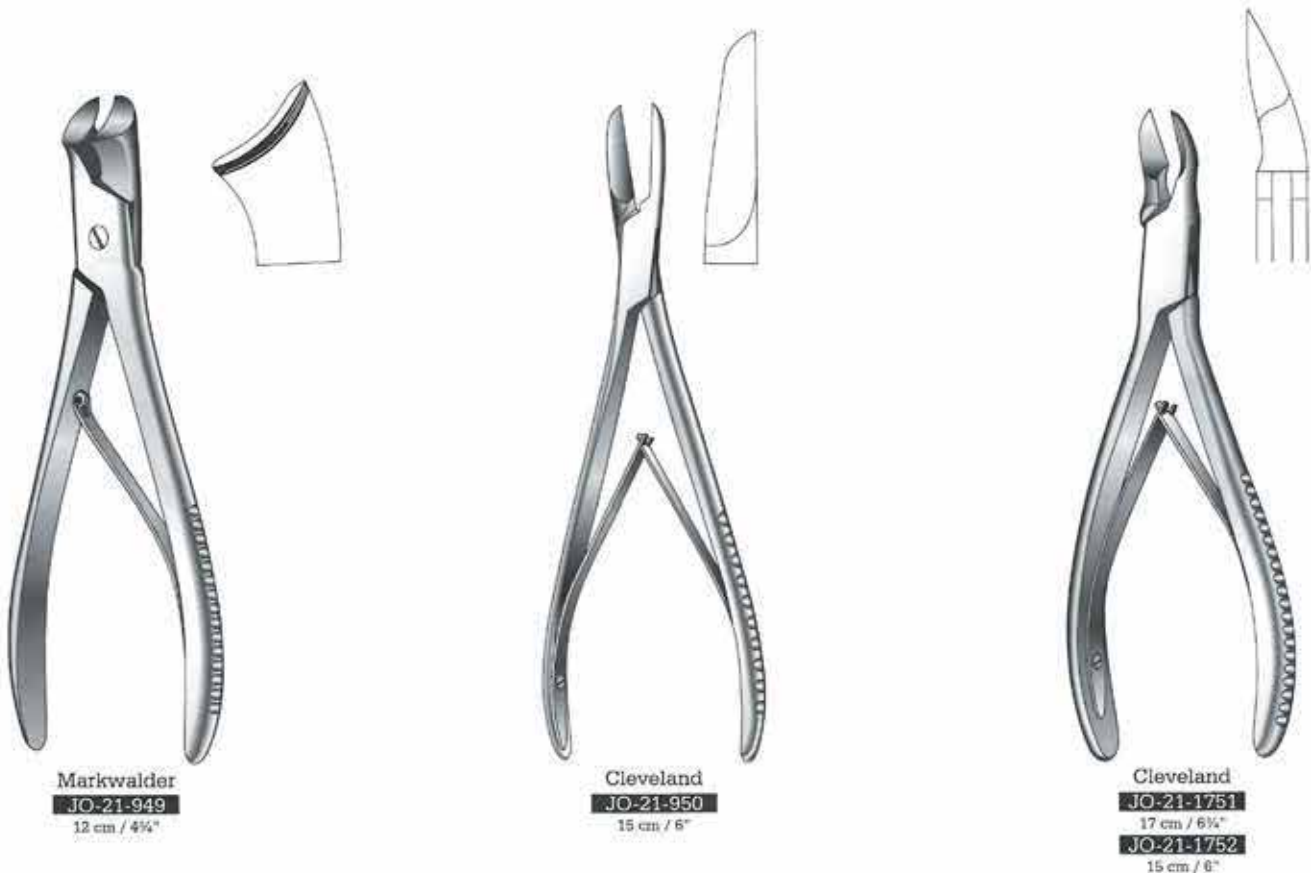
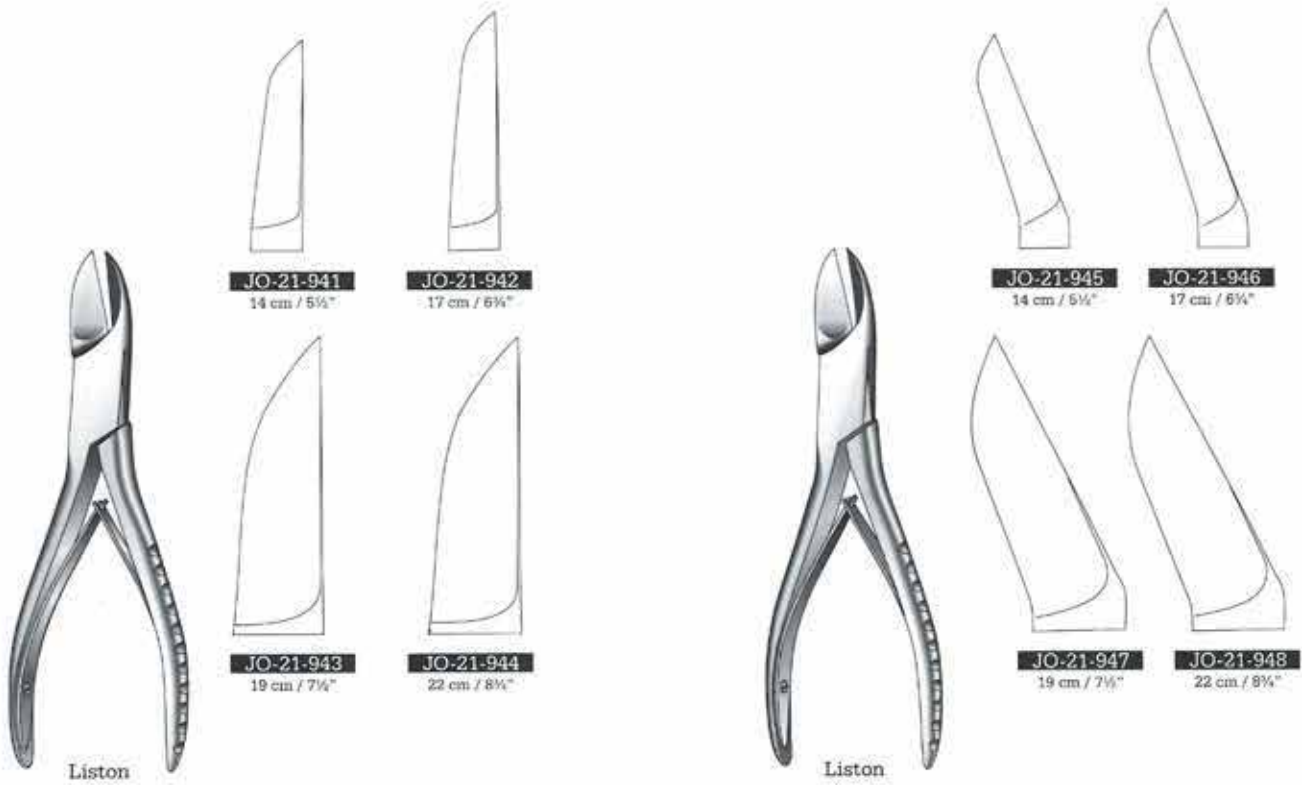



Stamm
JO-21-952
 15 cm / 6"



Kazanjan
JO-21-953
 18.5 cm / 7 1/4"



Tessier
JO-21-1755
 23.5 cm / 8"
 Slim pattern



Markwalder
JO-21-954
 20 cm / 8"



Cleveland
 16 cm / 5 1/4"



JO-21-955 **JO-21-956**



Bohler
JO-21-957
 15 cm / 5 3/4"



Bohler
JO-21-958
 14.5 cm / 5 3/8"



Velpeau
JO-21-1760
 24 cm / 9 1/2"



Bohler
JO-21-959
14.5 cm / 5 3/4"



JO-21-960
17 cm / 6 3/4"



Mc Indoe
JO-21-961
17.5 cm / 7"



Ruskin-Liston
18.5 cm / 7 1/4"

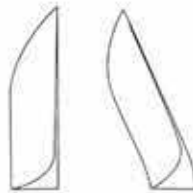

JO-21-962 **JO-21-963**

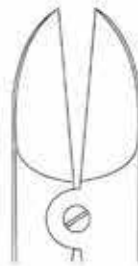

Liston
JO-21-964
24 cm / 9 1/2"

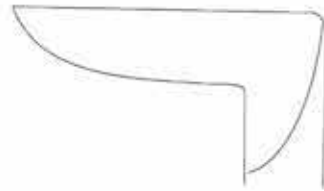

Stille-Liston
JO-21-965
27 cm / 10 1/4"



Stille-Liston
JO-21-966
27 cm / 10 1/4"



Stille-Liston
JO-21-967
27 cm / 10 1/4"

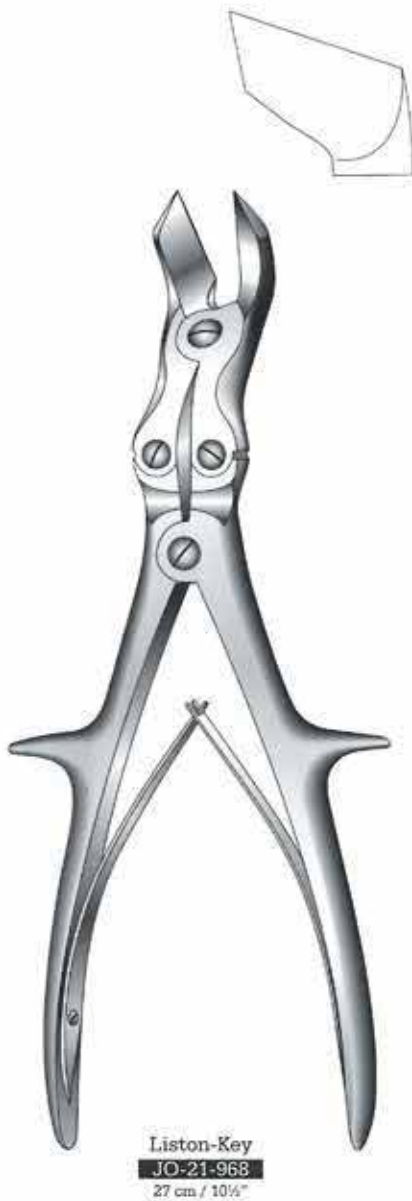

Instruments with Tungsten Carbide Inserts

TC GOLD



TC Gold
JT-21-1030
 15.5 cm / 6"



Corwin
 TC Gold
JT-21-1031
 16 cm / 6 1/4"



TC Gold
JT-21-979
 16 cm / 6"



TC Gold
JT-21-971
 20 cm / 8"



TC Gold
JT-21-972
 18.5 cm / 7 1/4"
JT-21-1220
 20 cm / 8"



TC Gold
JT-21-1210
 Jet wire twister

Orthopedic

Wire Tightening Pliers, Flat Nose Pliers
Drahtspannierzangen, Flachzangen
Tensor cierra-hilo, Alicates de pico plano



JT-21-973
17 cm / 6 3/4"
Holding forceps for cerclage wire, with lateral jaws to avoid wire slipping off

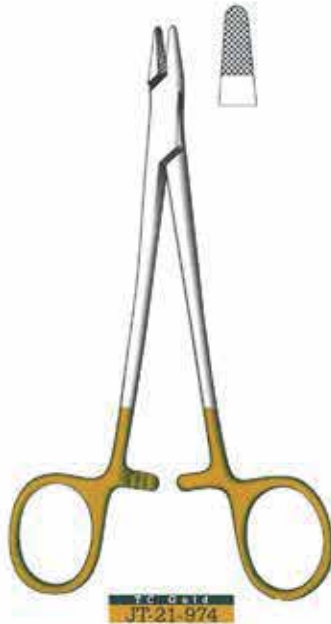

JT-21-974
15 cm / 6"
Wire tightening pliers
ligature pliers



Baumgartner
JT-21-975
20 cm / 8"
Wire twister, ligature forceps

Instruments with Tungsten Carbide Inserts
TC GOLD



18 cm / 7"
Parallel grip

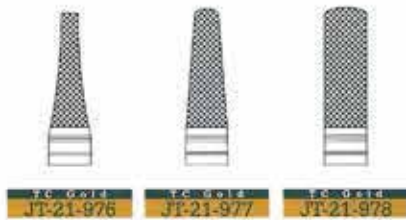

18 cm / 7"
Parallel grip

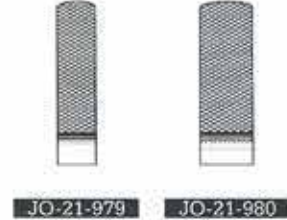



JO-21-981
 16 cm / 6 1/4"
 Heavy pattern



JO-21-982
 15 cm / 6"
 For bending & cutting



JO-21-983
 16.5 cm / 6 1/2"

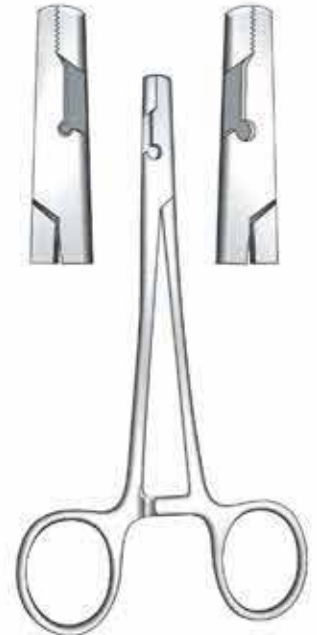

JO-21-1132
 Wire twister / Shear cutter
 cuts wire up to 18g, twisted double



17 cm / 6 3/4"



JO-21-984

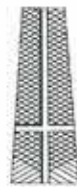

JO-21-985
 With crosswise groove



Hakstock
JO-21-986
 16 cm / 6 1/4"
 With longitudinal groove



JO-21-987
 14 cm / 5 1/2"



Orthopedic

F1at Nose & wire Twisting Pliers

Flachzangen, Draht-Kneifzangen

Alicates planos, Alicates para cortar alambre

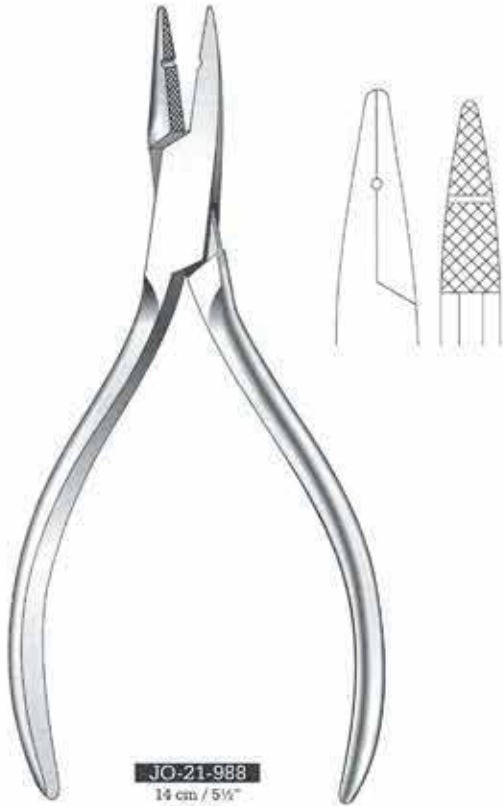

JO-21-988
14 cm / 5 1/2"
Delicate

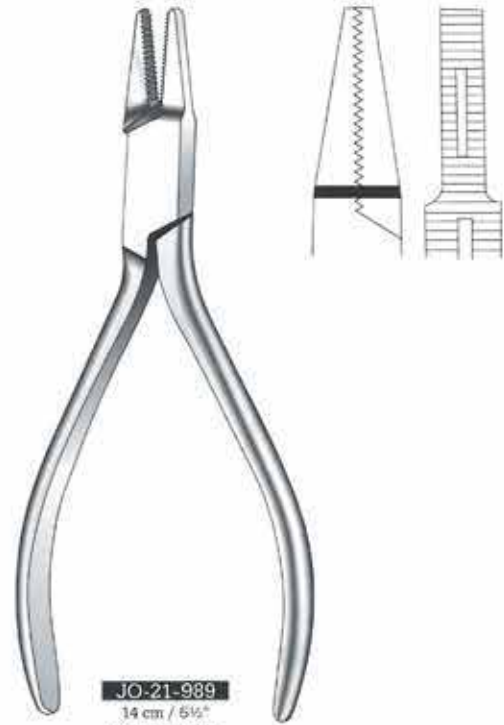

JO-21-989
14 cm / 5 1/2"
Flat nose plier
Broad

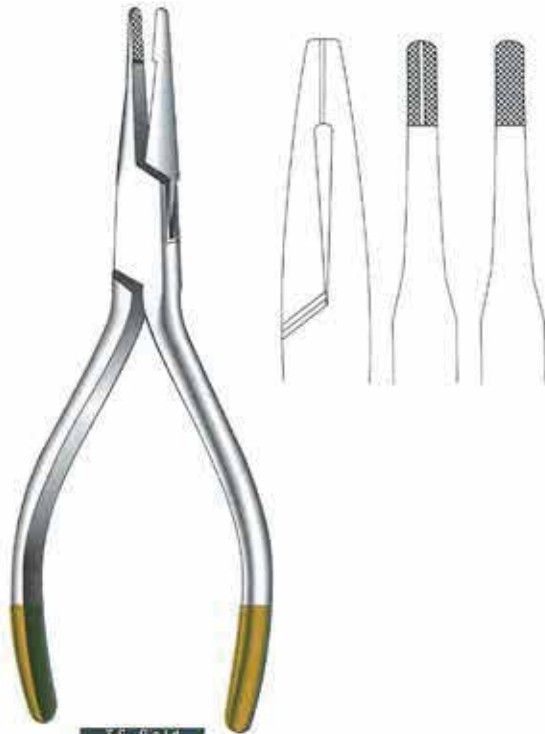

JT-21-990
14 cm / 5 1/2"
4 mm tip
Pin pulling plier

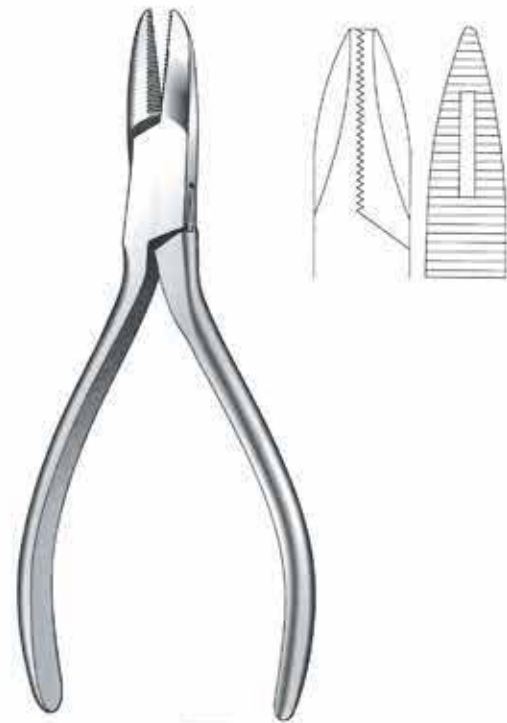

JO-21-991
14 cm / 5 1/2"
2 mm tip
Needle nose plier

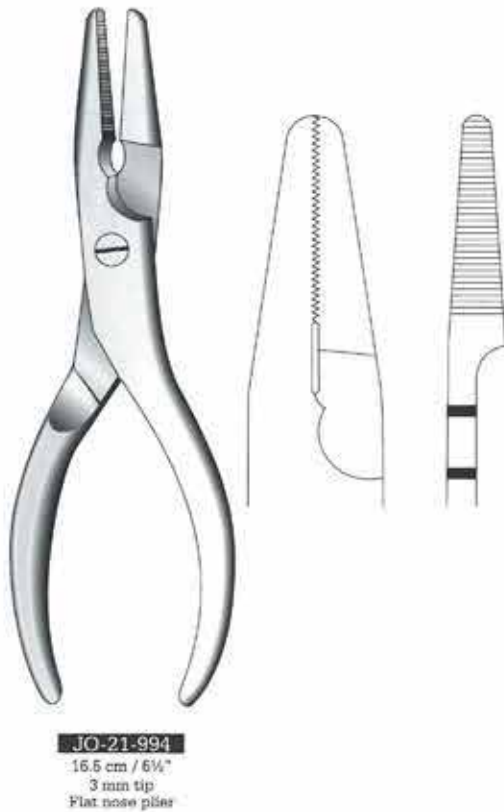
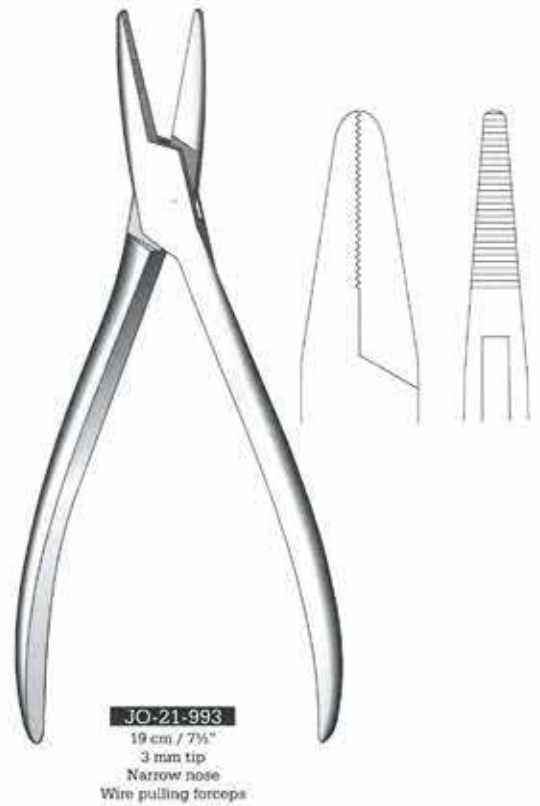

Orthopedic

Wire Tighteners, Drill Chucks and Wire Twisters

Draht Spann, spannfutter und Drahtzwirbel

Terisores cirra-hilo, mandril de sujecion y Tercer de alambre



Jacobs
JO-21-3200 Small
JO-21-3205 Large
 Stainless steel



JO-21-3210
 Key for Jacobs chuck
 Stainless steel



SV-2603-00
 Wire tightener



JO-21-3215 Small
JO-21-3220 Large
 Chrome plated
JO-21-3225 Small
JO-21-3230 Large
 Stainless steel



JO-21-3235
 Key for chuck



JO-21-1127
 18 cm / 7"
 Small cerclage wire twister
 anodized aluminum handle



JO-21-1128
 Large
 anodized aluminum handle



JO-21-1129



JO-21-1130
 Wire twister small
 Stainless steel



JO-21-1131
 18 cm / 7"
 Large cerclage wire twister
 anodized aluminum handle
 Stainless steel tip



JO-21-996
 20 cm / 8"
 Slip joint plier
 10 mm tip
 Maximum opening 2"



SV-2608A	2.0 mm
SV-2608B	2.7 mm
SV-2608C	3.5 mm
SV-2608D	4.5 mm

SV-2608-00
 Drill guide



JO-21-2930 13 cm / 5 1/4"
JO-21-2935 17 cm / 6 3/4"



JO-21-2940 17 cm / 6 3/4"
JO-21-2945 12.5 cm / 5"
 With side cutter



JO-21-1001
 18 cm / 7"



Hudson
10 cm / 4"
Trepine

	Hole size
J-25-051	12.7 mm / 1/2"
J-25-052	19 mm / 3/4"
J-25-053	25.4 mm / 1"
J-25-054	31.75 mm / 1 1/4"
J-25-055	38.1 mm / 1 1/2"



Michele
Trepine

		Inside Ø	Outside Ø
JO-21-997	Small	3 mm	5 mm
JO-21-998	Medium	4 mm	6 mm
JO-21-999	Large	6 mm	8 mm

Facilitates removal of wire and broken bone screws.



JO-21-1475 100 mm
JO-21-1476 50 mm
Aluminum type



JO-21-1480
40 mm



JO-21-1481
60 mm



JO-21-1482
80 mm



JO-21-1483
110 mm

Surgicon Heavy Duty Locking Pliers & Needle Nose Locking Pliers
with a new reinforced, more durable jaw.

- Heavy duty jaws lock securely onto pins.
- Reinforced jaw hinge and housing are more rigid to
- Help prevent side to side shifting.
- Made from 300 and 400 series Surgical grade
- Stainless steel.
- Will not chip or contaminate other instrumentation.
- Adjustment screw for easy control of jaw opening
- One handed, quick release self-locking lever.
- Available in three sizes.



JO-21-1002
17.5 cm / 6 7/8"
Tip width 7 mm
Maximum opening 1"
Small



JO-21-1003
20 cm / 8"
Tip width 9 mm
Maximum opening 1"
Medium



JO-21-1004
25.5 cm / 10"
Tip width 13 mm
Maximum opening 1"
Large



Locking plier



Needle nose locking plier



JO-21-1005
24 cm / 9 1/2"
Length of jaw 2 1/2"
Tip width 5 mm
Jaws are parallel at 3 mm

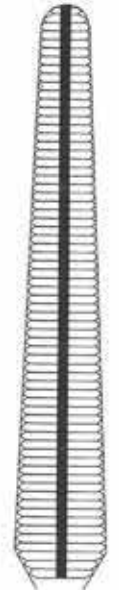

JO-21-1006
30 cm / 12"
Length of jaw 3"
Tip width 7 mm
Jaws are parallel at 5 mm
Large



Surgicon "Diamant"
JO-21-1007
 16 cm / 6 1/4"



JO-21-1008
 16 cm / 6 1/4"
 for soft wires up to 2.5 mm \varnothing
 for hard wires up to 2.0 mm \varnothing



JO-21-2950
 16 cm / 6 1/4"
 for soft wires up to 2.4 mm \varnothing
 for hard wires up to 1.8 mm \varnothing



Instruments with Tungsten Carbide Inserts
TC GOLD



TC Gold
JT-21-1080 16 cm / 6 1/4"
JT-21-1081 18 cm / 7"
JT-21-1082 20 cm / 8"



For up to
 1.6 mm

TC Gold
JT-21-1050 14 cm / 5 1/2"
JT-21-1051 16 cm / 6 1/4"
JT-21-1052 18 cm / 7"



TC Gold
JT-21-1010 22 cm / 8 3/4"
 For soft wires up to 2.6 mm \varnothing
 For hard wires up to 2.2 mm \varnothing

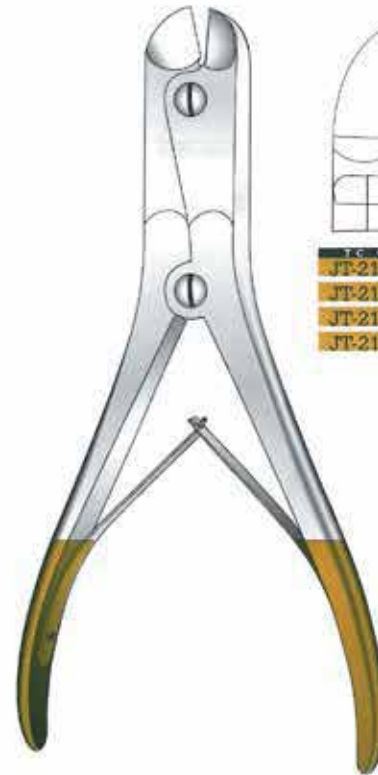

TC Gold
JT-21-1060 14 cm / 5 1/2"
JT-21-1061 16 cm / 6 1/4"
JT-21-1062 18 cm / 7"
JT-21-1063 22 cm / 8 3/4"

For soft wires up to 3 mm \varnothing
 For hard wires up to 2.2 mm \varnothing

Instruments with Tungsten Carbide Inserts

TC GOLD



JO-21-1012
15 cm / 6"
For soft wires up to 2.0 mm Ø
For hard wires up to 1.2 mm Ø



JO-21-1013
24 cm / 9½"

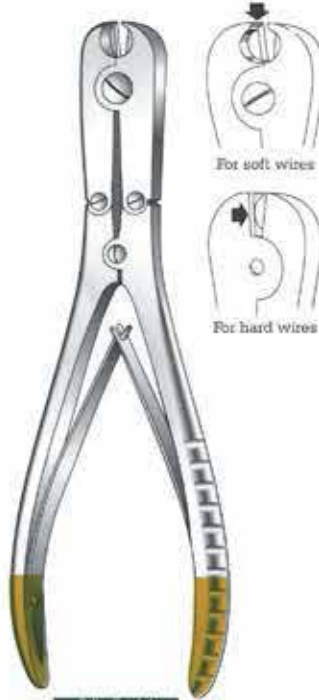

JO-21-1014
18 cm / 7"
For soft wires up to 2 mm Ø
For hard wires up to 1.5 mm Ø



JO-21-1015
17 cm / 6½"
Angled slender pattern for wire removal (for soft wire up to diameter 0.9 mm) after sternum suture



JO-21-1018
22 cm / 8¾"
For soft wire up to 3.5 mm Ø
For hard wire up to 2.5 mm Ø



JO-21-2955
32 cm / 12¾"
For soft wire up to 3.0 mm Ø
For hard wire up to 3.0 mm Ø

Cutter for cutting off kirschner wires
tibia head screws, bolts & pins
up to 3 mm Ø



JO-21-2960
32 cm / 12¾"
Cut three wires at once
For soft wire up to 4.0 mm Ø
For hard wire up to 3.0 mm Ø

Instruments with Tungsten Carbide Inserts
TC GOLD



JO-21-3090
 25 cm / 10"
 For wires up to 3.0 mm
 Head cutter

JO-21-3091
 38 cm / 15"
 For wires up to 4.0 mm
 Head cutter

JT-21-1100	38.5 cm / 15"	For wire
JT-21-1101	45 cm / 17 3/4"	5 mm
JT-21-1102	56 cm / 22"	6 mm
TC wire cutter		7.5 mm



JO-21-3080

30 cm / 12"

JO-21-1018

47 cm / 18 1/2"

Cutter for cutting off kirschner wires,
tibia head screws
bolts, pins up to 6 mm



JO-21-1790

48 cm / 19"

Cutter for cutting off wires,
head screws
and pins up to 6 mm

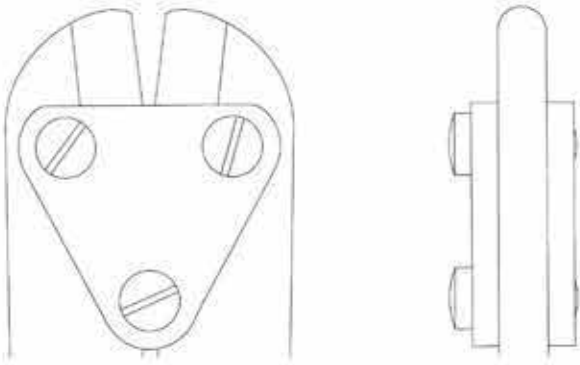

JO-21-1019
24 cm / 9½"
Plate cutting forceps
For cutting stainless steel
mini plates up to 1 mm.



JO-21-1020
38 cm / 15"
Surgeon double action pin cutter
Heavy duty with Carb-N-Sert cutting blades
cut upto 3/16"
Stainless steel

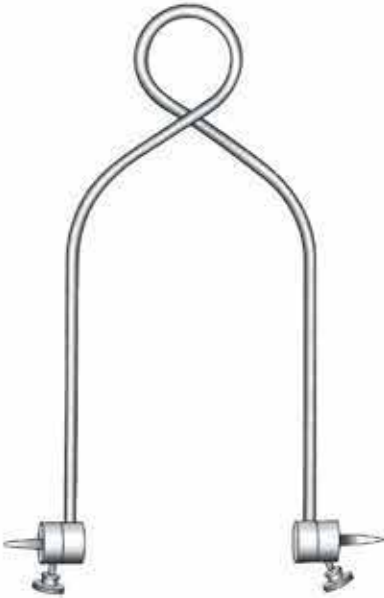

- JO-21-2980** 16 x 9 cm, 6¼" x 3½"
For arm
- JO-21-2982** 21 x 11 cm, 8¼" x 4¼"
For thigh and knee
- JO-21-2984** 21 x 15 cm, 8" x 6"
For femur and knee
- JO-21-2986** 8.5 x 12 cm, 3¼" x 4¾"
10
- JO-21-2988** 11 x 17 cm, 4¼" x 6¾"
10
- JO-21-2990** 15 x 23 cm, 6" x 9"
10

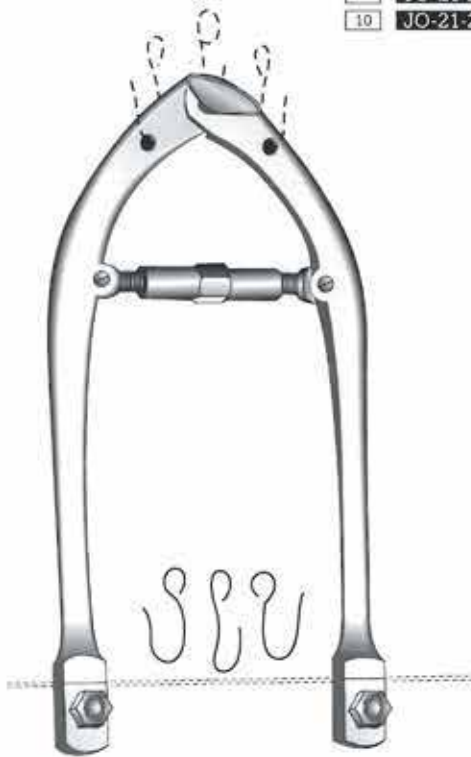

- JO-21-1027** 18 x 10 cm
- JO-21-1028** 27 x 16 cm

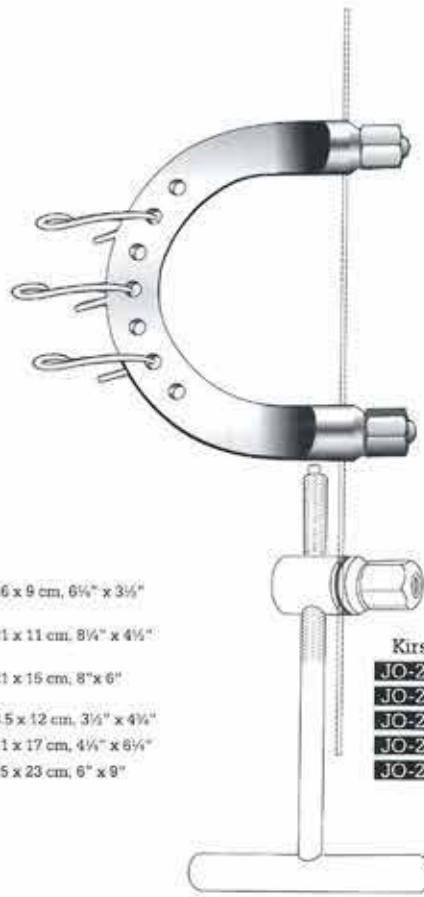

- Kirschner**
- | | H | B |
|-------------------|------|------|
| JO-21-3000 | 9.5 | 7.0 |
| JO-21-3002 | 10.5 | 10.5 |
| JO-21-3004 | 12.0 | 12.0 |
| JO-21-3006 | 15.5 | 15.5 |
| JO-21-3008 | 20.0 | 15.5 |



JO-21-3010



JO-21-3015

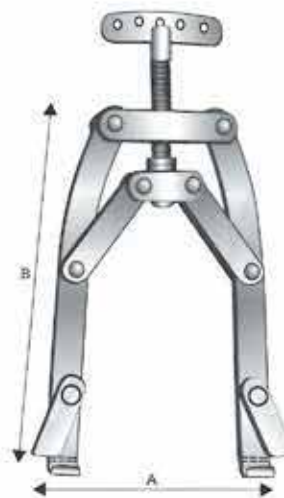

- Kirschner U.S.**
- | | A | B |
|---------------------------|-----|------------|
| JO-21-1031 Small | 100 | 13 x 20 cm |
| JO-21-1032 Medium | 150 | 20 x 27 cm |
| JO-21-1033 Large | | |
| JO-21-1034 X-Large | | |



JO-21-1148
Traction hooklet
for extension bows



JO-21-1149
Traction hooklet
for extension bows

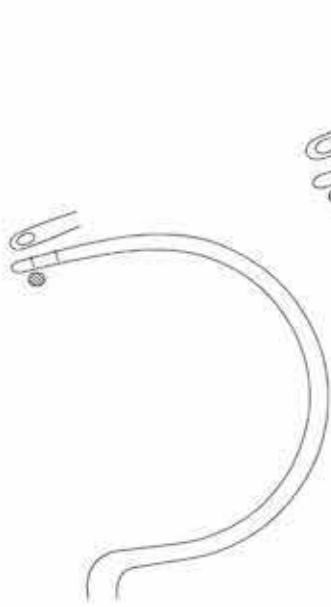

JO-21-1035
 27.5 cm / 10 3/4"
 Fig. 3

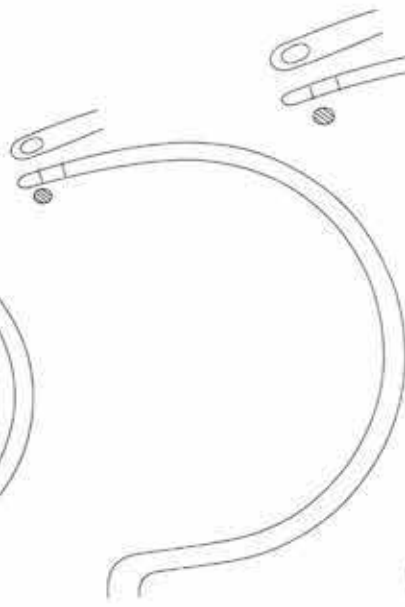

JO-21-1036
 28.5 cm / 11 1/4"
 Fig. 2

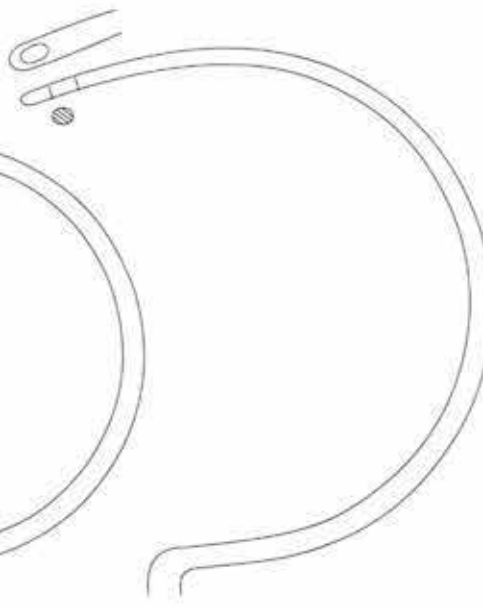

JO-21-1037
 30.5 cm / 12"
 Fig. 1



Demel
 Wire guides

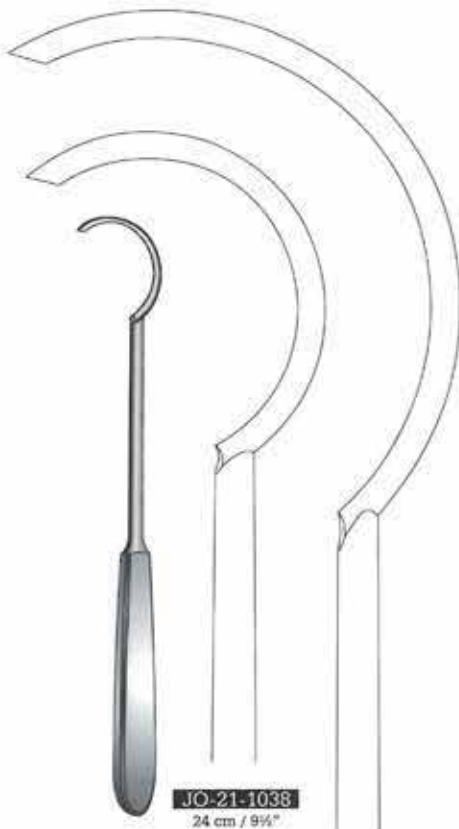

JO-21-1038
 24 cm / 9 1/2"



JO-21-1040
 22.5 cm / 9"

JO-21-1039
 27 cm / 10 3/4"



Graft Passer
JO-21-1120
 XL-Large
 Curved
 Slot cut into head



JO-21-1116
 X-Small



JO-21-1117
 Small



JO-21-1118
 Large



JO-21-1119
 X-Large



Demel
JO-21-1041
 28 cm / 11"



Loute
JO-21-1042
 21 cm / 8 1/4"



JO-21-1105
 Cerclage wire passer



JO-21-1795
 45 mm Ø



JO-21-1800
 70 mm Ø



Kuentscher
 26 cm / 10 1/4"
JO-21-1805 8 mm
JO-21-1806 10 mm
JO-21-1807 12.5 mm



Kuentscher
JO-21-1810
 35 cm / 14"



JO-21-1815
JO-21-1816



JO-21-1820 29 cm / 11 1/2"
JO-21-1821 37 cm / 14 1/4"
JO-21-1822 42 cm / 16 1/2"
JO-21-1823 49 cm / 19 1/4"



JO-21-1830 2.4 mm Ø
JO-21-1831 3.2 mm Ø
JO-21-1832 4.8 mm Ø
JO-21-1833 6.4 mm Ø



JO-21-1840
2.4 mm Ø



JO-21-1845
3.2 mm Ø



JO-21-1850
4.8 mm Ø



JO-21-1855
6.4 mm Ø



JO-21-1860 2.4 mm Ø
JO-21-1861 3.2 mm Ø
JO-21-1862 4.8 mm Ø
JO-21-1863 6.4 mm Ø



Kuentscher
JO-21-1865
21 cm / 8 1/4"



Kuentscher
JO-21-1870
21 cm / 8 1/4"



Kuentscher
JO-21-1875
21 cm / 8 1/4"



Kuentscher
JO-21-1880
Set of 3 books & 1 extension
63 cm / 25 1/2"



JO-21-1881



JO-21-1882



JO-21-1883



JO-21-1884
Extension



JO-21-1885



3.5 mm
4.5 mm
6 mm

4.5 mm
3.5 mm
4 mm

JO-21-1124 3.5 mm, 4.5 mm
JO-21-3030 4.5 mm, 3.5 mm
20 cm / 8"
JO-21-3035 6 mm, 4 mm
25 cm / 10"



2.7 mm
3.5 mm
3.5 mm
2.7 mm

JO-21-1125
14 cm / 5 1/2"
Plate benders
Pair



1.5 mm
1.8 mm
2 mm

JO-21-1126 1.5 mm
JO-21-3040 2 mm
13 cm / 5 1/4"
JO-21-3045 1.8 mm
12 cm / 4 3/4"



JO-21-1138
Large bone plate press
JO-21-3050
Small bone plate press



JO-21-3055
22 cm / 8 3/4"



8.75 x 30 mm

6.75 x 30 mm

JO-21-3060 23 cm / 9"
JO-21-3065 18 cm / 7"
Thickness 14 mm
Wide 8 mm
Bone plate bender



JO-21-1122
Plate bending plier



JO-21-1123
Plate bending plier