





# ***NEUROSURGERY***



 [www.convertualinterlogic.com](http://www.convertualinterlogic.com)

 +234 8033200998  
+234 8180003461

 [enquiries@convertualinterlogic.com](mailto:enquiries@convertualinterlogic.com)

 1 Anu Crescent, Off Ado-Badore Road,  
Ajah, Lagos, Nigeria

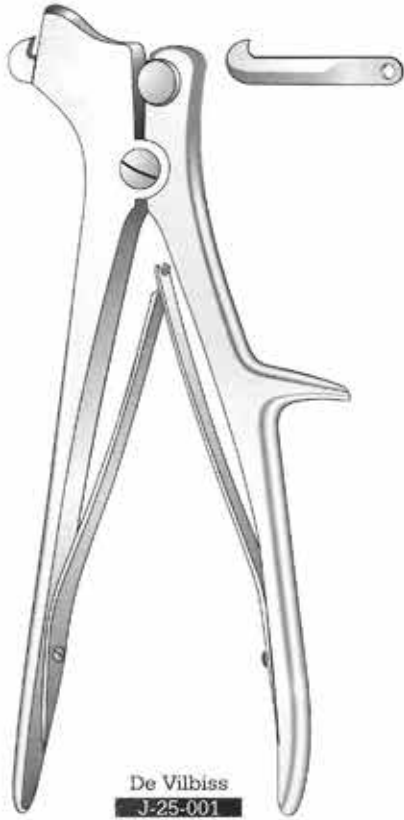

De Vilbiss  
**J-25-001**  
 21 cm / 8 1/4"



Dahlgren  
**J-25-010**  
 20 cm / 8"



Cone  
**J-25-750**  
 22.5 cm / 9"  
 Cranial punch



Martel  
**J-25-020**  
 33 cm / 13"  
 Saw guide, Flexible



**Crutchfield**  
**J-25-040**  
 Small pattern



**Crutchfield**  
**J-25-050**  
 Medium pattern

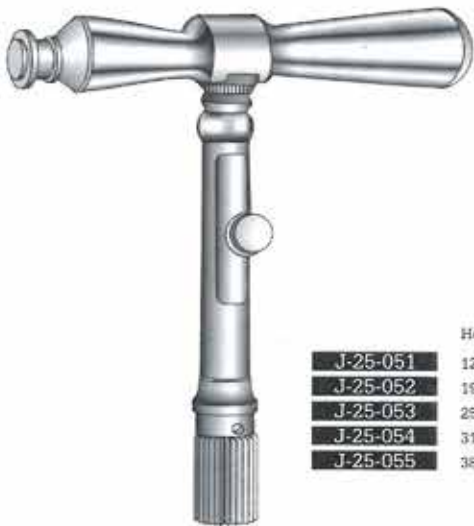

**Hudson**  
 10 cm / 4"  
 Tophine

	Hole size
<b>J-25-051</b>	12.7 mm / 1/2"
<b>J-25-052</b>	19 mm / 3/4"
<b>J-25-053</b>	25.4 mm / 1"
<b>J-25-054</b>	31.75 mm / 1 1/4"
<b>J-25-055</b>	38.1 mm / 1 1/2"



<b>J-25-060</b>	<b>J-25-070</b>
7 cm / 2 3/4"	7 cm / 2 3/4"
3.5 mm Ø	5 mm Ø
Drill point	Drill point

**J-25-760** Small  
**J-25-761** Large

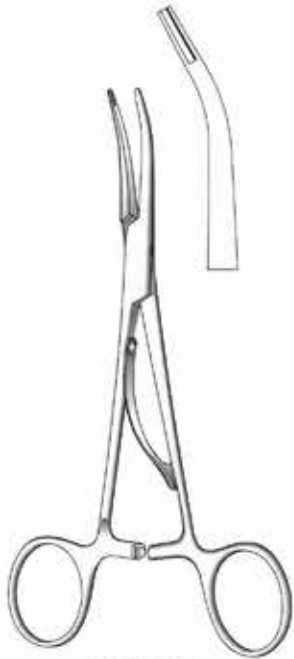

**McKenzie**  
**J-25-080** 15 cm / 6"  
**J-25-090** 19 cm / 7½"

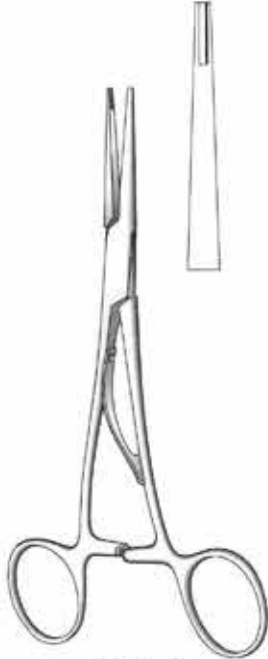

**McKenzie**  
**J-25-100** 15 cm / 6"  
**J-25-110** 19 cm / 7½"



**Smithwick**  
**J-25-120** 23 cm / 9"  
**J-25-130** 26 cm / 10¼"

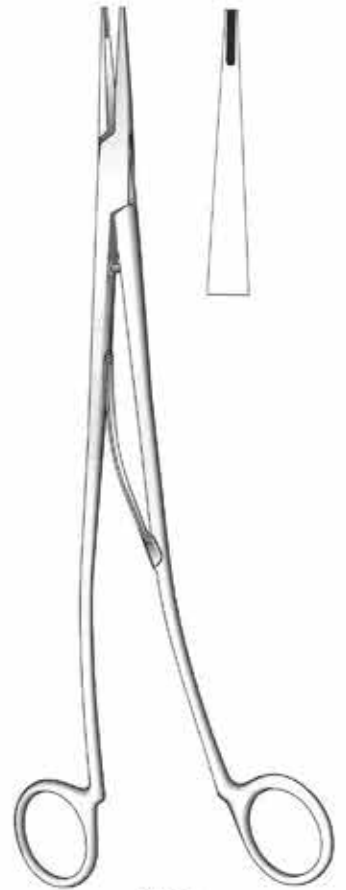

**Sweet**  
**J-25-140** 23 cm / 9"  
**J-25-150** 25 cm / 10"

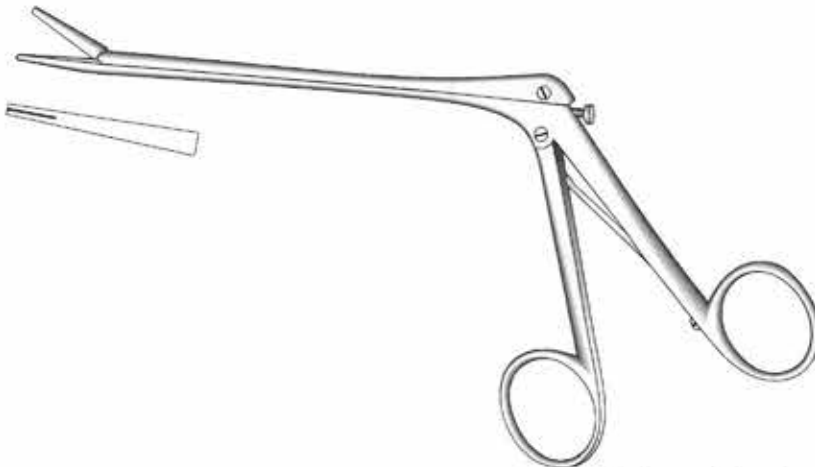

**Olivecrona Toennis**  
**J-25-160**  
 14 cm / 5½"

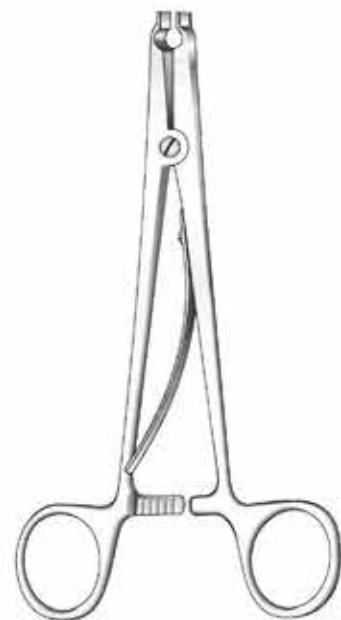

**Raney**  
**J-25-170**  
 16.5 cm / 6½"

# Neurosurgery

Nerve Root Retractors and Brain Spatula

Nervwurzelnaken und I-Iirnspatel

Separadores para la raiz de nervio y Espatulas Cerebrales



**Cushing**

<b>J-25-210</b>	17 cm / 6 3/4"
<b>J-25-220</b>	20 cm / 8"
<b>J-25-230</b>	28 cm / 11 1/4"



**Olivecrona**

<b>J-25-240</b>	7 x 9 mm
<b>J-25-250</b>	11 x 13 mm
<b>J-25-260</b>	15 x 18 mm
<b>J-25-270</b>	18 x 22 mm
18 cm / 7"	
Concave	



**Olivecrona**

<b>J-25-280</b>	7 x 9 mm
<b>J-25-290</b>	11 x 13 mm
<b>J-25-300</b>	15 x 18 mm
<b>J-25-310</b>	18 x 22 mm
18 cm / 7"	
Convex	

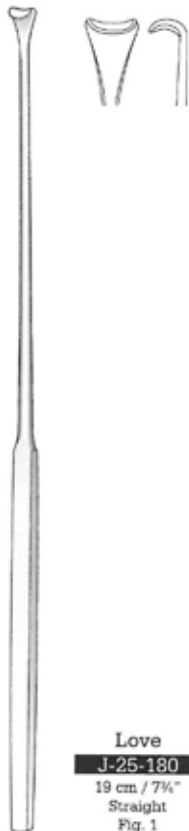

**Love**  
**J-25-180**  
19 cm / 7 1/2"  
Straight  
Fig. 1

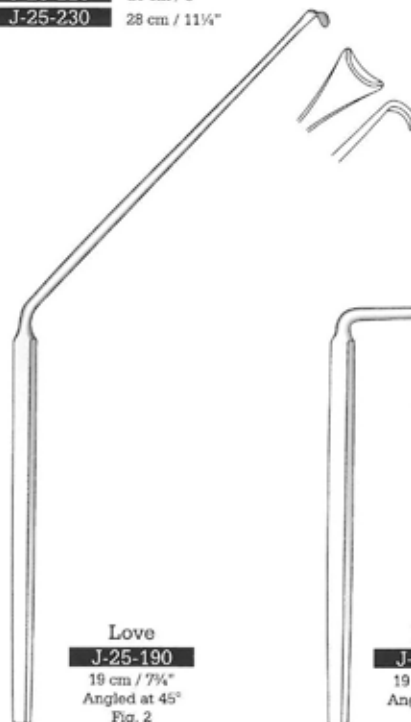

**Love**  
**J-25-190**  
19 cm / 7 1/2"  
Angled at 45°  
Fig. 2

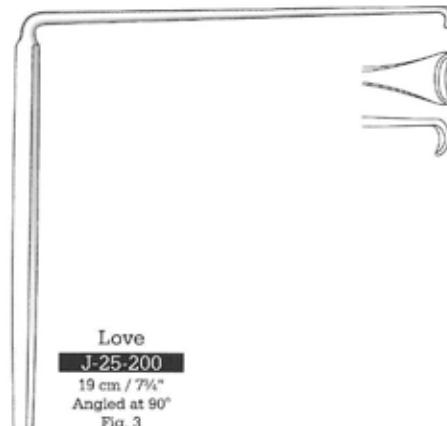

**Love**  
**J-25-200**  
19 cm / 7 1/2"  
Angled at 90°  
Fig. 3



**Davis**  
**J-25-181**  
 24.5 cm / 9 3/4"



**Sachs**  
**J-25-182**  
 21 cm / 8 1/4"

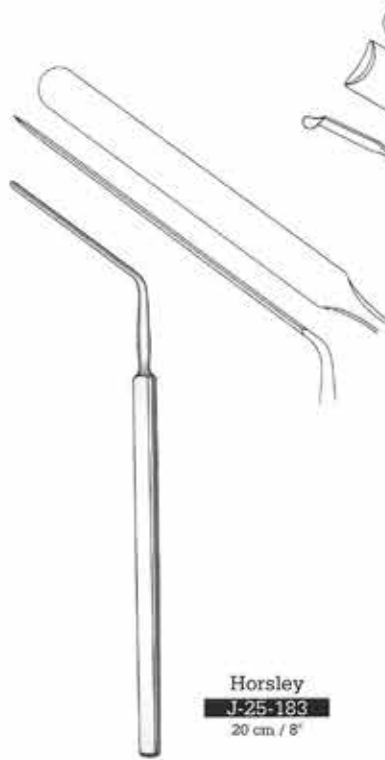

**Horsley**  
**J-25-183**  
 20 cm / 8"



**Scoville**  
**J-25-184**  
 20 cm / 8"

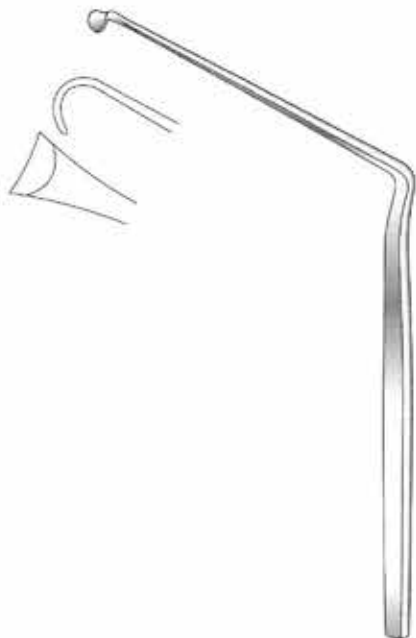

**Surgicon**  
**J-25-185**  
 21 cm / 8 1/4"



**Scoville**  
**J-25-186**  
 23 cm / 9"

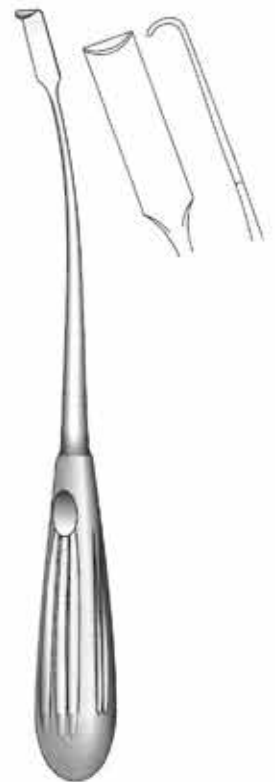

**Holsher**  
**J-25-187**  
 24 cm / 9 1/2"

# Neurosurgery

Nerve Retractors

Nervwurzelnhaken

Separadores para la raiz de nervio



Cushing  
J-25-188  
21.5 cm / 8 1/2"



Sachs  
J-25-189  
21.5 cm / 8 1/2"



Sachs  
J-25-191  
21.5 cm / 8 1/2"



Cushing  
J-25-192  
23 cm / 9"



Sachs  
J-25-193  
21.5 cm / 8 1/2"



**Dandy**  
**J-25-320**  
 20 cm / 8"



**Dandy**  
**J-25-330**  
 20 cm / 8"



**Dandy**  
**J-25-340**  
 20 cm / 8"



Cushing



Fig. 1  
**J-25-360** 19 cm / 7 1/4"  
**J-25-361** 28 cm / 11"



Fig. 2  
**J-25-370**  
**J-25-371**



**Graham**  
**J-25-390**  
 18.5 cm / 6 1/2"  
 Blunt



**Sachs**  
**J-25-400**  
 18.5 cm / 7 1/4"  
 Sharp



**Cushing**  
**J-25-410**  
 14 cm / 5 1/2"



**J-25-420** 13 cm / 5"  
**J-25-430** 18 cm / 7"  
 Sharp



**J-25-440**  
**J-25-450**  
 Blunt



**Smithwick**  
**J-25-460**  
 29 cm / 11 1/2"



**Adson**  
**J-25-910**  
 20 cm / 8"  
 Sharp blade 5 mm at right angle



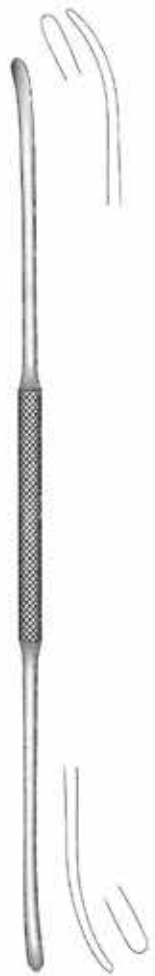

**Olivecrona**  
J-25-391 19.5 cm / 7 7/8"  
J-25-392 24 cm / 9 1/2"

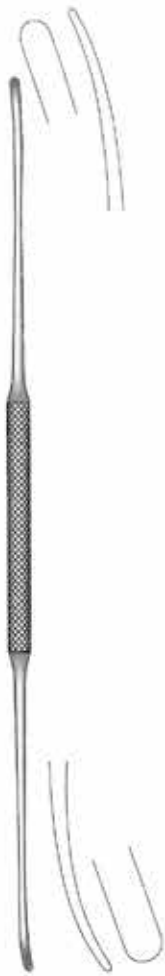

**Olivecrona**  
J-25-393 18 cm / 7"  
J-25-394 24 cm / 9 1/2"

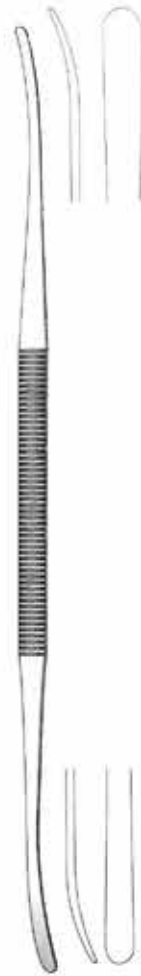

**Toennis**  
J-25-395 26 cm / 10"



**Milligan**  
J-25-396 21 cm / 8 1/4"



**J-25-397**  
22 cm / 8 3/4"

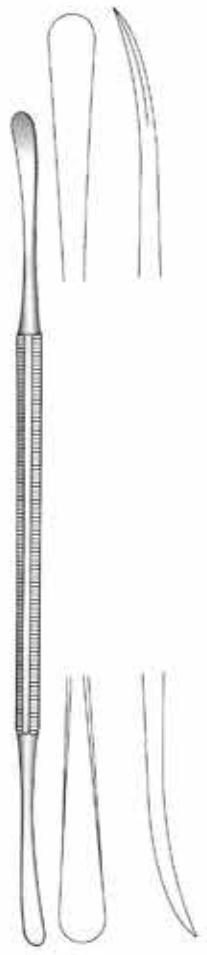

**Sachs**  
J-25-398 21 cm / 8 1/4"



Sachs  
J-25-399  
21 cm / 8 3/4"

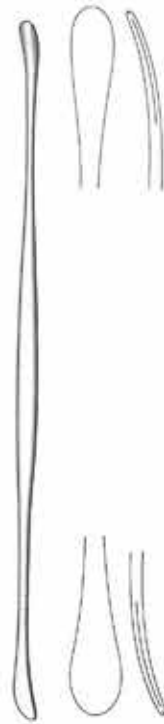

Penfield  
J-25-401  
29 cm / 11 1/2"



Penfield  
J-25-402  
17.5 cm / 7"



Penfield  
J-25-403  
21.5 cm / 8 1/2"



Hoen  
J-25-404  
15 cm / 6"



Hoen  
J-25-405  
15 cm / 6"



Frazier  
J-25-406  
15 cm / 6"

# NeuroSurgery

Exploring Cannula, Suction tubes and Tampons Cannula  
Punktionskanulen, Saugkanulen und Tamponrohre  
Canulas Ventriculares, Tubos de aspiration y Canula P/tapones



For more suction tubes see page 22

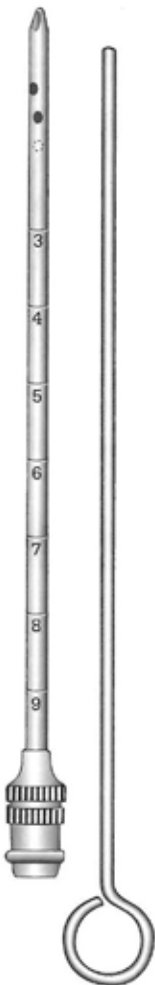

**Frazier**  
**J-25-470**  
3 mm Ø  
Silver plated

**J-25-475**  
2 mm Ø  
Gold plated  
12 cm / 4 3/4"

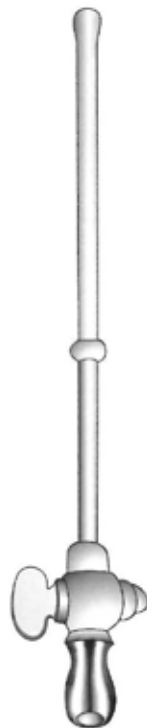

**Seiffert**  
**J-25-530**  
12.5 cm / 5"



**Elsberg**  
**J-25-920**  
11 cm / 4 3/4"  
7 Fr. 2.3 mm, luer lock sterling,  
3 hole closed end

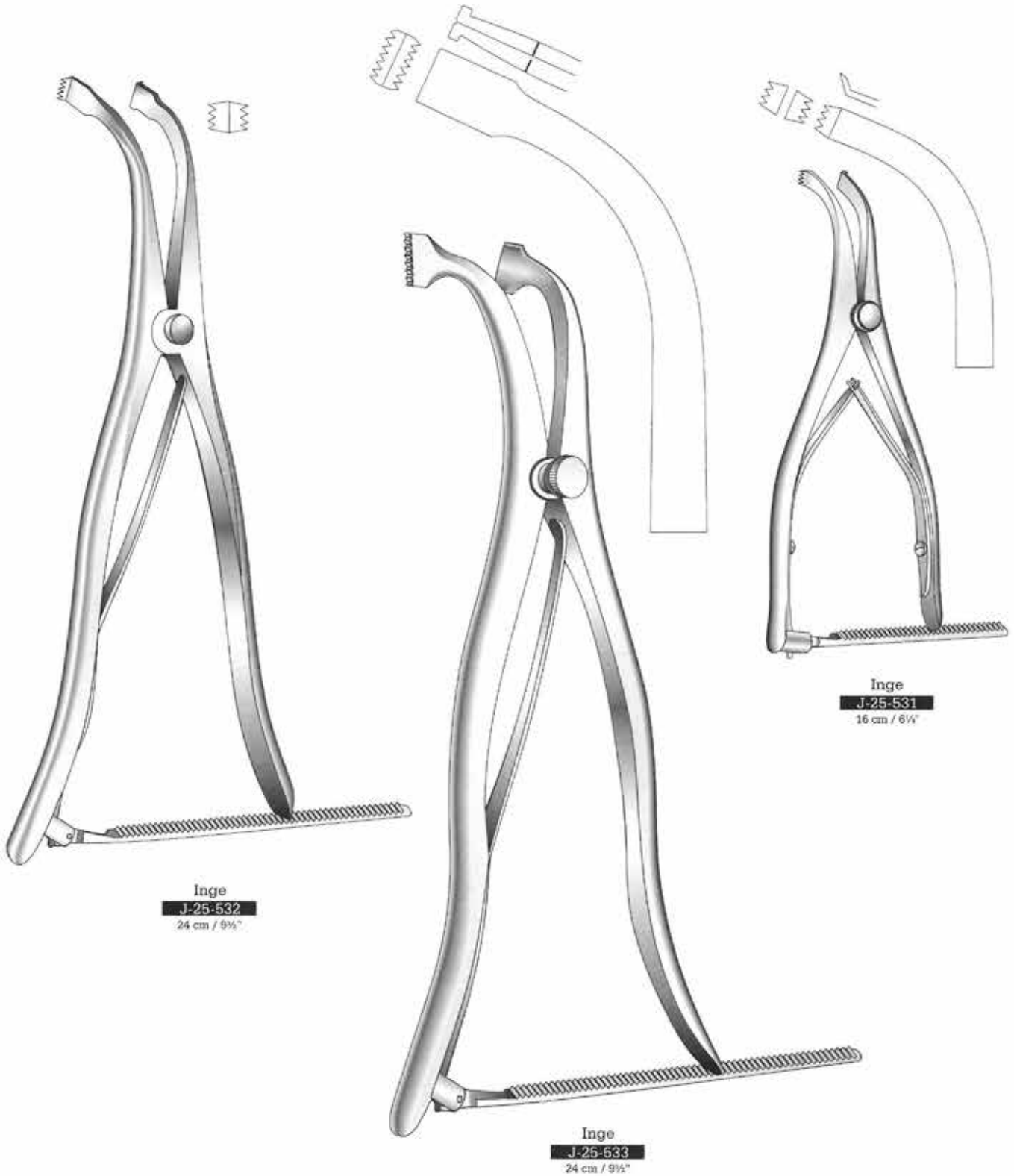

# NeuroSurgery

Lamina Spreaders, Wound Spreaders

Wirbelkörperspreizer, Wundspreizer

Separadores para cuerpos vertebrales, Separadores autoostaticos

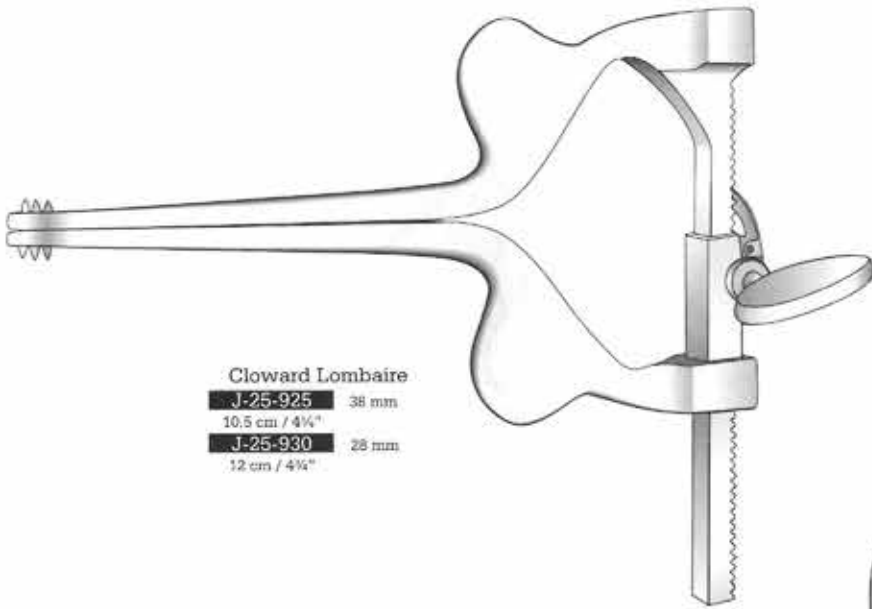

Cloward Lombaire

J-25-925 38 mm

10.5 cm / 4 1/4"

J-25-930 28 mm

12 cm / 4 3/4"

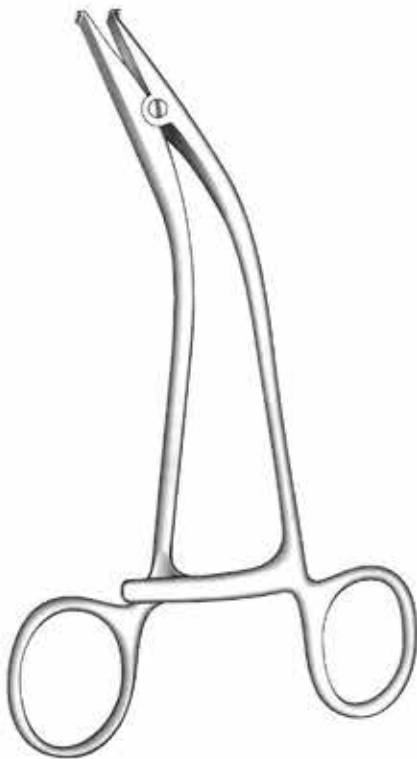

Cloward

J-25-940 16 cm / 6 1/4"

J-25-945 20 cm / 8"

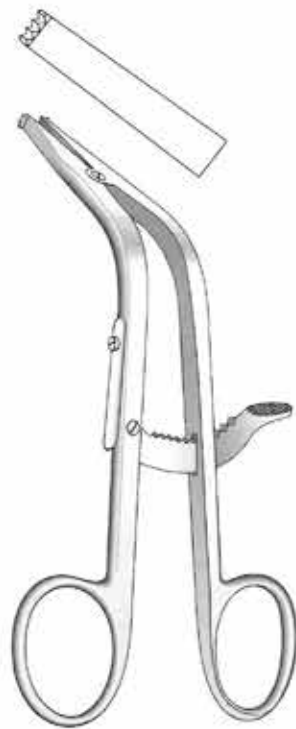

Cloward

J-25-535

16 cm / 6 1/4"

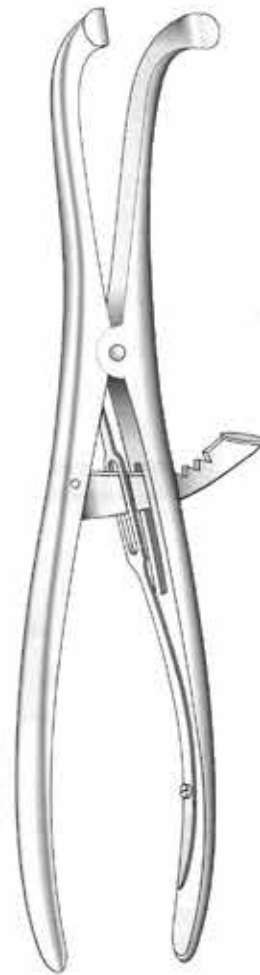

Mathey

J-25-800

18 cm / 7"



Maurer

J-25-805

20 cm / 8"

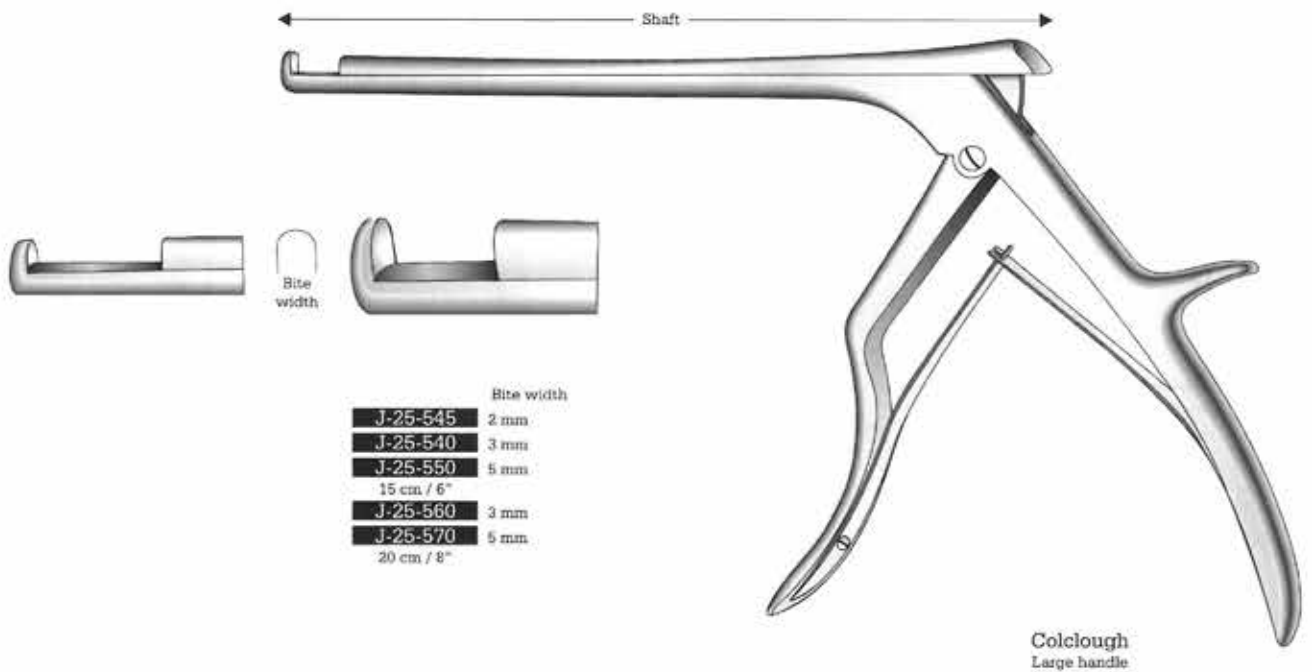
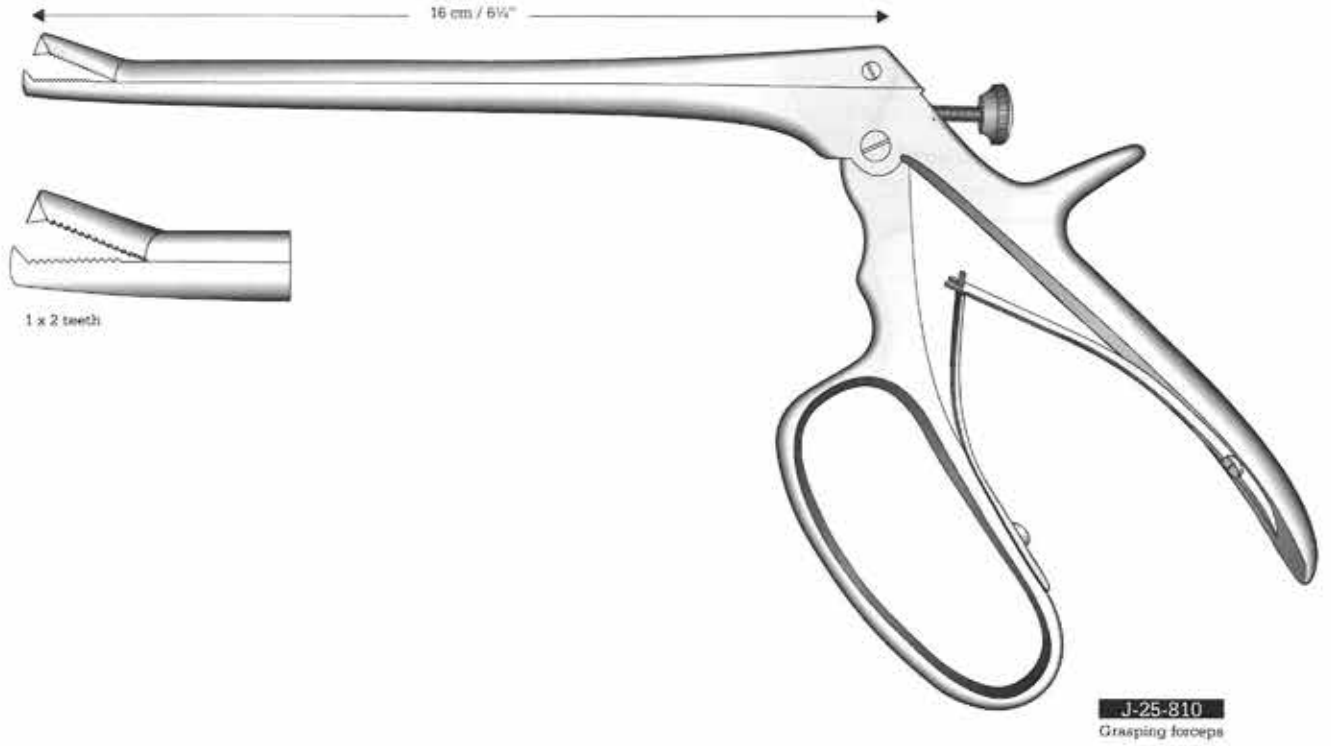

# Neurosurgery

Intervertebral Disc Rongeurs





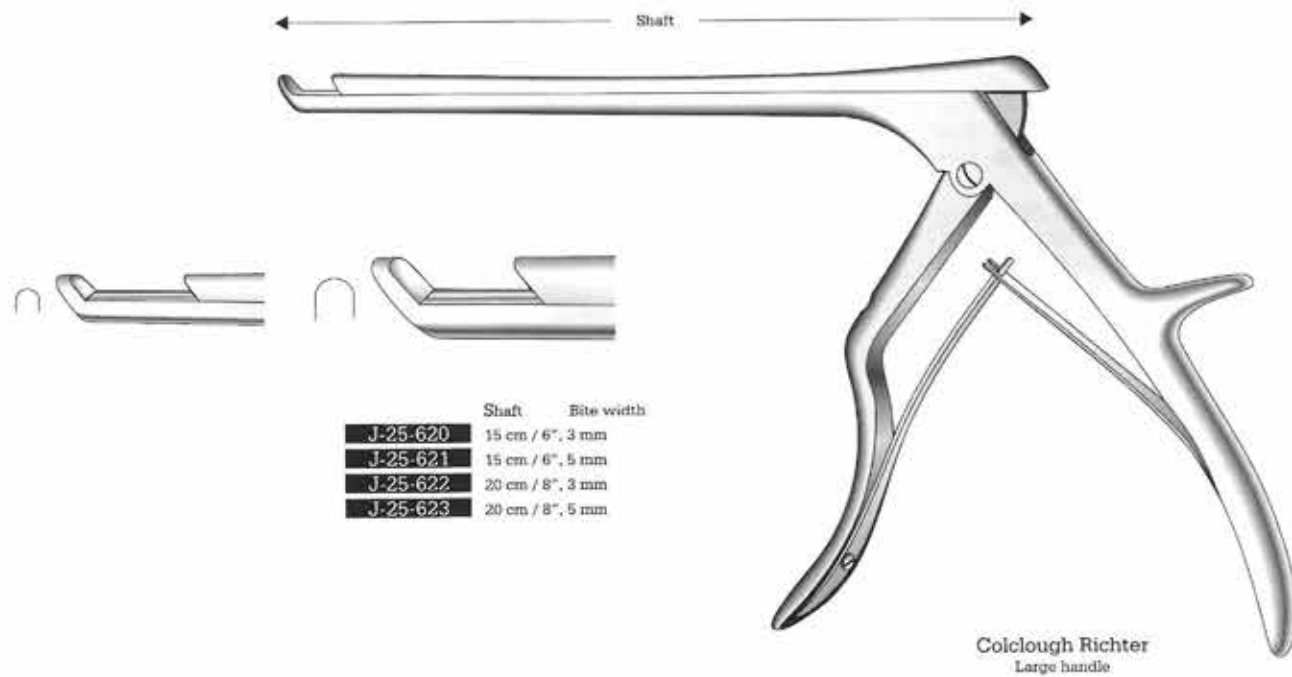
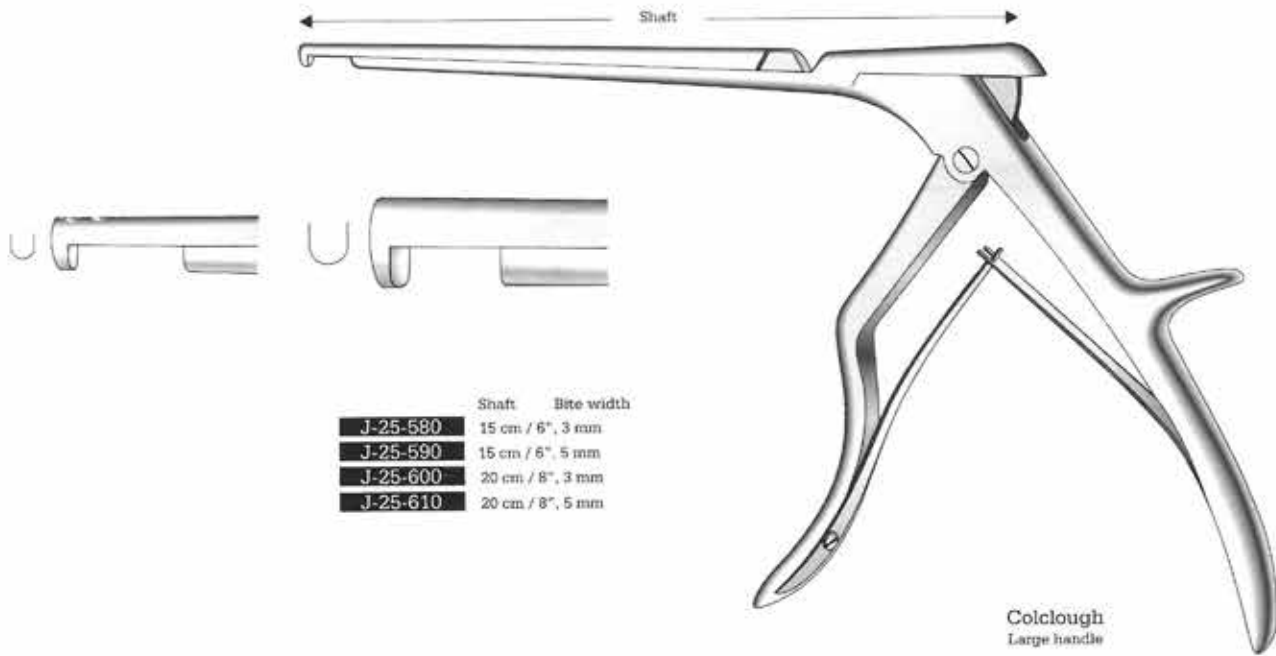

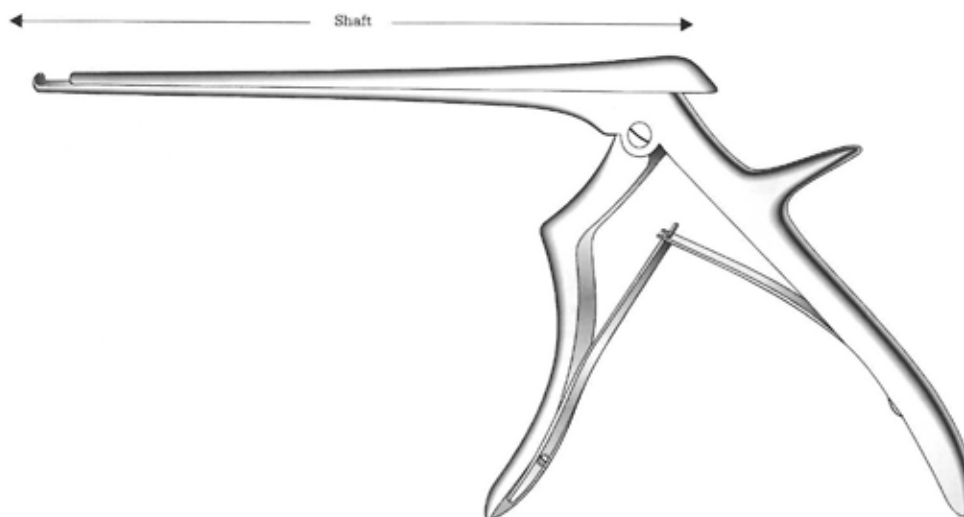







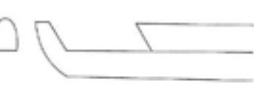

Bandscheibenstanzen

Pinzas cortantes para discos intervertebrales



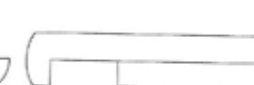

Ferris-Smith-Kerrison

Upward cutting	Downward cutting	Forward cutting
 <p style="text-align: center;"> <b>J-25-1100</b> 15 cm  <b>J-25-1101</b> 18 cm  <b>J-25-1102</b> 20 cm                      1 mm                 </p>	 <p style="text-align: center;"> <b>J-25-1130</b> 15 cm  <b>J-25-1131</b> 18 cm  <b>J-25-1132</b> 20 cm                      1 mm                 </p>	 <p style="text-align: center;"> <b>J-25-1160</b> 15 cm  <b>J-25-1161</b> 18 cm  <b>J-25-1162</b> 20 cm                      1 mm                 </p>
 <p style="text-align: center;"> <b>J-25-1105</b> 15 cm  <b>J-25-1106</b> 18 cm  <b>J-25-1107</b> 20 cm                      2 mm                 </p>	 <p style="text-align: center;"> <b>J-25-1135</b> 15 cm  <b>J-25-1136</b> 18 cm  <b>J-25-1137</b> 20 cm                      2 mm                 </p>	 <p style="text-align: center;"> <b>J-25-1165</b> 15 cm  <b>J-25-1166</b> 18 cm  <b>J-25-1167</b> 20 cm                      2 mm                 </p>
 <p style="text-align: center;"> <b>J-25-1110</b> 15 cm  <b>J-25-1111</b> 18 cm  <b>J-25-1112</b> 20 cm                      3 mm                 </p>	 <p style="text-align: center;"> <b>J-25-1140</b> 15 cm  <b>J-25-1141</b> 18 cm  <b>J-25-1142</b> 20 cm                      3 mm                 </p>	 <p style="text-align: center;"> <b>J-25-1170</b> 15 cm  <b>J-25-1171</b> 18 cm  <b>J-25-1172</b> 20 cm                      3 mm                 </p>
 <p style="text-align: center;"> <b>J-25-1115</b> 15 cm  <b>J-25-1116</b> 18 cm  <b>J-25-1117</b> 20 cm                      4 mm                 </p>	 <p style="text-align: center;"> <b>J-25-1145</b> 15 cm  <b>J-25-1146</b> 18 cm  <b>J-25-1147</b> 20 cm                      4 mm                 </p>	 <p style="text-align: center;"> <b>J-25-1175</b> 15 cm  <b>J-25-1176</b> 18 cm  <b>J-25-1177</b> 20 cm                      4 mm                 </p>
 <p style="text-align: center;"> <b>J-25-1120</b> 15 cm  <b>J-25-1121</b> 18 cm  <b>J-25-1122</b> 20 cm                      5 mm                 </p>	 <p style="text-align: center;"> <b>J-25-1150</b> 15 cm  <b>J-25-1151</b> 18 cm  <b>J-25-1152</b> 20 cm                      5 mm                 </p>	 <p style="text-align: center;"> <b>J-25-1180</b> 15 cm  <b>J-25-1181</b> 18 cm  <b>J-25-1182</b> 20 cm                      5 mm                 </p>
 <p style="text-align: center;"> <b>J-25-1125</b> 15 cm  <b>J-25-1126</b> 18 cm  <b>J-25-1127</b> 20 cm                      6 mm                 </p>	 <p style="text-align: center;"> <b>J-25-1155</b> 15 cm  <b>J-25-1156</b> 18 cm  <b>J-25-1157</b> 20 cm                      6 mm                 </p>	 <p style="text-align: center;"> <b>J-25-1185</b> 15 cm  <b>J-25-1186</b> 18 cm  <b>J-25-1187</b> 20 cm                      6 mm                 </p>



# Neurosurgery

Intervertebral Disc Rongeurs

Bandscheibenstanzen



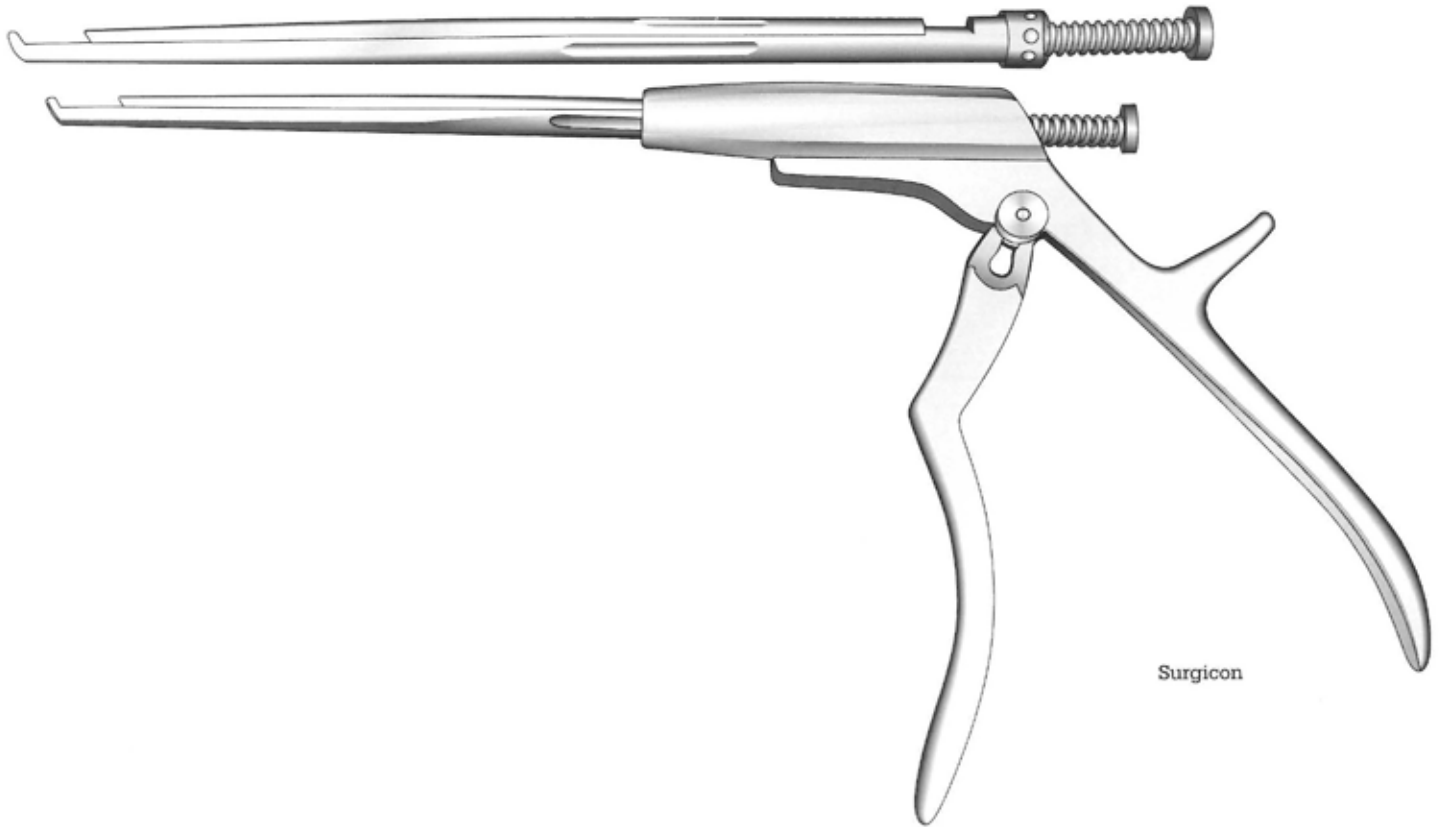







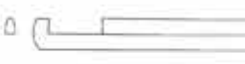
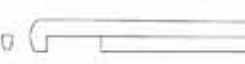





Pinzas cortantes para discos intervertebrales

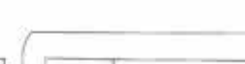

Upward cutting	
	J-25-1200 15 cm J-25-1201 18 cm J-25-1202 20 cm 1 mm
	J-25-1205 15 cm J-25-1206 18 cm J-25-1207 20 cm 2 mm
	J-25-1210 15 cm J-25-1211 18 cm J-25-1212 20 cm 3 mm
	J-25-1215 15 cm J-25-1216 18 cm J-25-1217 20 cm 4 mm
	J-25-1220 15 cm J-25-1221 18 cm J-25-1222 20 cm 5 mm
	J-25-1225 15 cm J-25-1226 18 cm J-25-1227 20 cm 6 mm

Forward cutting	
	J-25-1230 15 cm J-25-1231 18 cm J-25-1232 20 cm 1 mm
	J-25-1235 15 cm J-25-1236 18 cm J-25-1237 20 cm 2 mm
	J-25-1240 15 cm J-25-1241 18 cm J-25-1242 20 cm 3 mm
	J-25-1245 15 cm J-25-1246 18 cm J-25-1247 20 cm 4 mm
	J-25-1250 15 cm J-25-1251 18 cm J-25-1252 20 cm 5 mm
	J-25-1255 15 cm J-25-1256 18 cm J-25-1257 20 cm 6 mm



Upward cutting	Downward cutting	Forward cutting																								
 <table border="0"> <tr><td><b>J-25-1300</b></td><td>15 cm</td></tr> <tr><td><b>J-25-1301</b></td><td>18 cm</td></tr> <tr><td><b>J-25-1302</b></td><td>20 cm</td></tr> <tr><td colspan="2" style="text-align: center;">1 mm</td></tr> </table>	<b>J-25-1300</b>	15 cm	<b>J-25-1301</b>	18 cm	<b>J-25-1302</b>	20 cm	1 mm		 <table border="0"> <tr><td><b>J-25-1330</b></td><td>15 cm</td></tr> <tr><td><b>J-25-1331</b></td><td>18 cm</td></tr> <tr><td><b>J-25-1332</b></td><td>20 cm</td></tr> <tr><td colspan="2" style="text-align: center;">1 mm</td></tr> </table>	<b>J-25-1330</b>	15 cm	<b>J-25-1331</b>	18 cm	<b>J-25-1332</b>	20 cm	1 mm		 <table border="0"> <tr><td><b>J-25-1360</b></td><td>15 cm</td></tr> <tr><td><b>J-25-1361</b></td><td>18 cm</td></tr> <tr><td><b>J-25-1362</b></td><td>20 cm</td></tr> <tr><td colspan="2" style="text-align: center;">1 mm</td></tr> </table>	<b>J-25-1360</b>	15 cm	<b>J-25-1361</b>	18 cm	<b>J-25-1362</b>	20 cm	1 mm	
<b>J-25-1300</b>	15 cm																									
<b>J-25-1301</b>	18 cm																									
<b>J-25-1302</b>	20 cm																									
1 mm																										
<b>J-25-1330</b>	15 cm																									
<b>J-25-1331</b>	18 cm																									
<b>J-25-1332</b>	20 cm																									
1 mm																										
<b>J-25-1360</b>	15 cm																									
<b>J-25-1361</b>	18 cm																									
<b>J-25-1362</b>	20 cm																									
1 mm																										
 <table border="0"> <tr><td><b>J-25-1305</b></td><td>15 cm</td></tr> <tr><td><b>J-25-1306</b></td><td>18 cm</td></tr> <tr><td><b>J-25-1307</b></td><td>20 cm</td></tr> <tr><td colspan="2" style="text-align: center;">2 mm</td></tr> </table>	<b>J-25-1305</b>	15 cm	<b>J-25-1306</b>	18 cm	<b>J-25-1307</b>	20 cm	2 mm		 <table border="0"> <tr><td><b>J-25-1335</b></td><td>15 cm</td></tr> <tr><td><b>J-25-1336</b></td><td>18 cm</td></tr> <tr><td><b>J-25-1337</b></td><td>20 cm</td></tr> <tr><td colspan="2" style="text-align: center;">2 mm</td></tr> </table>	<b>J-25-1335</b>	15 cm	<b>J-25-1336</b>	18 cm	<b>J-25-1337</b>	20 cm	2 mm		 <table border="0"> <tr><td><b>J-25-1365</b></td><td>15 cm</td></tr> <tr><td><b>J-25-1366</b></td><td>18 cm</td></tr> <tr><td><b>J-25-1367</b></td><td>20 cm</td></tr> <tr><td colspan="2" style="text-align: center;">2 mm</td></tr> </table>	<b>J-25-1365</b>	15 cm	<b>J-25-1366</b>	18 cm	<b>J-25-1367</b>	20 cm	2 mm	
<b>J-25-1305</b>	15 cm																									
<b>J-25-1306</b>	18 cm																									
<b>J-25-1307</b>	20 cm																									
2 mm																										
<b>J-25-1335</b>	15 cm																									
<b>J-25-1336</b>	18 cm																									
<b>J-25-1337</b>	20 cm																									
2 mm																										
<b>J-25-1365</b>	15 cm																									
<b>J-25-1366</b>	18 cm																									
<b>J-25-1367</b>	20 cm																									
2 mm																										
 <table border="0"> <tr><td><b>J-25-1310</b></td><td>15 cm</td></tr> <tr><td><b>J-25-1311</b></td><td>18 cm</td></tr> <tr><td><b>J-25-1312</b></td><td>20 cm</td></tr> <tr><td colspan="2" style="text-align: center;">3 mm</td></tr> </table>	<b>J-25-1310</b>	15 cm	<b>J-25-1311</b>	18 cm	<b>J-25-1312</b>	20 cm	3 mm		 <table border="0"> <tr><td><b>J-25-1340</b></td><td>15 cm</td></tr> <tr><td><b>J-25-1341</b></td><td>18 cm</td></tr> <tr><td><b>J-25-1342</b></td><td>20 cm</td></tr> <tr><td colspan="2" style="text-align: center;">3 mm</td></tr> </table>	<b>J-25-1340</b>	15 cm	<b>J-25-1341</b>	18 cm	<b>J-25-1342</b>	20 cm	3 mm		 <table border="0"> <tr><td><b>J-25-1370</b></td><td>15 cm</td></tr> <tr><td><b>J-25-1371</b></td><td>18 cm</td></tr> <tr><td><b>J-25-1372</b></td><td>20 cm</td></tr> <tr><td colspan="2" style="text-align: center;">3 mm</td></tr> </table>	<b>J-25-1370</b>	15 cm	<b>J-25-1371</b>	18 cm	<b>J-25-1372</b>	20 cm	3 mm	
<b>J-25-1310</b>	15 cm																									
<b>J-25-1311</b>	18 cm																									
<b>J-25-1312</b>	20 cm																									
3 mm																										
<b>J-25-1340</b>	15 cm																									
<b>J-25-1341</b>	18 cm																									
<b>J-25-1342</b>	20 cm																									
3 mm																										
<b>J-25-1370</b>	15 cm																									
<b>J-25-1371</b>	18 cm																									
<b>J-25-1372</b>	20 cm																									
3 mm																										
 <table border="0"> <tr><td><b>J-25-1315</b></td><td>15 cm</td></tr> <tr><td><b>J-25-1316</b></td><td>18 cm</td></tr> <tr><td><b>J-25-1317</b></td><td>20 cm</td></tr> <tr><td colspan="2" style="text-align: center;">4 mm</td></tr> </table>	<b>J-25-1315</b>	15 cm	<b>J-25-1316</b>	18 cm	<b>J-25-1317</b>	20 cm	4 mm		 <table border="0"> <tr><td><b>J-25-1345</b></td><td>15 cm</td></tr> <tr><td><b>J-25-1346</b></td><td>18 cm</td></tr> <tr><td><b>J-25-1347</b></td><td>20 cm</td></tr> <tr><td colspan="2" style="text-align: center;">4 mm</td></tr> </table>	<b>J-25-1345</b>	15 cm	<b>J-25-1346</b>	18 cm	<b>J-25-1347</b>	20 cm	4 mm		 <table border="0"> <tr><td><b>J-25-1375</b></td><td>15 cm</td></tr> <tr><td><b>J-25-1376</b></td><td>18 cm</td></tr> <tr><td><b>J-25-1377</b></td><td>20 cm</td></tr> <tr><td colspan="2" style="text-align: center;">4 mm</td></tr> </table>	<b>J-25-1375</b>	15 cm	<b>J-25-1376</b>	18 cm	<b>J-25-1377</b>	20 cm	4 mm	
<b>J-25-1315</b>	15 cm																									
<b>J-25-1316</b>	18 cm																									
<b>J-25-1317</b>	20 cm																									
4 mm																										
<b>J-25-1345</b>	15 cm																									
<b>J-25-1346</b>	18 cm																									
<b>J-25-1347</b>	20 cm																									
4 mm																										
<b>J-25-1375</b>	15 cm																									
<b>J-25-1376</b>	18 cm																									
<b>J-25-1377</b>	20 cm																									
4 mm																										
 <table border="0"> <tr><td><b>J-25-1320</b></td><td>15 cm</td></tr> <tr><td><b>J-25-1321</b></td><td>18 cm</td></tr> <tr><td><b>J-25-1322</b></td><td>20 cm</td></tr> <tr><td colspan="2" style="text-align: center;">5 mm</td></tr> </table>	<b>J-25-1320</b>	15 cm	<b>J-25-1321</b>	18 cm	<b>J-25-1322</b>	20 cm	5 mm		 <table border="0"> <tr><td><b>J-25-1350</b></td><td>15 cm</td></tr> <tr><td><b>J-25-1351</b></td><td>18 cm</td></tr> <tr><td><b>J-25-1352</b></td><td>20 cm</td></tr> <tr><td colspan="2" style="text-align: center;">5 mm</td></tr> </table>	<b>J-25-1350</b>	15 cm	<b>J-25-1351</b>	18 cm	<b>J-25-1352</b>	20 cm	5 mm		 <table border="0"> <tr><td><b>J-25-1380</b></td><td>15 cm</td></tr> <tr><td><b>J-25-1381</b></td><td>18 cm</td></tr> <tr><td><b>J-25-1382</b></td><td>20 cm</td></tr> <tr><td colspan="2" style="text-align: center;">5 mm</td></tr> </table>	<b>J-25-1380</b>	15 cm	<b>J-25-1381</b>	18 cm	<b>J-25-1382</b>	20 cm	5 mm	
<b>J-25-1320</b>	15 cm																									
<b>J-25-1321</b>	18 cm																									
<b>J-25-1322</b>	20 cm																									
5 mm																										
<b>J-25-1350</b>	15 cm																									
<b>J-25-1351</b>	18 cm																									
<b>J-25-1352</b>	20 cm																									
5 mm																										
<b>J-25-1380</b>	15 cm																									
<b>J-25-1381</b>	18 cm																									
<b>J-25-1382</b>	20 cm																									
5 mm																										
 <table border="0"> <tr><td><b>J-25-1325</b></td><td>15 cm</td></tr> <tr><td><b>J-25-1326</b></td><td>18 cm</td></tr> <tr><td><b>J-25-1327</b></td><td>20 cm</td></tr> <tr><td colspan="2" style="text-align: center;">6 mm</td></tr> </table>	<b>J-25-1325</b>	15 cm	<b>J-25-1326</b>	18 cm	<b>J-25-1327</b>	20 cm	6 mm		 <table border="0"> <tr><td><b>J-25-1355</b></td><td>15 cm</td></tr> <tr><td><b>J-25-1356</b></td><td>18 cm</td></tr> <tr><td><b>J-25-1357</b></td><td>20 cm</td></tr> <tr><td colspan="2" style="text-align: center;">6 mm</td></tr> </table>	<b>J-25-1355</b>	15 cm	<b>J-25-1356</b>	18 cm	<b>J-25-1357</b>	20 cm	6 mm		 <table border="0"> <tr><td><b>J-25-1385</b></td><td>15 cm</td></tr> <tr><td><b>J-25-1386</b></td><td>18 cm</td></tr> <tr><td><b>J-25-1387</b></td><td>20 cm</td></tr> <tr><td colspan="2" style="text-align: center;">6 mm</td></tr> </table>	<b>J-25-1385</b>	15 cm	<b>J-25-1386</b>	18 cm	<b>J-25-1387</b>	20 cm	6 mm	
<b>J-25-1325</b>	15 cm																									
<b>J-25-1326</b>	18 cm																									
<b>J-25-1327</b>	20 cm																									
6 mm																										
<b>J-25-1355</b>	15 cm																									
<b>J-25-1356</b>	18 cm																									
<b>J-25-1357</b>	20 cm																									
6 mm																										
<b>J-25-1385</b>	15 cm																									
<b>J-25-1386</b>	18 cm																									
<b>J-25-1387</b>	20 cm																									
6 mm																										

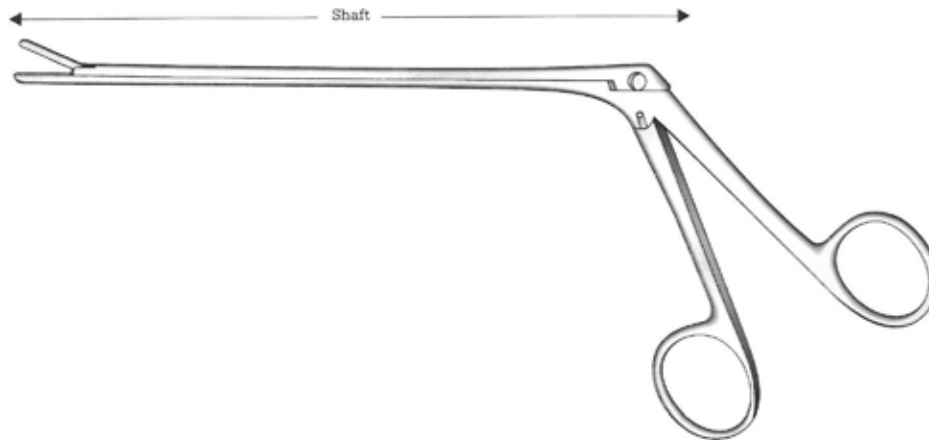

**Spurling**  
**J-25-680** 12 cm  
**J-25-681** 15 cm  
**J-25-682** 18 cm  
 4 x 10 mm  
 Straight

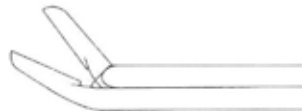

**Spurling**  
**J-25-683** 12 cm  
**J-25-684** 15 cm  
**J-25-685** 18 cm  
 4 x 10 mm  
 Angled at 45°  
 Upward



**Spurling**  
**J-25-686** 12 cm  
**J-25-687** 15 cm  
**J-25-688** 18 cm  
 4 x 10 mm  
 Angled at 45°  
 Downward

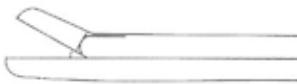

**Love Gruenwald**  
**J-25-689** 12 cm  
**J-25-690** 15 cm  
**J-25-691** 18 cm  
 3 x 10 mm  
 Straight



**Love Gruenwald**  
**J-25-692** 12 cm  
**J-25-693** 15 cm  
**J-25-694** 18 cm  
 3 x 10 mm  
 Angled at 45°  
 Upward

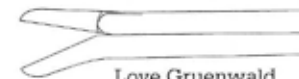

**Love Gruenwald**  
**J-25-695** 12 cm  
**J-25-696** 15 cm  
**J-25-697** 18 cm  
 3 x 10 mm  
 Angled at 45°  
 Downward



**Cushing**  
**J-25-698** 12 cm  
**J-25-699** 15 cm  
**J-25-700** 18 cm  
 2 x 10 mm  
 Straight

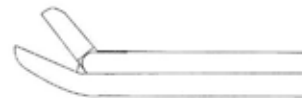

**Cushing**  
**J-25-701** 12 cm  
**J-25-702** 15 cm  
**J-25-703** 18 cm  
 2 x 10 mm  
 Angled at 45°  
 Upward

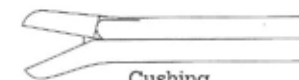

**Cushing**  
**J-25-704** 12 cm  
**J-25-705** 15 cm  
**J-25-706** 18 cm  
 2 x 10 mm  
 Angled at 45°  
 Downward

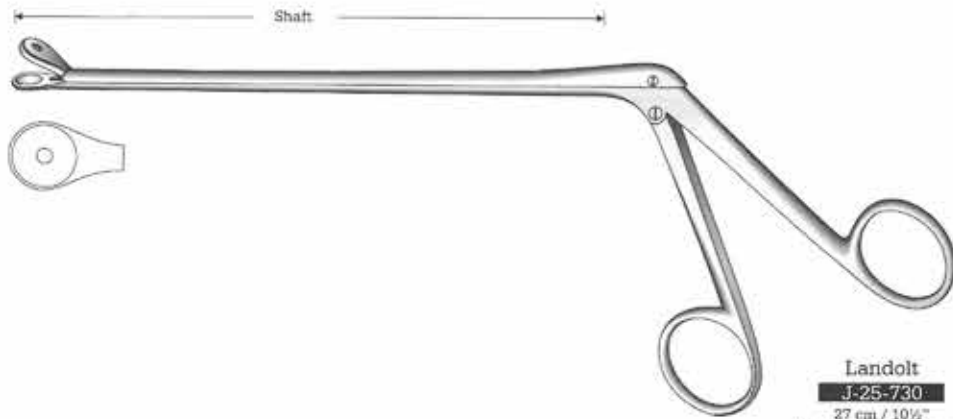

**Landolt**  
**J-25-730**  
 27 cm / 10½"  
 Tumor grasping forceps  
 Length of shaft: 20 cm / 8", blunt

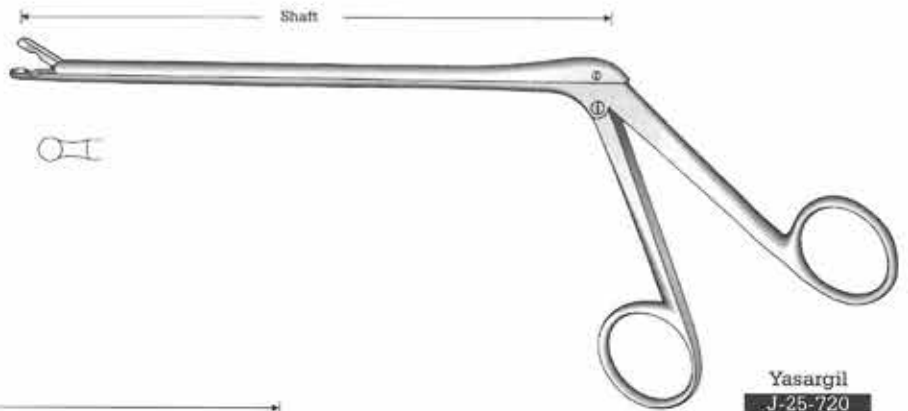

**Yasargil**  
**J-25-720**  
 25 cm / 10"  
 Pituitary rongeur  
 Length of shaft: 16 cm / 7", sharp

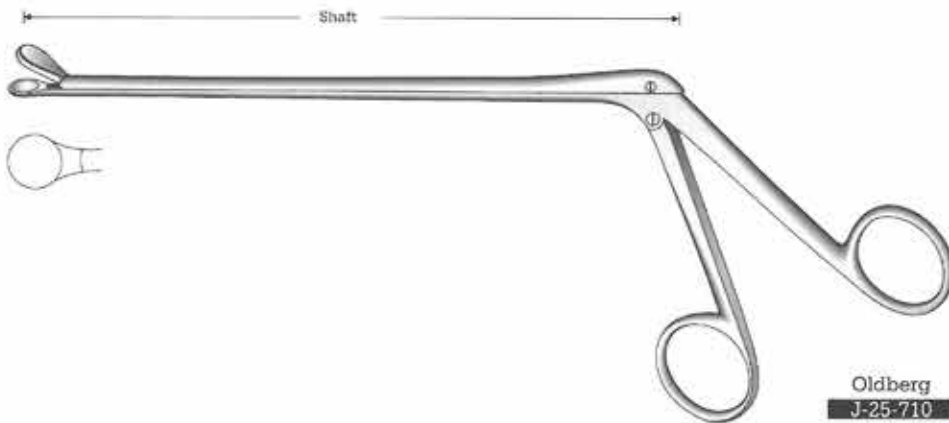

**Oldberg**  
**J-25-710**  
 25 cm / 10"  
 Length of shaft: 18 cm / 7"