



GYNECOLOGY



www.convertualinterlogic.com



+234 8033200998
+234 8180003461



enquiries@convertualinterlogic.com



1 Anu Crescent, Off Ado-Badore Road,
Ajah, Lagos, Nigeria



Cusco
J-20-100 75 x 32 mm
J-20-101 88 x 35 mm
J-20-102 100 x 37 mm
 Central screw, swiss pattern



Cusco
J-20-103 80 x 22 mm
J-20-104 100 x 25 mm
J-20-105 105 x 27 mm
 Swiss pattern



Cusco
J-20-2000 75 x 32 mm
J-20-2002 85 x 35 mm
J-20-2005 100 x 37 mm
 With close end.



Cusco
J-20-106
 75 x 17 mm

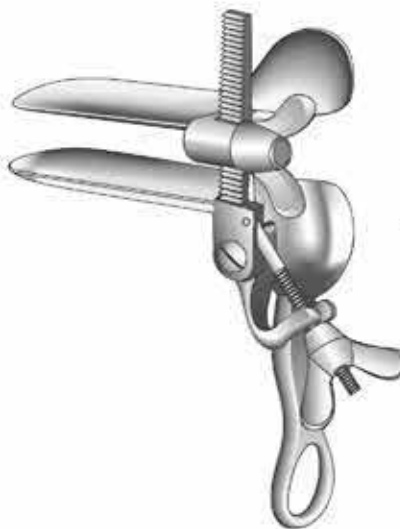

Trelat
J-20-107 85 x 33 mm
J-20-108 95 x 35 mm
J-20-109 115 x 43 mm



Cusco
 Japanese model
J-20-2010 Small
J-20-2015 Medium
J-20-2020 Large
 Stainless steel forged handle
J-20-2030 Small
J-20-2035 Medium
J-20-2040 Large
 Stainless steel sheet handle

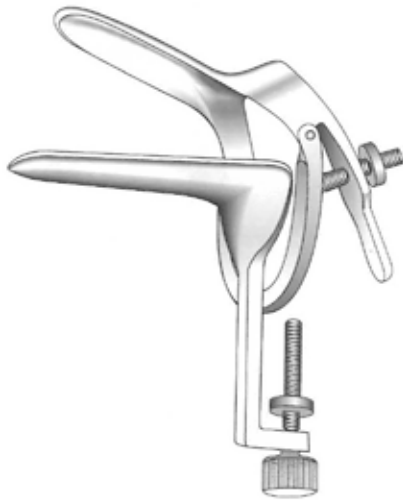

Clum
J-20-421
 Sakurai's vaginal speculum



Cusco
J-20-2050 Small
J-20-2055 Medium
J-20-2060 Large

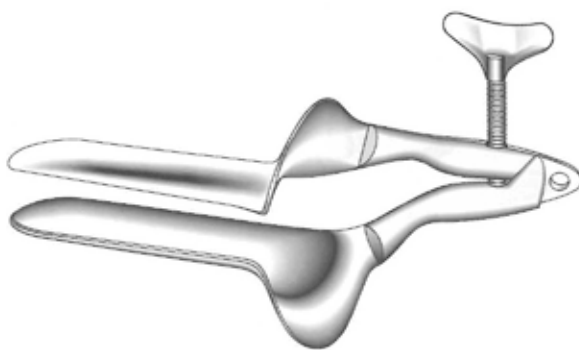

Collin
J-20-110 85 x 30 mm
J-20-111 100 x 35 mm
J-20-112 110 x 40 mm
 German sizes
J-20-2070 16 x 90 mm
J-20-2075 26 x 90 mm
J-20-2080 30 x 90 mm
J-20-2085 32 x 105 mm
J-20-2090 35 x 105 mm
J-20-2095 38 x 105 mm
 French sizes

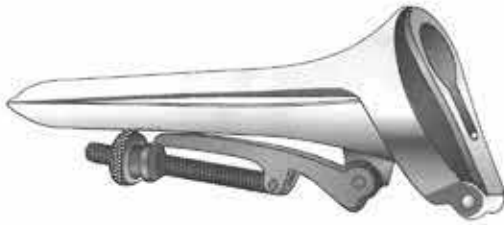

Cusco Pliant

| | |
|----------|-------------|
| J-20-910 | 16 x 100 mm |
| J-20-911 | 20 x 100 mm |
| J-20-912 | 25 x 100 mm |
| J-20-913 | 28 x 100 mm |
| J-20-914 | 30 x 100 mm |
| J-20-915 | 32 x 100 mm |
| J-20-916 | 36 x 100 mm |



Cusco Fixe

| | |
|----------|-------------|
| J-20-920 | 16 x 100 mm |
| J-20-921 | 25 x 100 mm |
| J-20-922 | 32 x 100 mm |
| J-20-923 | 35 x 100 mm |
| J-20-924 | 40 x 100 mm |

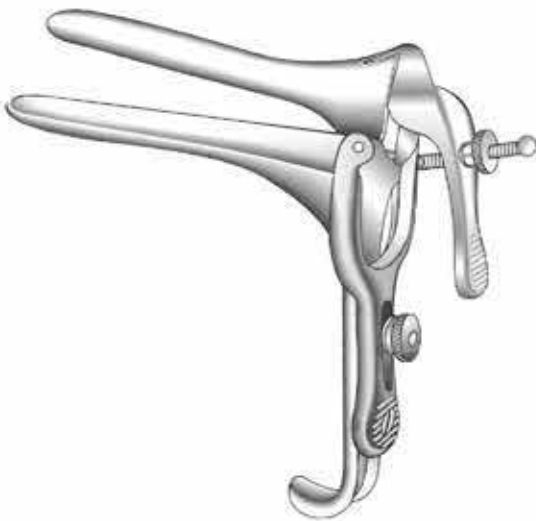

Poderson

| | |
|----------|-------------|
| J-20-113 | 75 x 13 mm |
| J-20-114 | 100 x 22 mm |
| J-20-115 | 120 x 25 mm |

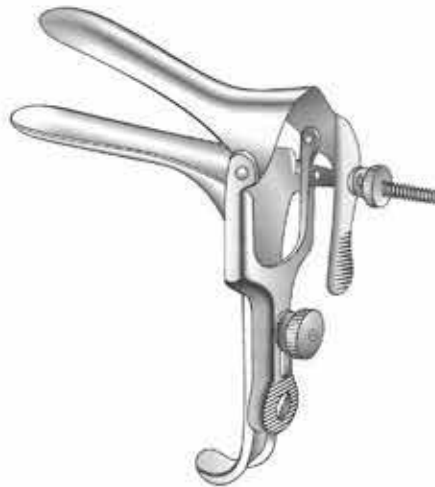

Grave

| | |
|----------|-------------|
| J-20-116 | 75 x 20 mm |
| J-20-117 | 95 x 35 mm |
| J-20-118 | 115 x 35 mm |

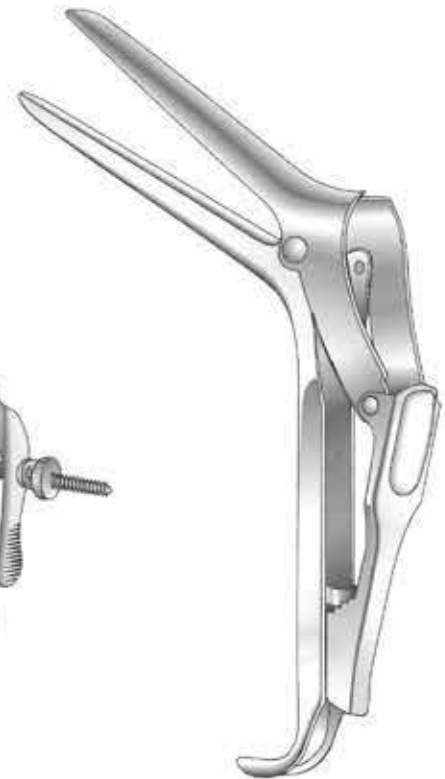

Semm

| | |
|----------|------------------|
| J-20-119 | 100 x 17 / 20 mm |
| J-20-120 | 100 x 25 / 30 mm |

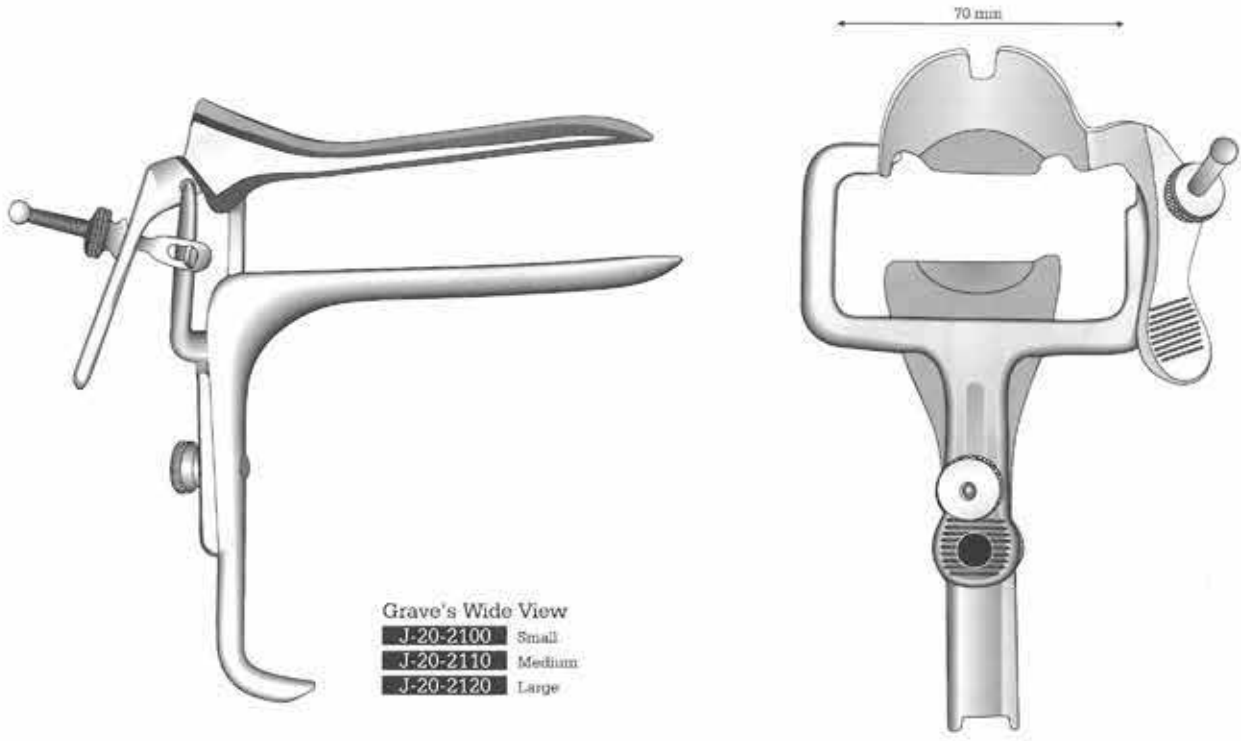

VU-More
 Grave



VU-More
 J-20-465 Small
 J-20-466 Medium
 J-20-467 Large



Collin
 J-20-121
 65 x 10 mm



Grave
J-20-425 76 x 13 mm
J-20-426 101 x 22 mm
J-20-427 120 x 35 mm
 Suction tube on upper blade

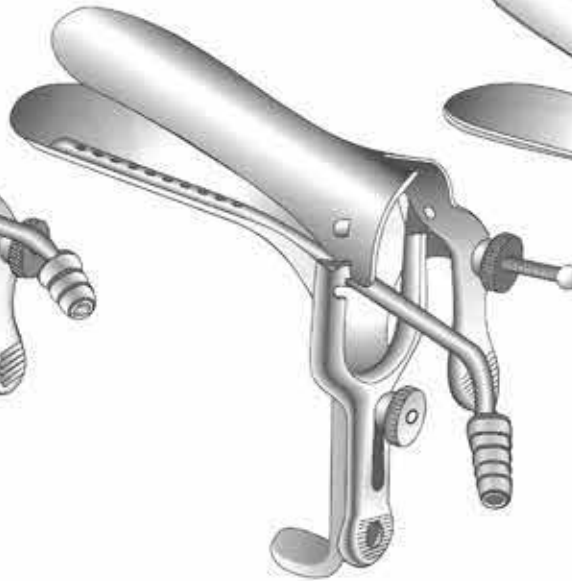

Grave
J-20-428 76 x 13 mm
J-20-429 101 x 22 mm
J-20-430 120 x 35 mm
 Suction tube on lower blade

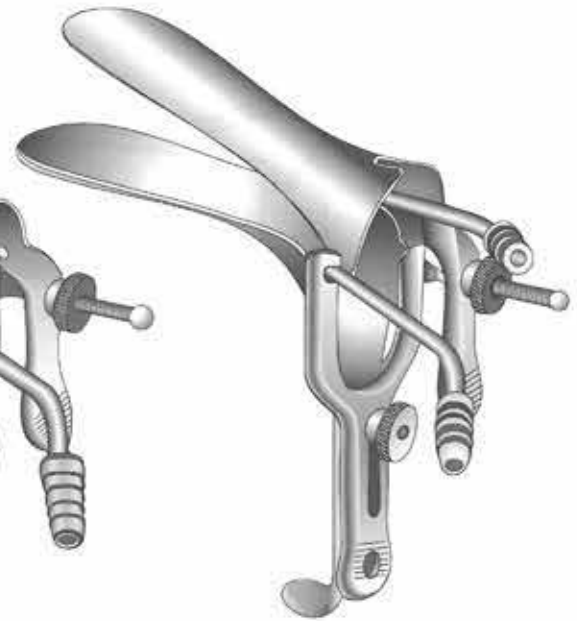

Grave
J-20-431 76 x 13 mm
J-20-432 101 x 22 mm
J-20-433 120 x 35 mm
 Suction tubes on lower & upper blade

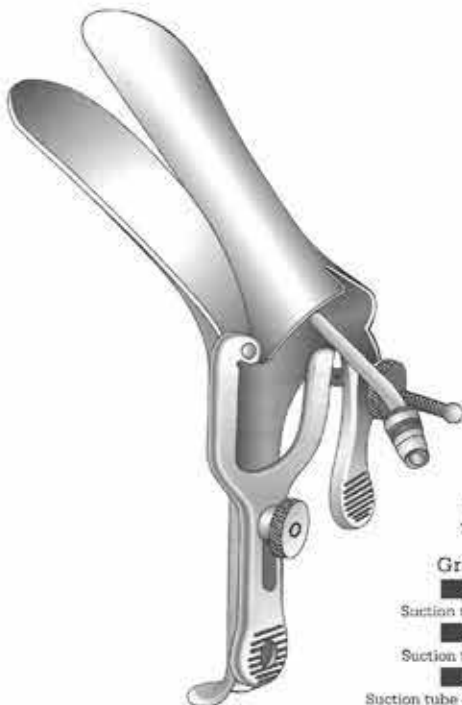

135° angled
101 x 35 mm
Grave Special
J-20-434
 Suction tube on upper blade
J-20-435
 Suction tube on lower blade
J-20-436
 Suction tube on upper & lower blades

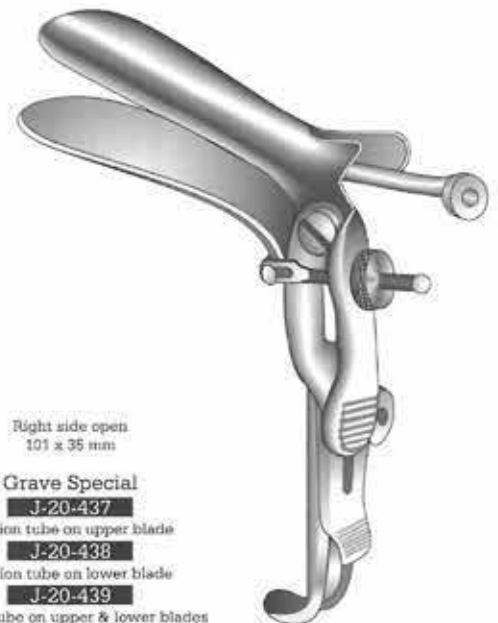

Right side open
101 x 35 mm
Grave Special
J-20-437
 Suction tube on upper blade
J-20-438
 Suction tube on lower blade
J-20-439
 Suction tube on upper & lower blades

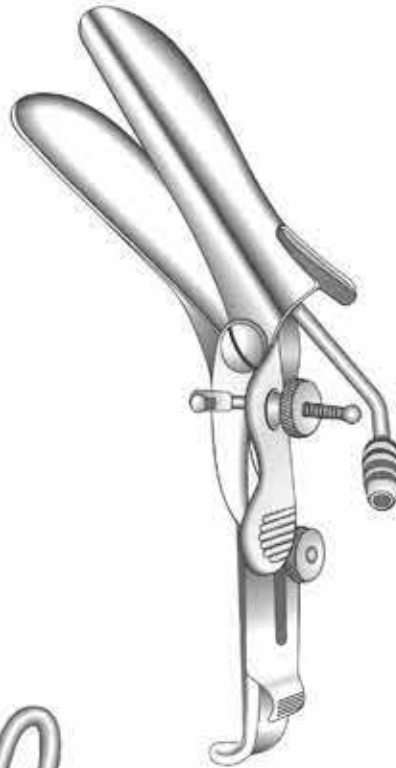

135° angled & right side open
101 x 35 mm

Grave Special

J-20-440

Suction tube on upper blade

J-20-441

Suction tube on lower blade

J-20-442

Suction tube on upper & lower blades

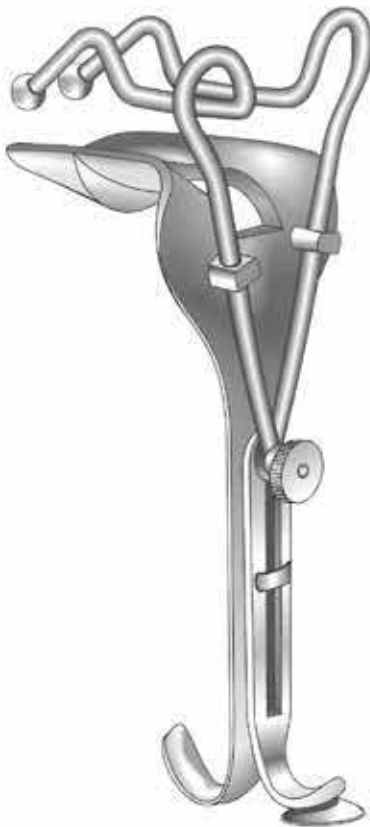

Guttmann
J-20-2140
80 x 45 mm



Guttmann
J-20-2150
90 x 35 mm

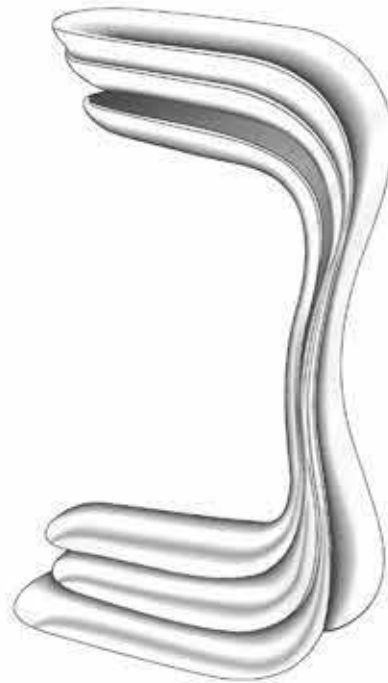

Sims

| | |
|-----------------|------------------------|
| J-20-122 | 65 x 25 mm, 75 x 30 mm |
| J-20-123 | 70 x 30 mm, 70 x 35 mm |
| J-20-124 | 85 x 35 mm, 90 x 40 mm |

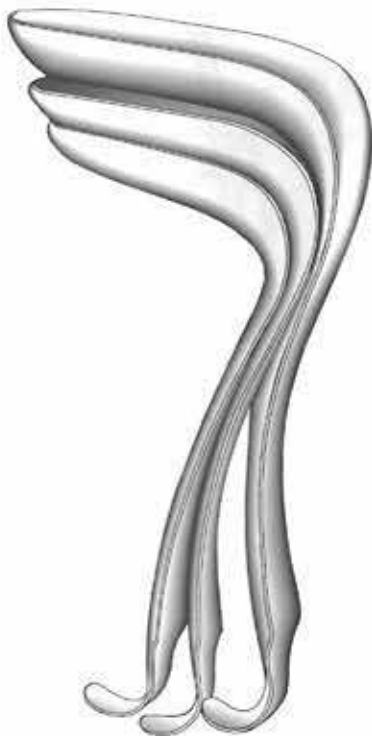

Kristeller

| | |
|-----------------|------------|
| J-20-127 | 70 x 27 mm |
| J-20-128 | 80 x 30 mm |
| J-20-129 | 90 x 36 mm |

Specula



Kristeller

| | |
|-----------------|-------------|
| J-20-130 | 75 x 23 mm |
| J-20-131 | 85 x 26 mm |
| J-20-132 | 100 x 32 mm |

Retractors



Kristeller

| | |
|------------------|---------------------|
| J-20-2160 | J-20-127 & J-20-130 |
| J-20-2165 | J-20-128 & J-20-131 |
| J-20-2170 | J-20-129 & J-20-132 |

Set of 1 speculum and 1 retractor

Gynecology

Vaginal Specula and Retractors

Scheidenspekula und halter

Especulos Y Valvas Vaginales



Conically shaped blades, virgin sizes

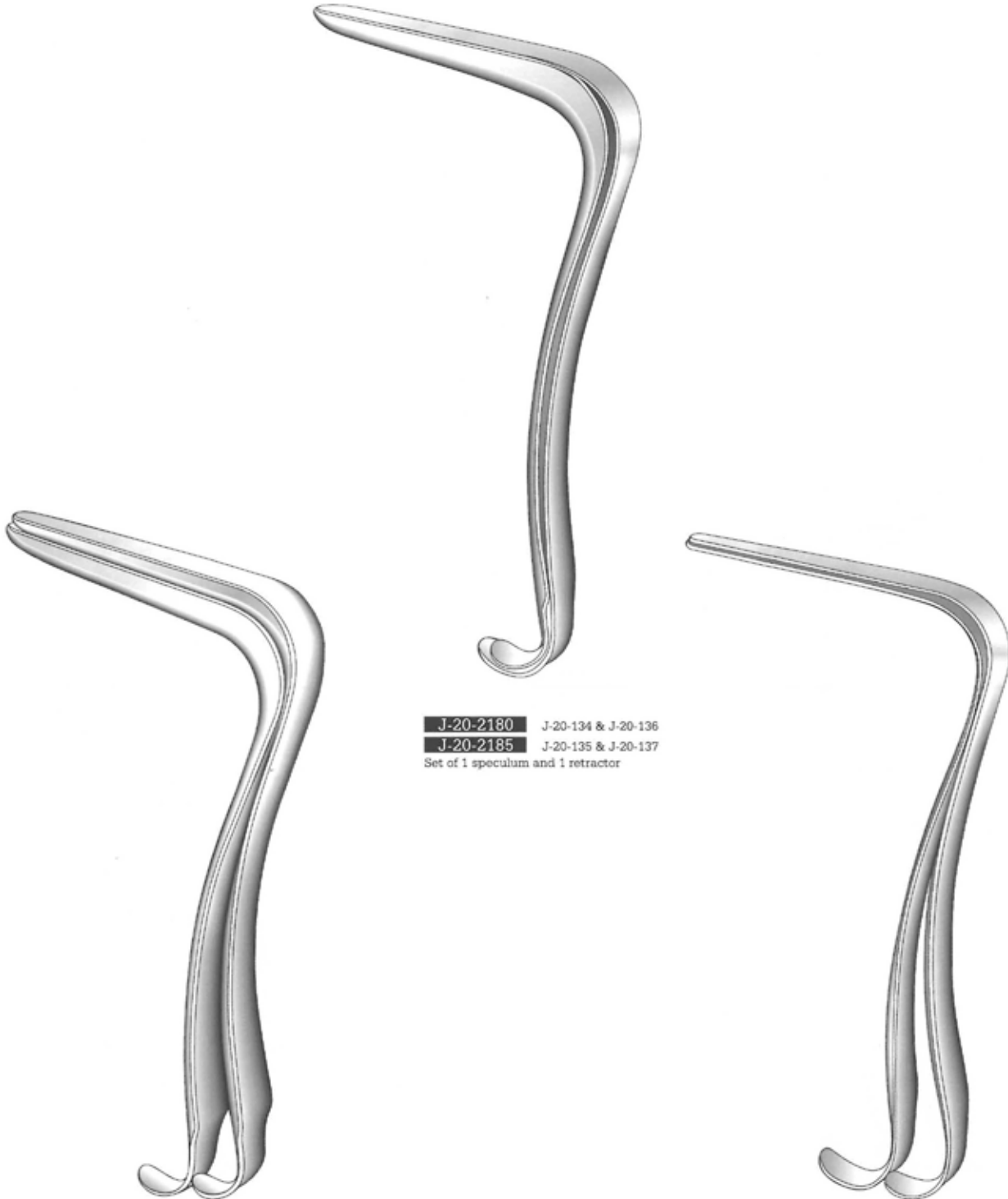

J-20-2180 J-20-134 & J-20-136
J-20-2185 J-20-135 & J-20-137
Set of 1 speculum and 1 retractor

Kristeller
J-20-134 105 x 18 mm
J-20-135 105 x 21 mm
Specula

Kristeller
J-20-136 110 x 14 mm
J-20-137 110 x 17 mm
Retractors

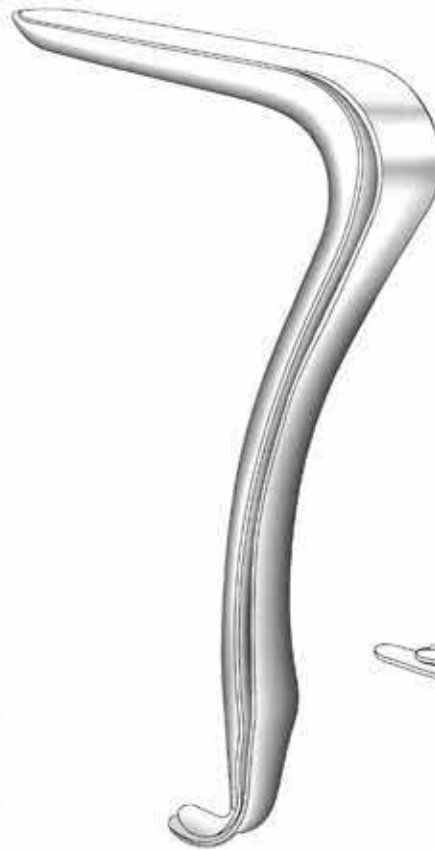

Kristeller
J-20-2200 J-20-139 & J-20-142
J-20-2205 J-20-140 & J-20-143
J-20-2210 J-20-141 & J-20-144
 Set of 1 speculum and 1 retractor

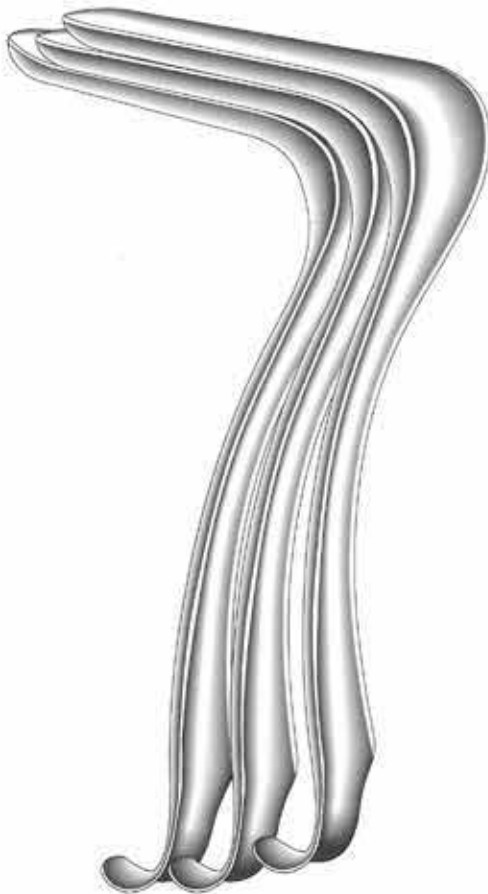

Kristeller
J-20-139 105 x 26 mm
J-20-140 105 x 28 mm
J-20-141 105 x 33 mm
 Specula

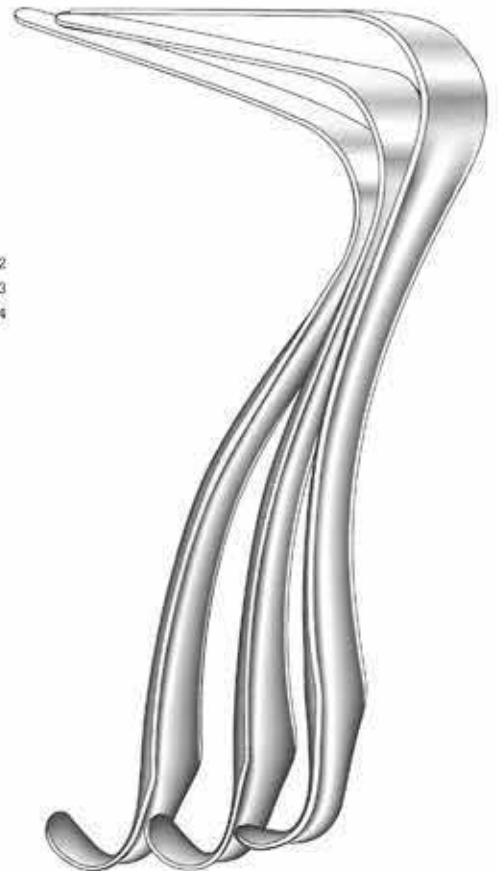

Kristeller
J-20-142 115 x 22 mm
J-20-143 115 x 24 mm
J-20-144 115 x 29 mm
 Retractors

Gynecology

Vaginal Specula and Retractors

Scheidenspekula und halter

Especulos Y Valvas Vaginales

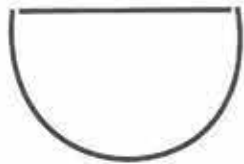

Specula deep hollow

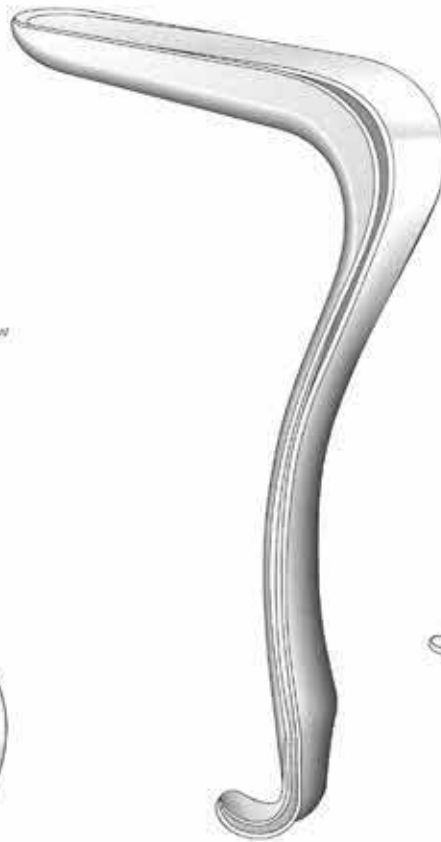

Kristeller

| | |
|-----------|---------------------|
| J-20-2220 | J-20-146 & J-20-149 |
| J-20-2225 | J-20-147 & J-20-150 |
| J-20-2230 | J-20-148 & J-20-151 |

Set of 1 speculum and 1 retractor

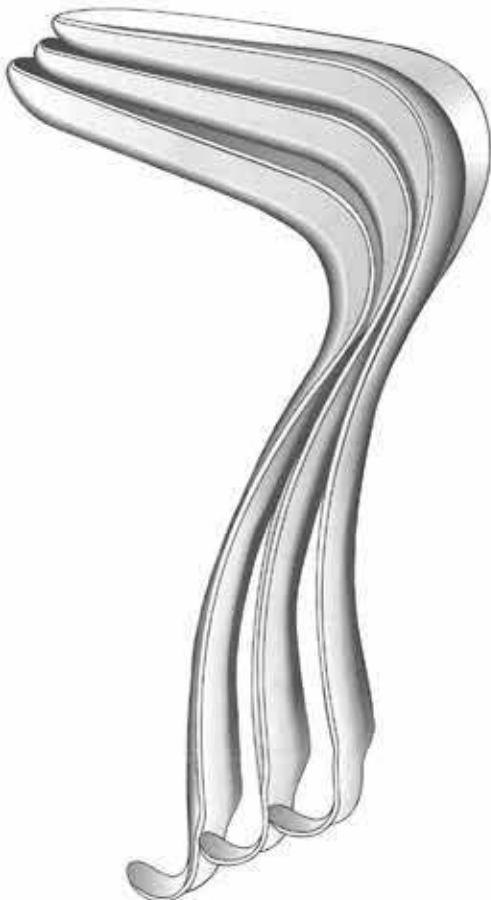

Kristeller

| | |
|----------|-------------|
| J-20-146 | 110 x 27 mm |
| J-20-147 | 110 x 30 mm |
| J-20-148 | 110 x 36 mm |

Specula

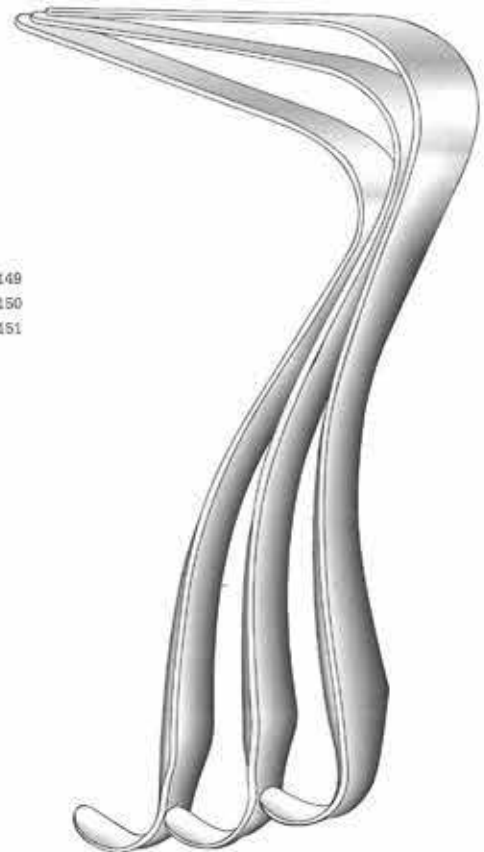

Kristeller

| | |
|----------|-------------|
| J-20-149 | 115 x 23 mm |
| J-20-150 | 115 x 26 mm |
| J-20-151 | 115 x 32 mm |

Retractors



Doyen
 Slightly-Concave
J-20-153

| | |
|------------------|-------------|
| J-20-2250 | 65 x 35 mm |
| J-20-2255 | 85 x 35 mm |
| J-20-2260 | 115 x 35 mm |
| J-20-2265 | 65 x 45 mm |
| J-20-2270 | 85 x 45 mm |
| J-20-2275 | 115 x 45 mm |
| J-20-2280 | 160 x 45 mm |
| J-20-2285 | 55 x 60 mm |
| J-20-2290 | 85 x 60 mm |
| J-20-2295 | 115 x 60 mm |
| J-20-2300 | 160 x 60 mm |

Slightly-concave

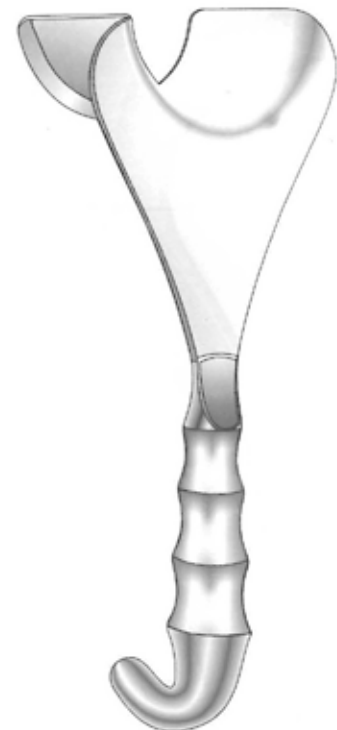

De Lee Universal Retractor
J-20-187
 24 cm / 9½"
 Blade 2½" x 2"

Gynecology

Vaginal Specula and Retractors

Scheidenspekula und halter

Especulos Y Valvas Vaginales



Jackson
J-20-154
75 x 38 mm

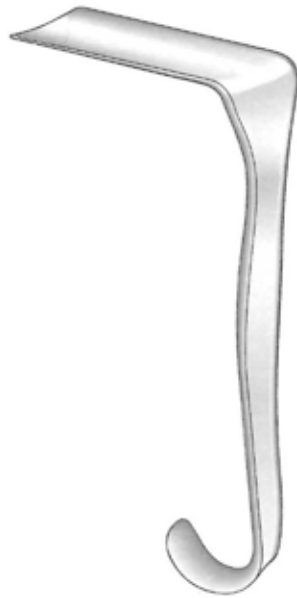

Jackson
J-20-155
90 x 38 mm



Jackson
J-20-156
100 x 38 mm



Sims
J-20-2310
Single ended
J-20-2320 Small, 2 1/4" x 1"
J-20-2325 Medium, 3" x 1 1/4"
J-20-2330 Large, 3 1/2" x 1 1/4"



Kallmorgen
J-20-158 70 x 40 mm
J-20-159 80 x 40 mm
 Vaginal specula



Kallmorgen
J-20-160
J-20-161
 Vaginal retractors
J-20-2360 J-20-158 & J-20-160
J-20-2361 J-20-159 & J-20-161
 Kallmorgen sets



Mathieu
J-20-162 95 x 16 mm
 95 x 25 mm
J-20-163 95 x 16 mm
 95 x 30 mm
 Vaginal specula



J-20-166 100 x 16 mm
 100 x 20 mm
J-20-167 100 x 14 mm
 100 x 26 mm
 Vaginal retractors

Gynecology

Vaginal Specula and Retractors

Scheidenspekula Und-Halter

Especulos Y Valvas Vaginales



Breisky

| | |
|----------|-------------|
| J-20-171 | 100 x 20 mm |
| J-20-172 | 100 x 25 mm |
| J-20-173 | 100 x 30 mm |
| J-20-174 | 100 x 35 mm |
| J-20-175 | 100 x 40 mm |
| J-20-176 | 130 x 20 mm |
| J-20-177 | 130 x 25 mm |
| J-20-178 | 130 x 30 mm |
| J-20-179 | 130 x 35 mm |
| J-20-180 | 130 x 40 mm |
| J-20-181 | 155 x 40 mm |



Doyen

J-20-182
70 x 30 mm



Auvard

J-20-2380 Light 2 lbs.
J-20-2385 Medium 2½ lbs.
J-20-2390 Heavy 3 lbs.
Weighted vaginal speculum
Blades 2¼" x 1½"



Garrigue

J-20-2400 Light 2 lbs.
J-20-2405 Medium 2½ lbs.
J-20-2410 Heavy 3 lbs.
Weighted vaginal speculum
Blades 3" x 1½"



Henrotin

J-20-190
3 lbs.
Blade 3¼" x 1½"
Weighted vaginal speculum



Berlind-Auvard

J-20-191
2½ lbs.
Weighted vaginal speculum



Steiner-Auvard

J-20-192
2½ lbs.
Weighted vaginal speculum



Jayle
J-20-2430 60 x 40 mm, 60 x 40 mm
J-20-2435 90 x 40 mm, 90 x 40 mm
Blade with weight

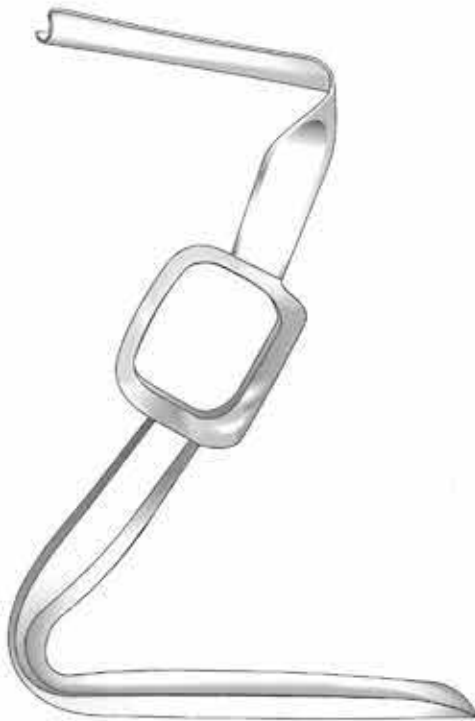

Soonawala
Vaginal specula
J-20-2440
Stainless steel

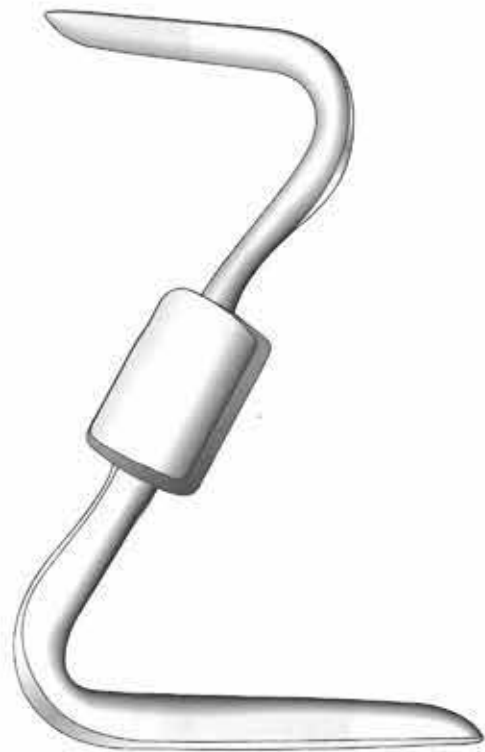

Soonawia Modified
Vaginal specula
J-20-2450
Stainless steel

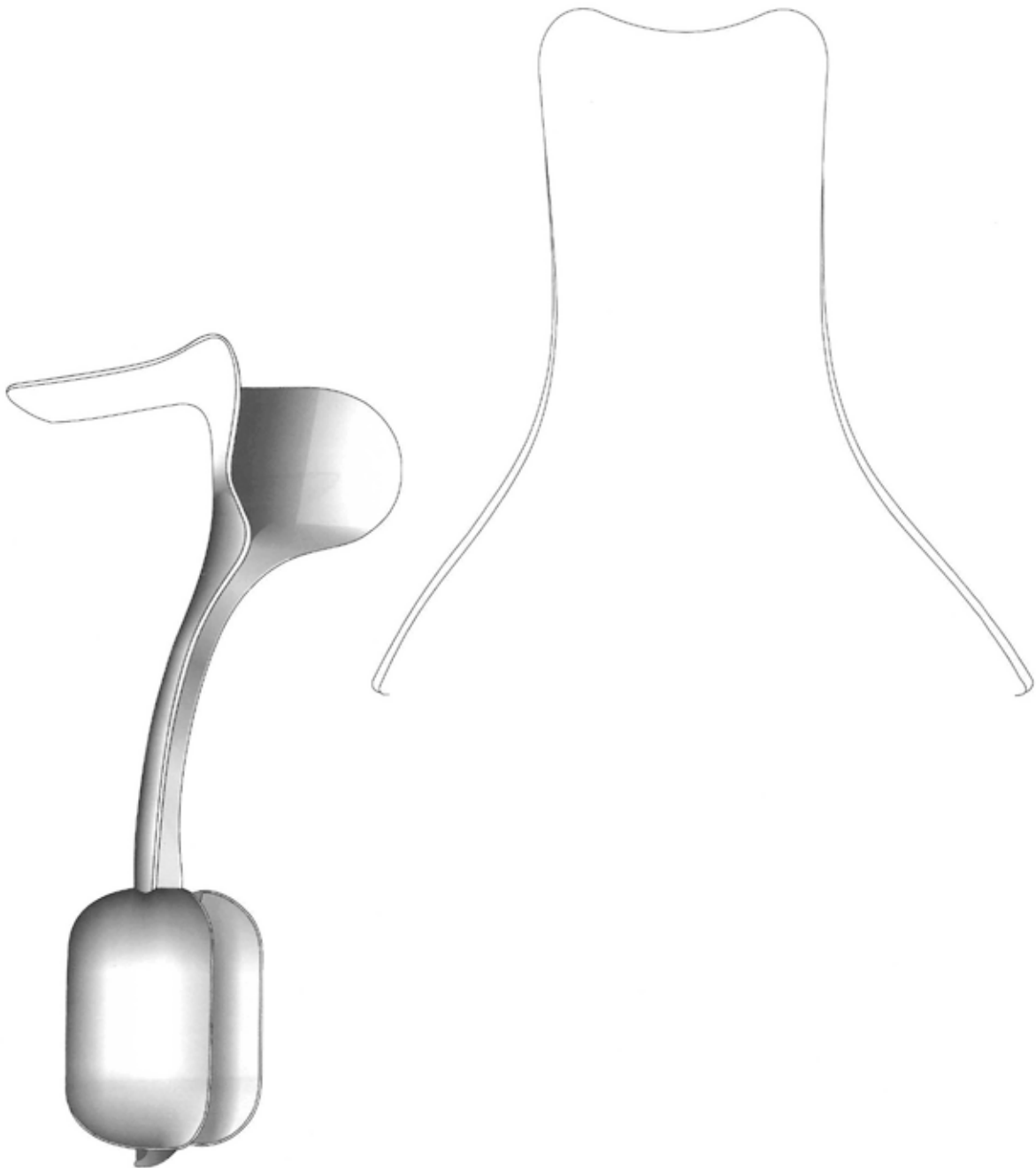

Auvard
J-20-193
80 x 43 mm
Complete with removable weight



J-20-931
 80 x 30 mm
 Blade only



J-20-932
 85 x 35 mm
 Blade only



J-20-934
 55 x 40, 60 mm
 Blade only



J-20-933
 85 x 40 mm
 Blade only



J-20-935
 70 x 45, 70 mm
 Blade only

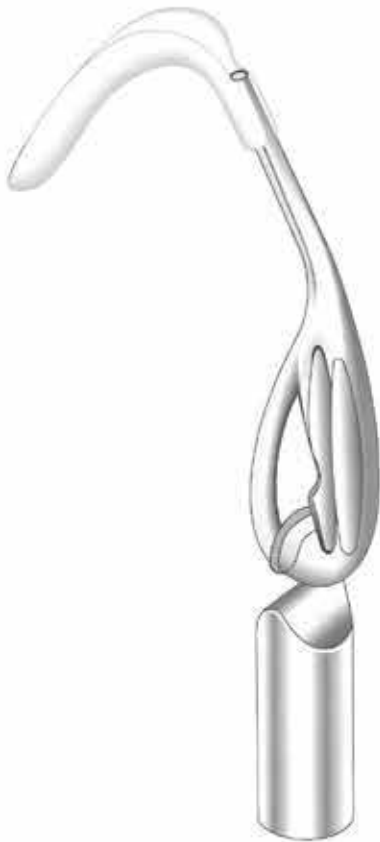

Scherback

J-20-950

Set, consisting of
 Handle (J-20-940)
 Weight (J-20-930)
 5 blades (J-20-931 - J-20-935)

J-20-940

Handle for vaginal speculum

J-20-930

Weight for vaginal speculum



J-20-961
80 x 30 mm



J-20-971
65 x 30 mm



J-20-962
85 x 33 mm



J-20-972
75 x 35 mm



J-20-963
100 x 38 mm



J-20-973
85 x 35 mm



J-20-964
110 x 42 mm



J-20-974
95 x 35 mm



Bozemann
J-20-960
23 cm / 9"



Bozemann
J-20-970
22 cm / 8 3/4"

Bozemann
J-20-959
Set, consisting of
2 handle (J-20-960, J-20-970)
8 blades (J-20-961 - J-20-974)



Lateral vaginal retractor
J-20-370
 Ratchet handle

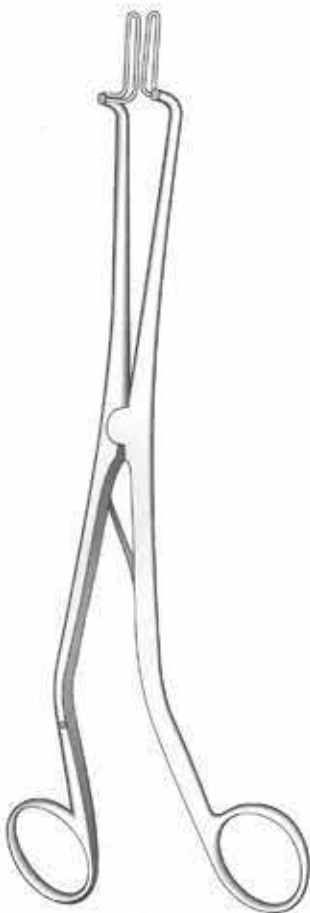

Kogan
J-20-196
 24 cm / 9½"

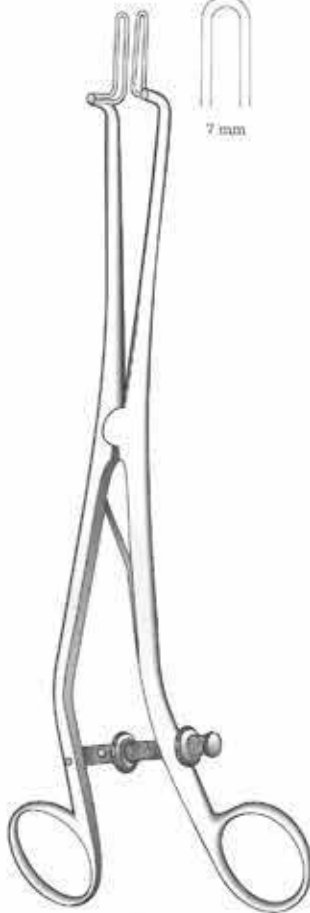

Kogan
J-20-195
 24 cm / 9½"



Kogan
J-20-2455
 28 cm / 11"



Lateral Vaginal Retractor
 Blade size
J-20-2460 60 x 22 mm
J-20-2465 80 x 22 mm
J-20-2470 100 x 22 mm
J-20-2475 120 x 22 mm
 With ratchet handle

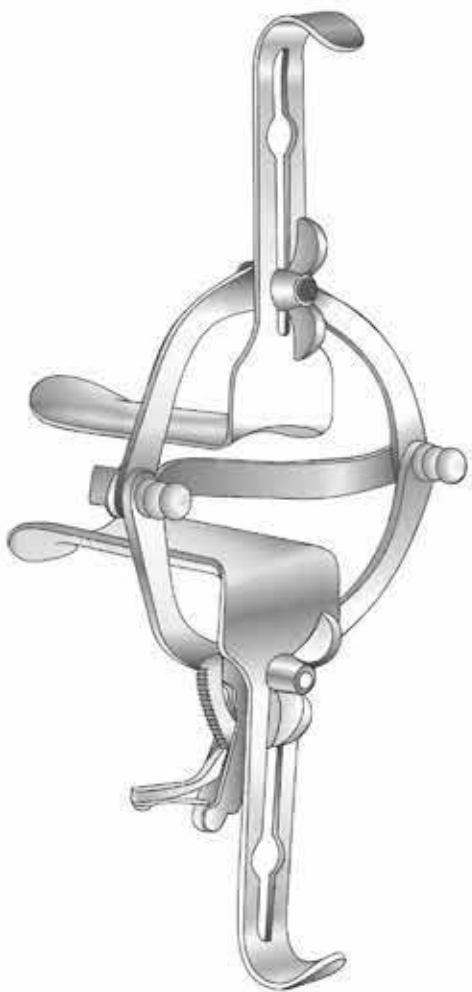

O' Sullivan-O' Connor
 J-20-2490

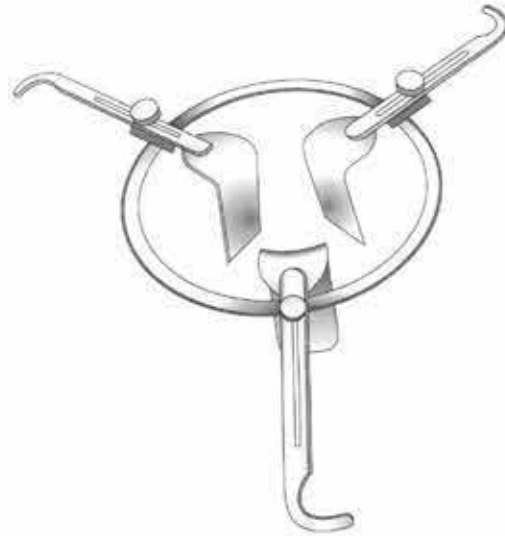

Smith
 J-20-379

Vaginal retractor self-retaining provides adequate exposure for the obstetrical to work on the ante- or postmortem cervix without an assistant. Stainless steel ring is 23 cm / 9" in diameter. Three identical stainless steel right angled retractors with blades 4.4 cm / 1 1/4" wide by 10.2 cm / 4" deep, have 20.3 cm / 8" handles, and may be placed anywhere around the ring. The angle and counter traction of the blades serve to hold the retractor securely in place.



J-20-2510
 45 x 17 mm
 Fig. 1



J-20-2515
 90 x 37 mm
 Fig. 2



J-20-2520
 90 x 45 mm
 Fig. 3

Gynecology

Wound Spreader, Self-retaining

Wundspreizer

Separadores autoestaticos



Friedman

J-20-170

10 cm / 4"

J-20-4470

13 cm / 5"

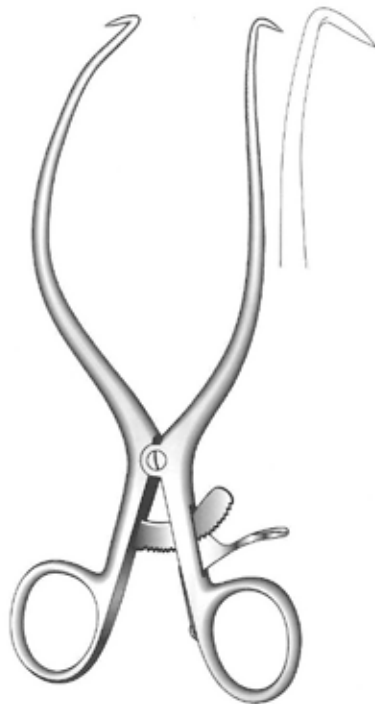

Gelpi

J-19-311 9 cm / 3½"

J-19-312 11.5 cm / 4½"

J-19-313 14 cm / 5½"

J-19-314 16 cm / 6¼"

J-19-315 18 cm / 7"

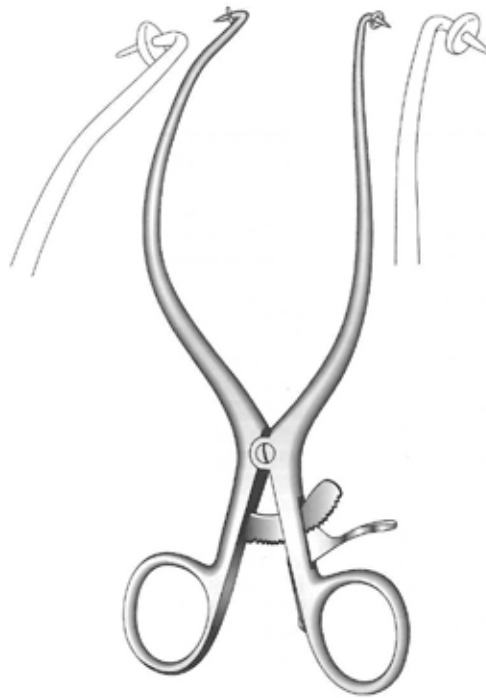

Gelpi

J-19-316

18 cm / 7"



Rigby

J-19-317

18 cm / 7"

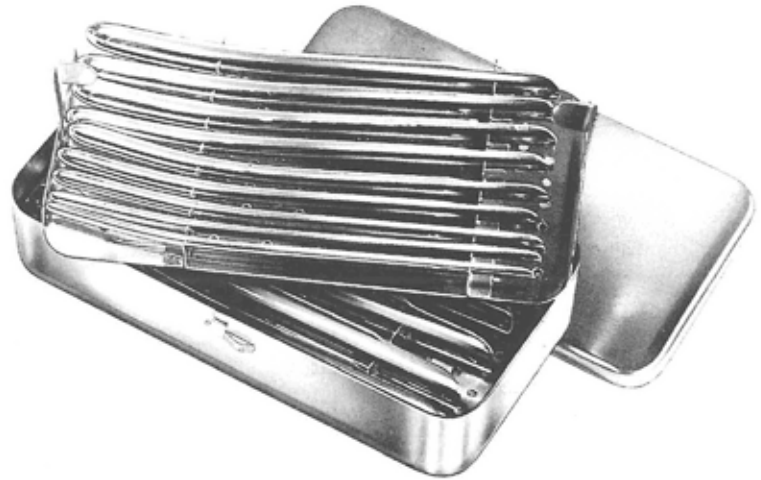

J-20-248 Brass
J-20-4525 Stainless steel
 Set of 14 pieces
 4 mm to 17 mm



| | | |
|-----------------|-------|------------------|
| J-20-198 | 1 mm | J-20-4570 |
| J-20-200 | 2 mm | J-20-4571 |
| J-20-202 | 3 mm | J-20-4572 |
| J-20-204 | 4 mm | J-20-4573 |
| J-20-206 | 5 mm | J-20-4574 |
| J-20-208 | 6 mm | J-20-4575 |
| J-20-210 | 7 mm | J-20-4576 |
| J-20-212 | 8 mm | J-20-4577 |
| J-20-214 | 9 mm | J-20-4578 |
| J-20-215 | 10 mm | J-20-4579 |
| J-20-217 | 11 mm | J-20-4580 |
| J-20-219 | 12 mm | J-20-4581 |
| J-20-221 | 13 mm | J-20-4582 |
| J-20-223 | 14 mm | J-20-4583 |
| J-20-225 | 15 mm | J-20-4584 |
| J-20-227 | 16 mm | J-20-4585 |
| J-20-229 | 17 mm | J-20-4586 |
| J-20-231 | 18 mm | J-20-4587 |
| J-20-233 | 19 mm | J-20-4588 |
| J-20-235 | 20 mm | J-20-4589 |
| J-20-237 | 21 mm | J-20-4590 |
| J-20-239 | 22 mm | J-20-4591 |
| J-20-241 | 23 mm | J-20-4592 |
| J-20-243 | 24 mm | J-20-4593 |
| J-20-245 | 25 mm | J-20-4594 |
| J-20-247 | 26 mm | J-20-4595 |

Brass

Stainless steel



Hawkins-Amber
J-20-265
 Set of 16, 3 to 18
J-20-4565
 Set of 16, 6 to 21

Hegar

Uterine dilators, single ended
 with sloped handle

J-20-500 Brass

J-20-505 Stainless steel

Set of 26 pieces



| | | |
|-----------------|-----------|------------------|
| J-20-249 | Set of 13 | J-20-4649 |
| J-20-250 | 1/2 mm | J-20-4650 |
| J-20-251 | 3/4 mm | J-20-4651 |
| J-20-252 | 5/6 mm | J-20-4652 |
| J-20-253 | 7/8 mm | J-20-4653 |
| J-20-254 | 9/10 mm | J-20-4654 |
| J-20-255 | 11/12 mm | J-20-4655 |
| J-20-256 | 13/14 mm | J-20-4656 |
| J-20-257 | 15/16 mm | J-20-4657 |
| J-20-258 | 17/18 mm | J-20-4658 |
| J-20-259 | 19/20 mm | J-20-4659 |
| J-20-260 | 21/22 mm | J-20-4660 |
| J-20-261 | 23/24 mm | J-20-4661 |
| J-20-262 | 25/26 mm | J-20-4662 |
| Brass | | Stainless steel |



| | | |
|-----------------|--------------------|------------------|
| J-20-272 | Set of 8 | J-20-4672 |
| J-20-273 | Sizes 13/15 French | J-20-4673 |
| J-20-274 | Sizes 17/19 French | J-20-4674 |
| J-20-275 | Sizes 21/23 French | J-20-4675 |
| J-20-276 | Sizes 25/27 French | J-20-4676 |
| J-20-277 | Sizes 29/31 French | J-20-4677 |
| J-20-278 | Sizes 33/35 French | J-20-4678 |
| J-20-279 | Sizes 37/39 French | J-20-4679 |
| J-20-280 | Sizes 41/43 French | J-20-4680 |
| Brass | | Stainless steel |

Pratt
 Double ended
 26.5 cm / 10 1/2"

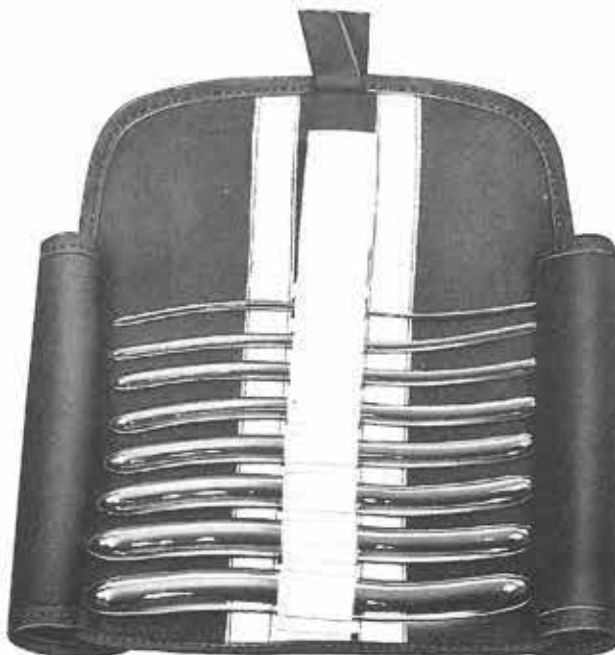

Hegar
 Double ended
 20 cm / 8"
 Available in canvas and synthetic pouch

| | |
|---|---|
| J-20-263 | J-20-4663 |
| Set of 8 dilators including J-20-251 -- J-20-258 | Set of 8 dilators including J-20-4651 -- J-20-4658 |
| Brass | Stainless steel |



| | Fr. | |
|-----------|-----|-----------|
| J-38-1821 | 08 | J-38-1460 |
| J-38-1822 | 09 | J-38-1470 |
| J-38-1823 | 10 | J-38-1480 |
| J-38-1824 | 11 | J-38-1490 |
| J-38-1825 | 12 | J-38-1500 |
| J-38-1826 | 13 | J-38-1510 |
| J-38-1827 | 14 | J-38-1520 |
| J-38-1828 | 15 | J-38-1530 |
| J-38-1829 | 16 | J-38-1540 |
| J-38-1830 | 17 | J-38-1550 |
| J-38-1831 | 18 | J-38-1560 |
| J-38-1832 | 19 | J-38-1570 |
| J-38-1833 | 20 | J-38-1580 |
| J-38-1834 | 21 | J-38-1590 |
| J-38-1835 | 22 | J-38-1600 |
| J-38-1836 | 23 | J-38-1610 |
| J-38-1837 | 24 | J-38-1620 |
| J-38-1838 | 25 | J-38-1630 |
| J-38-1839 | 26 | J-38-1640 |
| J-38-1840 | 27 | J-38-1650 |
| J-38-1841 | 28 | J-38-1660 |
| J-38-1842 | 29 | J-38-1670 |
| J-38-1843 | 30 | J-38-1680 |
| J-38-1844 | 31 | J-38-1690 |
| J-38-1845 | 32 | J-38-1700 |
| J-38-1846 | 33 | J-38-1710 |
| J-38-1847 | 34 | J-38-1720 |
| J-38-1848 | 35 | J-38-1730 |
| J-38-1849 | 36 | J-38-1740 |

With hole

Without hole



Guyon
 J-38-1450 with hole
 J-38-1451 without hole
 Set of 29, Fr. 8 - Fr. 36



Guyon
 J-20-165
 36.5 cm / 14 1/2"



Hegar
J-20-218
 Set of 13
 Fig. 1-13
 Stainless Steel
J-20-220
 Set of 13
 Fig. 1-13
 Chrome plated



Hank Set
J-20-2660 Canvas pouch
J-20-2665 Synthetic pouch
 Set of 6



J-20-266
 4.5/5 mm^Ø
 Fig. 9/10



J-20-267
 5.5/6 mm^Ø
 Fig. 11/12



J-20-268
 6.5/7 mm^Ø
 Fig. 13/14



J-20-269
 7.5/8 mm^Ø
 Fig. 15/16



J-20-270
 8.5/9 mm^Ø
 Fig. 17/18



J-20-271
 9.5/10 mm^Ø
 Fig. 19/20

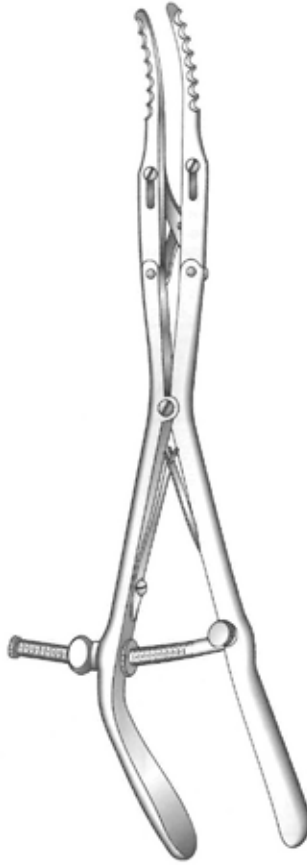

Goodell
J-20-2560
34 cm / 13½"

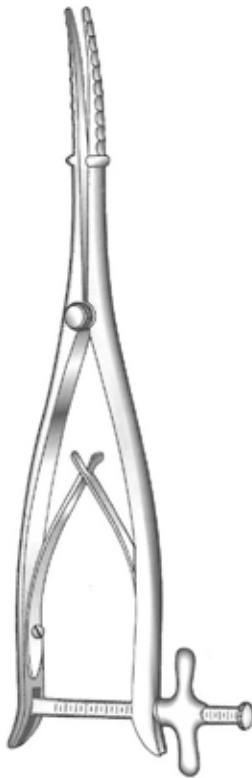

Wylie
J-20-2570
29 cm / 11½"

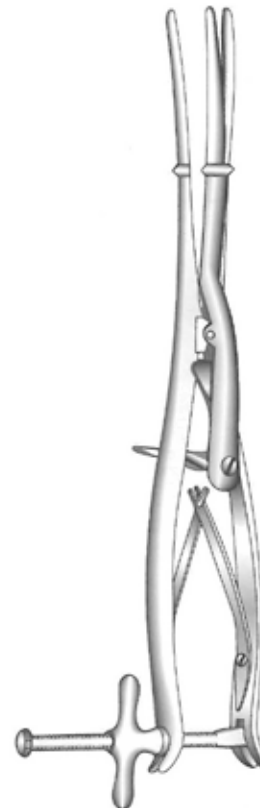

Sims
J-20-281
29 cm / 11½"

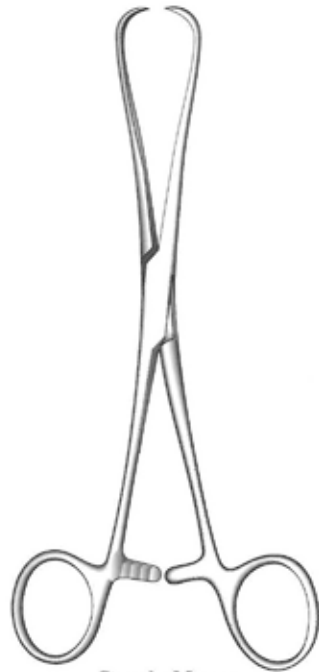

Staude-Moore
J-20-288
17 cm / 6 3/4"
Strong pattern

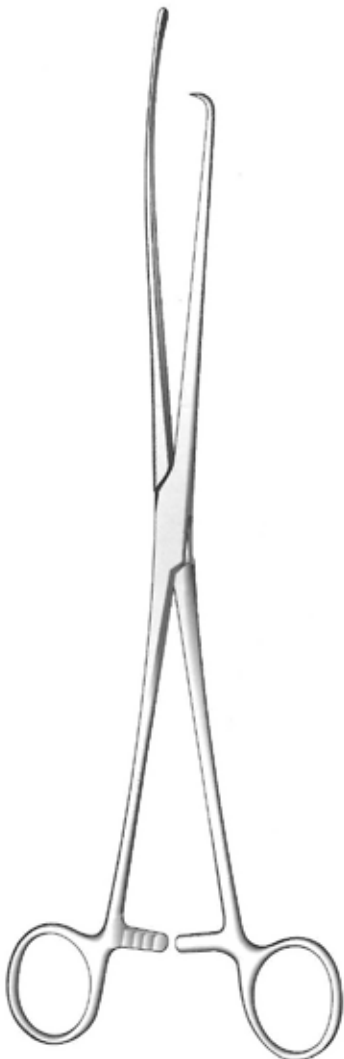

Hulka
J-20-2580
28 cm / 11"

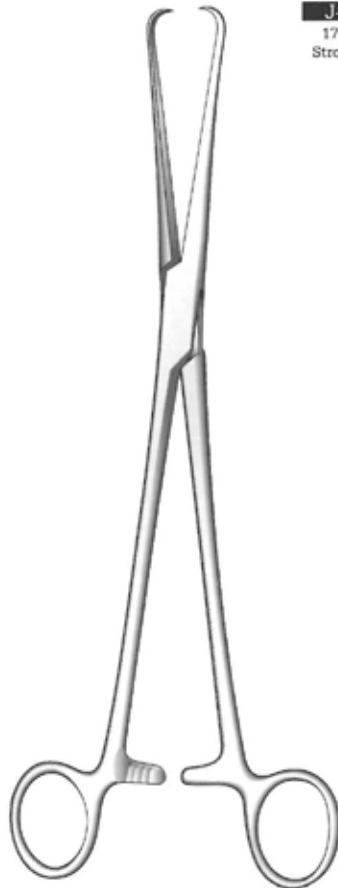

Pozzi
J-20-289
25.5 cm / 10 1/4"

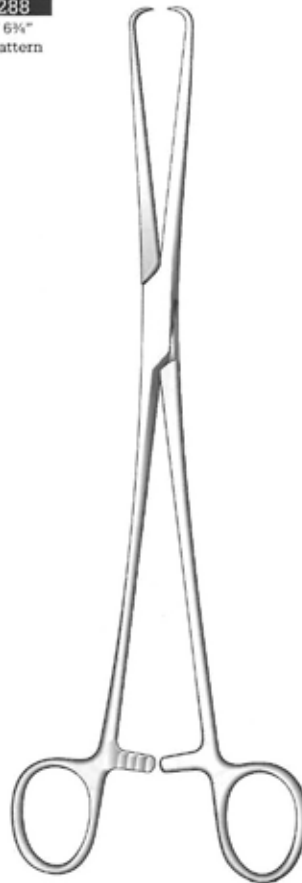

Schroeder
J-20-290
25 cm / 10"

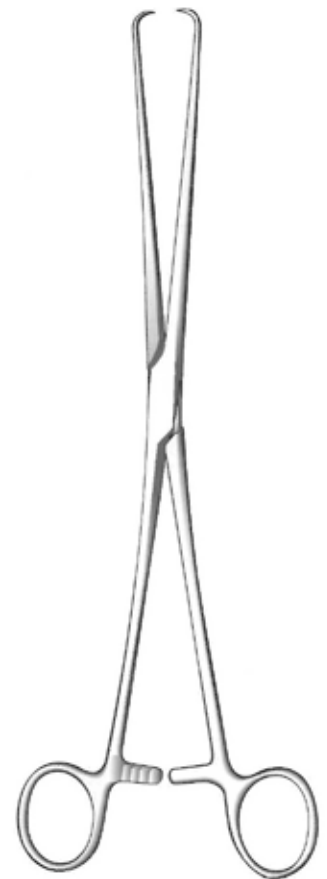

Braun
J-20-291
25 cm / 10"



Pozzi Palmer
J-20-980
23.5 cm / 9 1/4"



Pozzi Palmer
J-20-990
23.5 cm / 9 1/4"



Barrett
J-20-292
18 cm / 7"

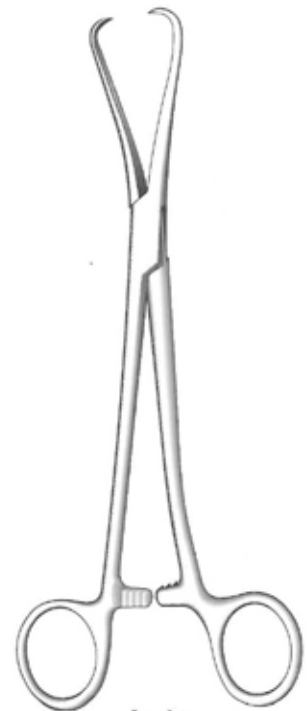

Jarcho
J-20-293
20 cm / 8"

Gynecology

Tenaculum Forceps, Amniotome

Hakenzangen, Amniotom

Pinzas Para Coger el Cuello Del Utero, Anmiotomo

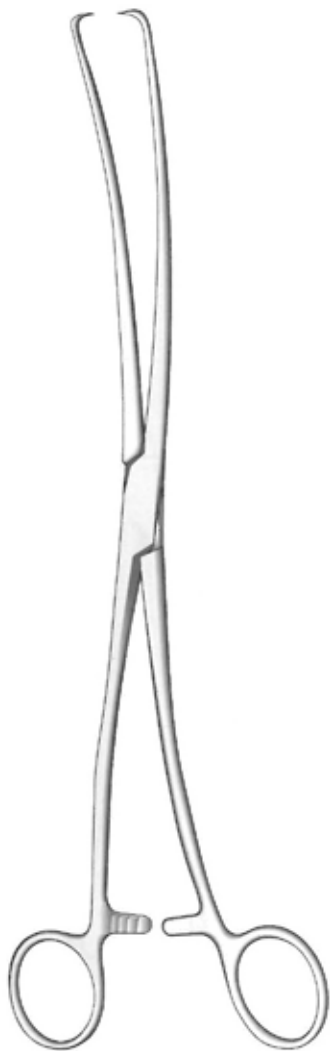

Duplay
J-20-295
28 cm / 11"



Beacham
J-20-296
26 cm / 10 1/4"
Amniotome for amnion bladder

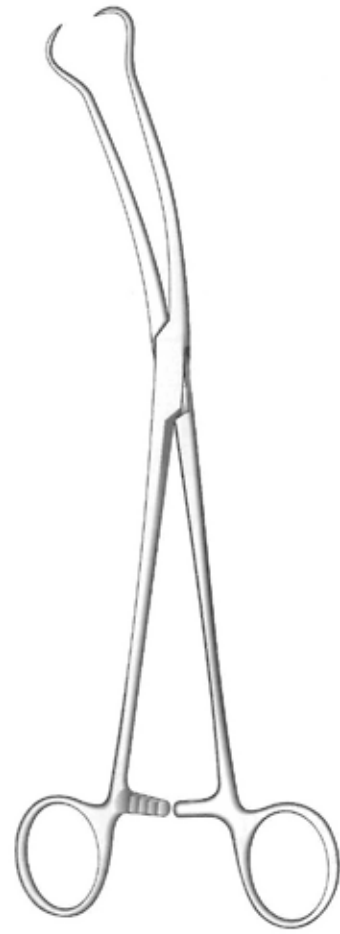

Skene
J-20-297
24 cm / 9 1/2"
Curved sideways

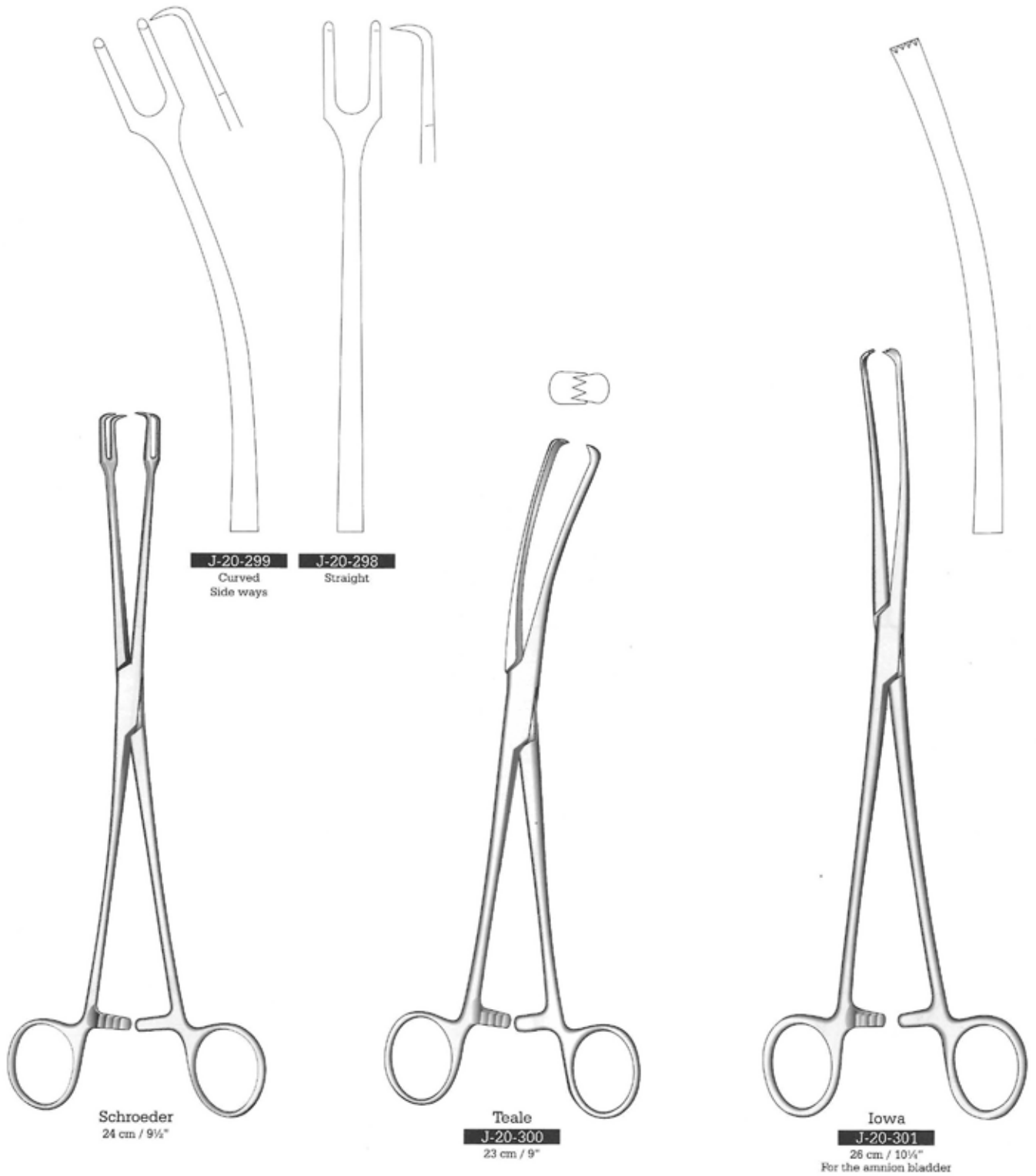

Gynecology

Tenaculum Forceps

Hakenzangen

Pinzas Para Coger el Cuello Del Utero

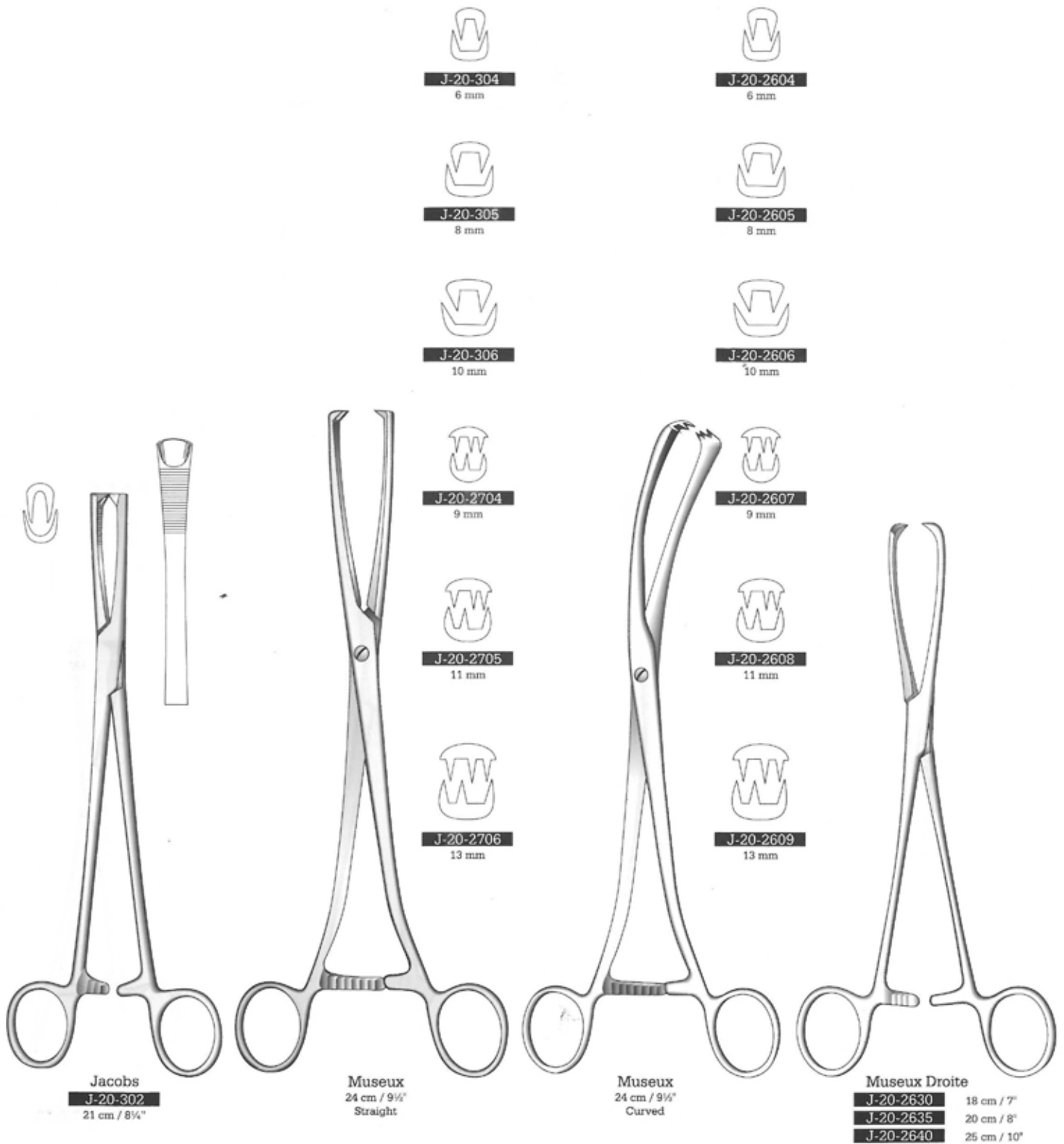

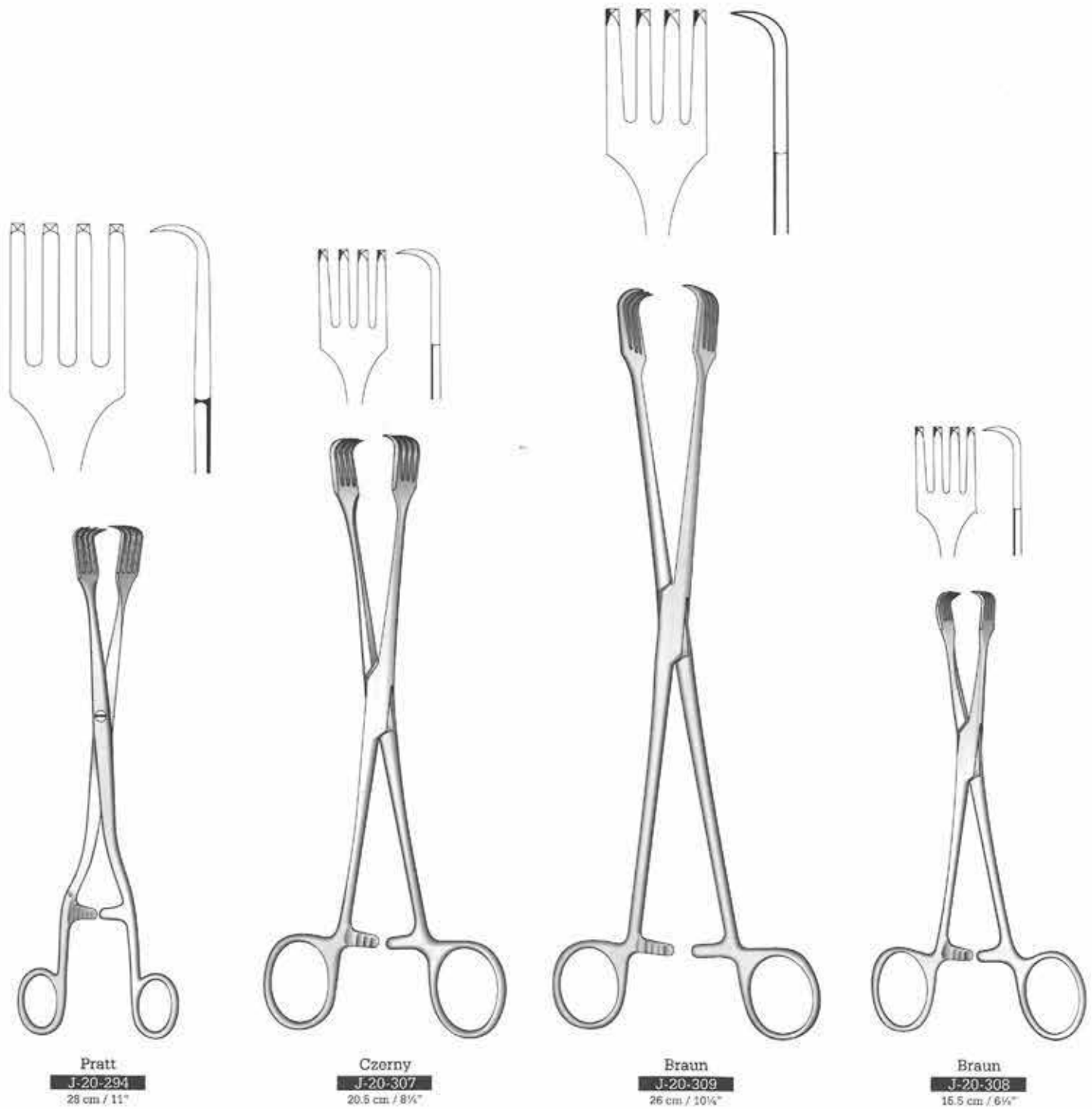

Gynecology

Uterine Polypus Forceps

Uterus Polypenzangen

PinzastParapolipos Uterine

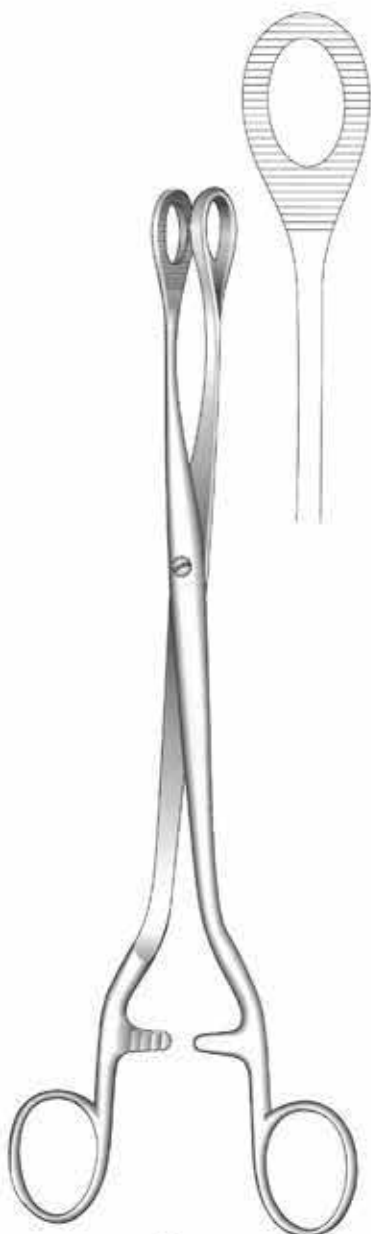

Noto
J-20-310
27 cm / 10 1/4"

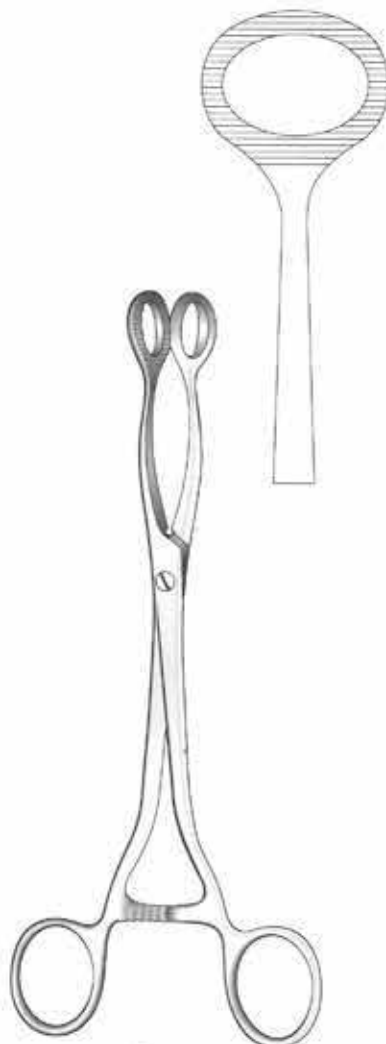

Doyen
J-20-311
20 cm / 8"

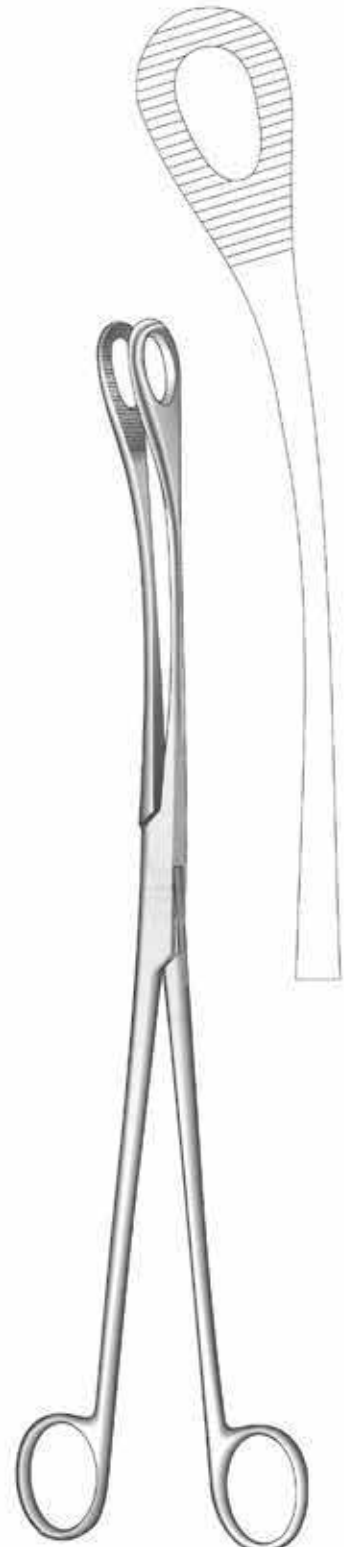

Kelly
J-20-312
32 cm / 12 1/4"

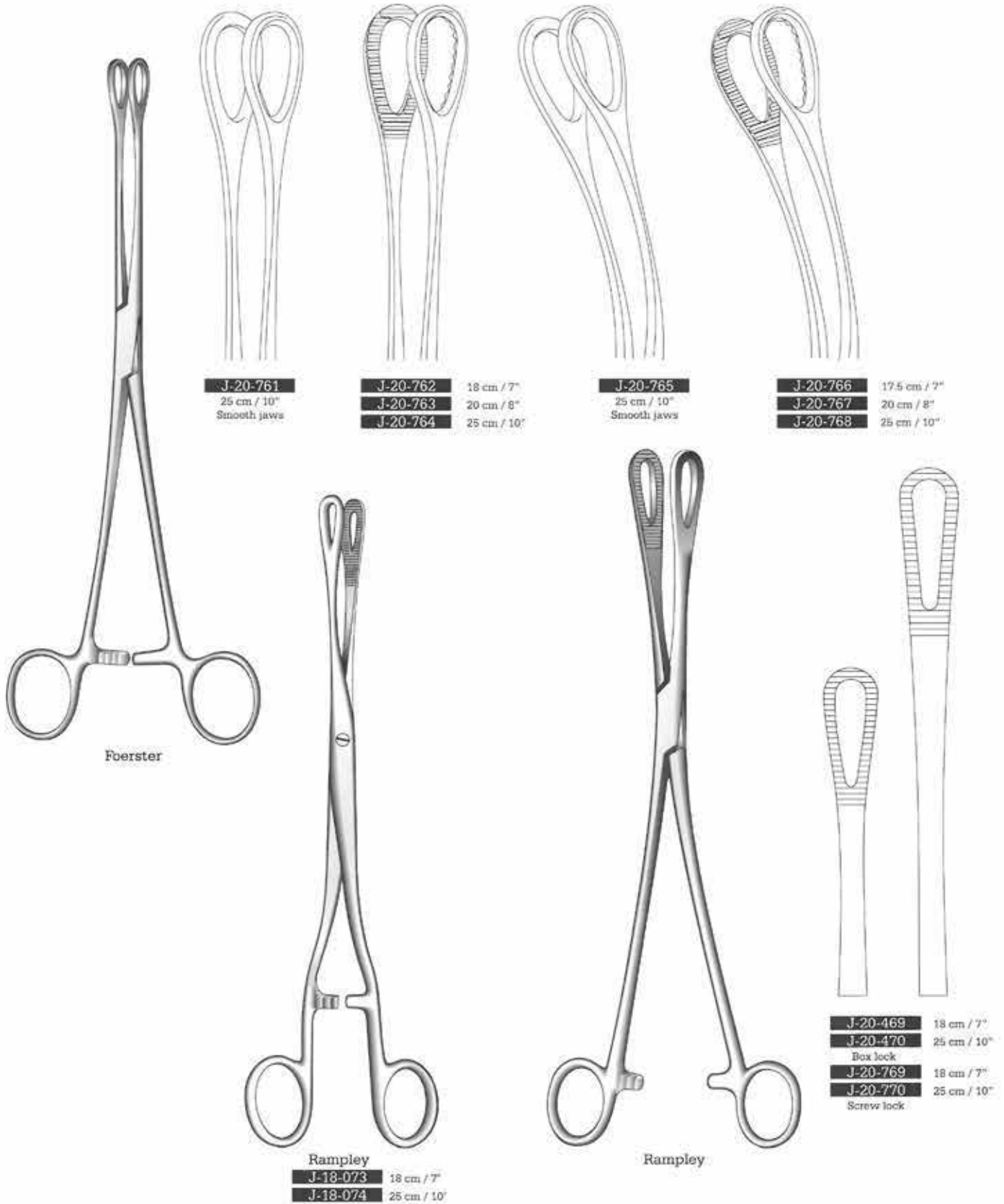

Gynecology

Hysterectomy & Vaginal Clamp Forceps

Hysterektomieklemmen, Vaginalklemmen

Pinzas-clamps para histerectomia Y vaginales

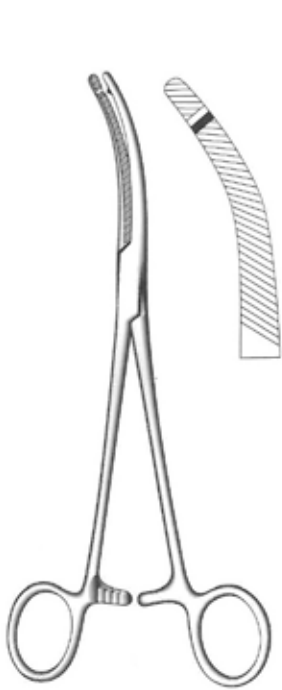

Heaney

- J-17-780** 19 cm / 7½"
- J-17-781** 21 cm / 8¼"
- J-17-782** 24.5 cm / 9¾"

Hysterectomy forceps
Heavy pattern, single tooth
Curved

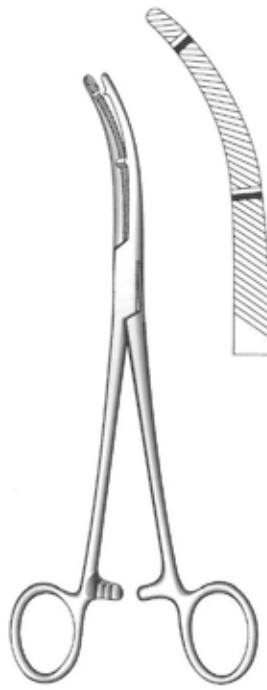

Heaney

- J-17-785** 19 cm / 7½"
- J-17-786** 21 cm / 8¼"

Heavy pattern
J-17-787 24.5 cm / 9¾"
Extra heavy pattern
Hysterectomy forceps
double tooth, curved

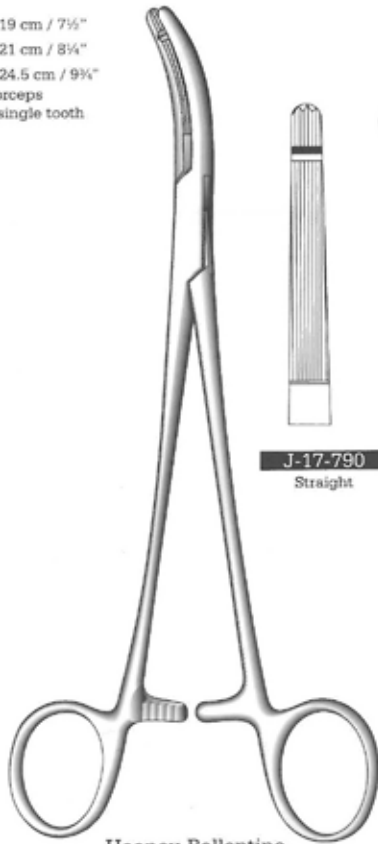

Heaney-Ballentine
21 cm / 8¼"

Longitudinal serrations, single tooth



J-17-790
Straight



J-17-791
Curved

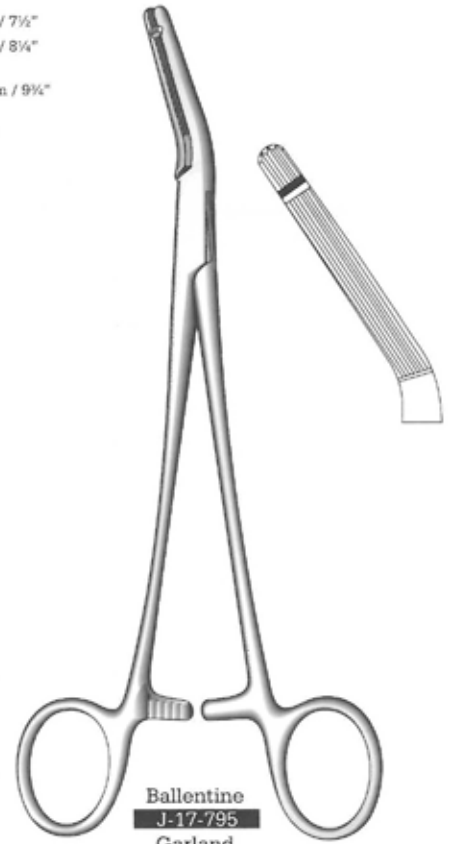

Ballentine

- J-17-795**
- Garland**
- J-17-796**

21 cm / 8¼"
Longitudinal serrations,
single tooth, angled on flat



Cheron
J-18-061
 25 cm / 10"

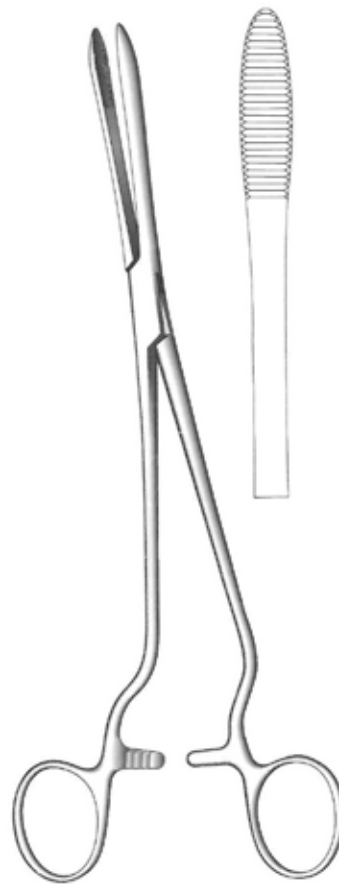

Cheron
J-18-063
 24 cm / 9½"
 Handles laterally angled

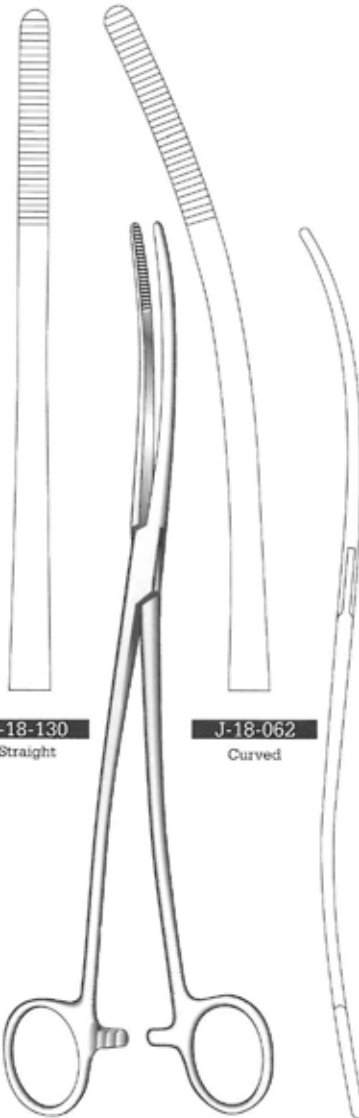

J-18-130
 Straight

J-18-062
 Curved

Bozemann
 26 cm / 10¼"

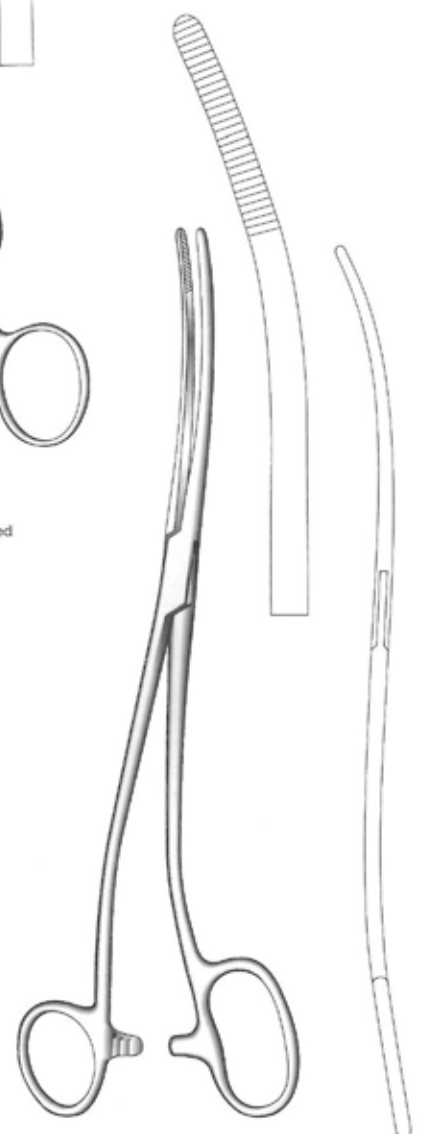

Bozemann-Douglas
J-18-064
 26 cm / 10¼"
 One ring large

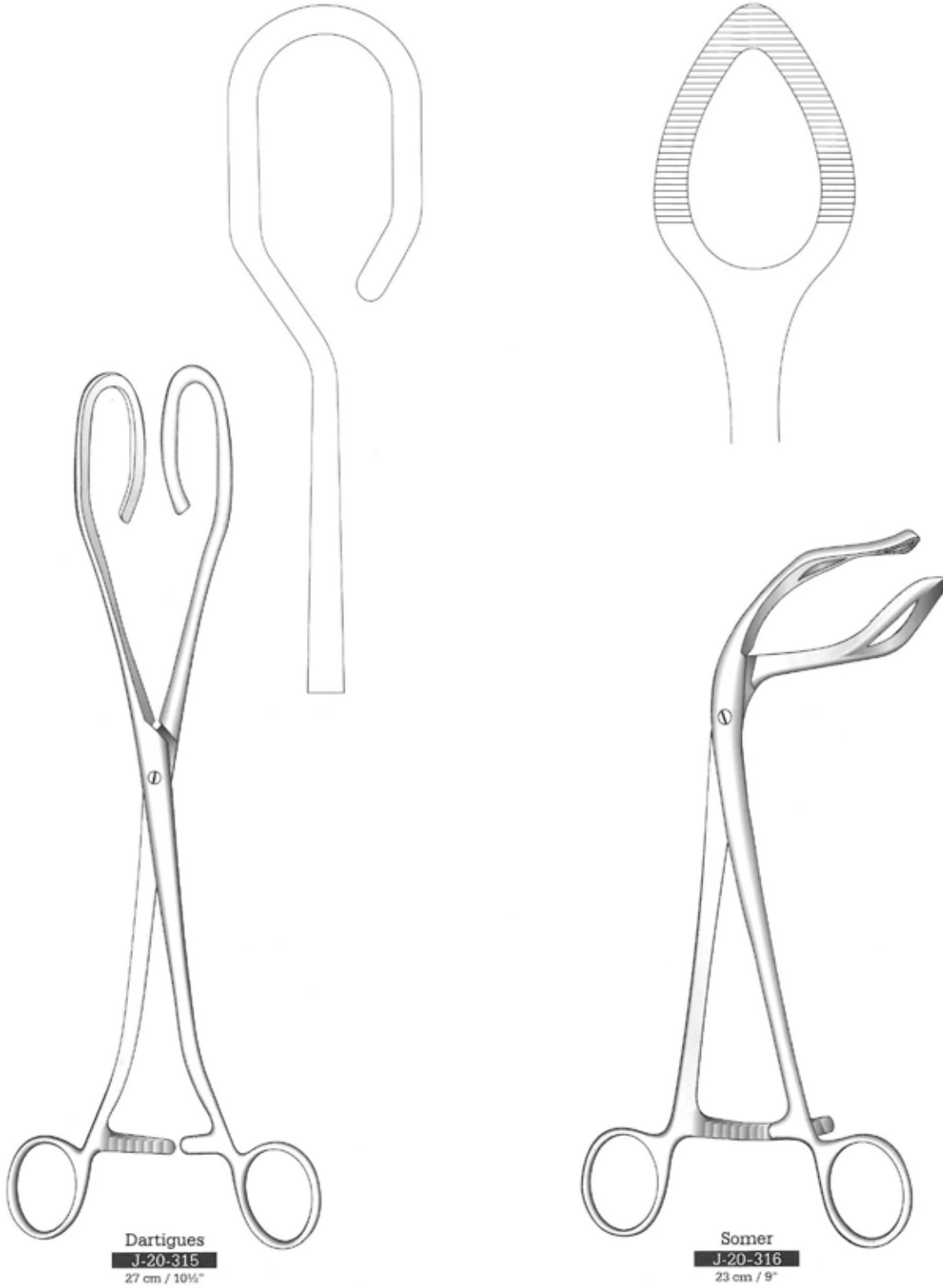

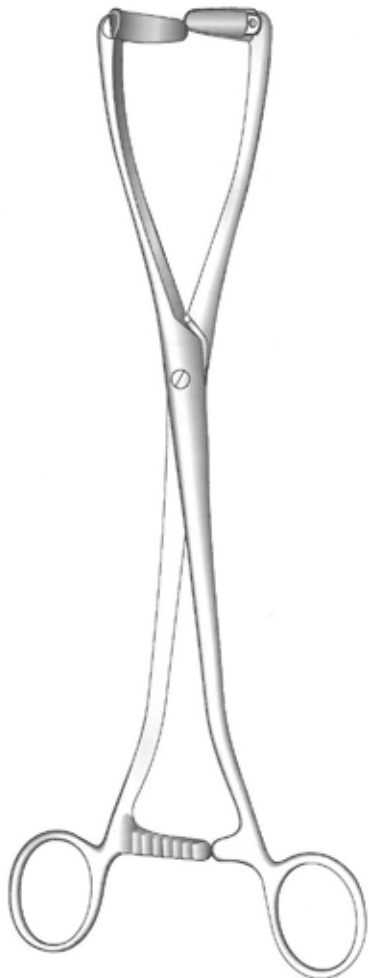
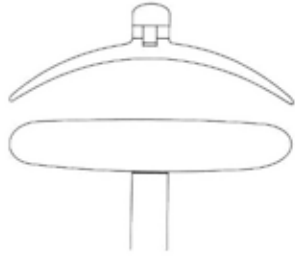

Collin
J-20-317
25 cm / 10"

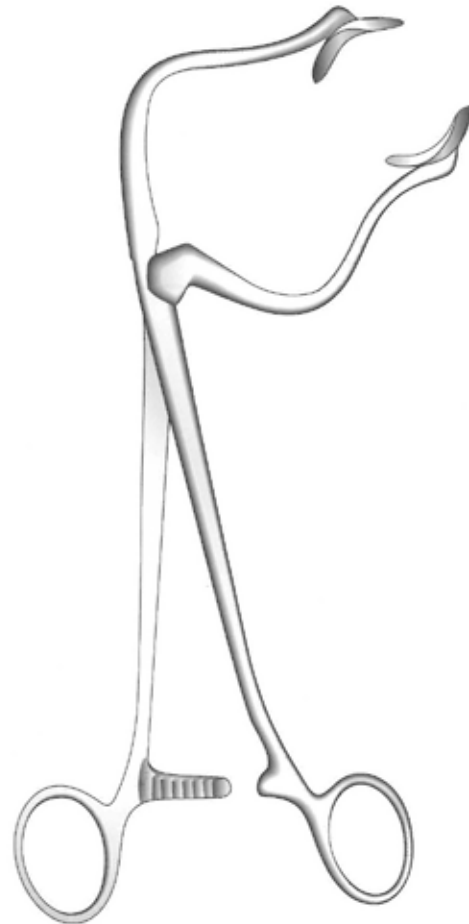

Shirodka Magendie
J-20-2740
26 cm / 10 1/4"

Gynecology

Uterine Sounds and Depressors

Uterussonden, Depressoren

Histeremetros, Depressores Uterinos



Sims
J-20-283
32 cm / 12½"
Malleable

J-20-284
32 cm / 12½"
Malleable

J-20-2750
Uterine probe

Valleix
J-20-285
25 cm / 10"

Braun
J-20-286
27.5 cm / 11"

Sims
J-20-287
26 cm / 10½"

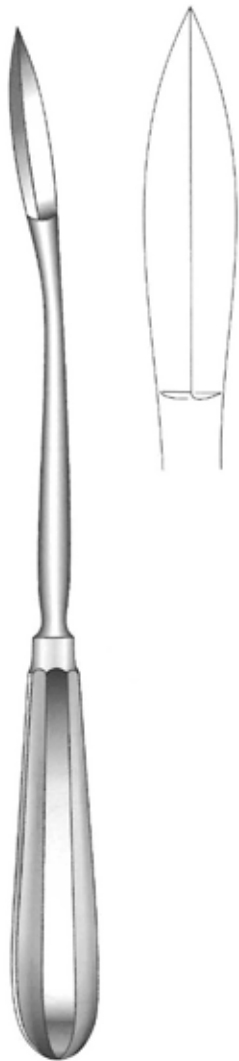

Segond
J-20-313
28 cm / 11"
Cutting edge 13 mm wide

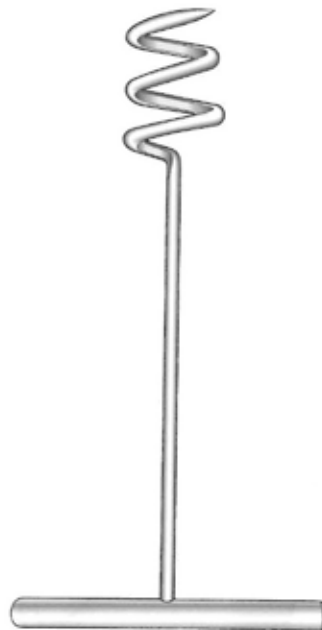

Doyen
J-20-314
14 cm / 5½"
Spiral

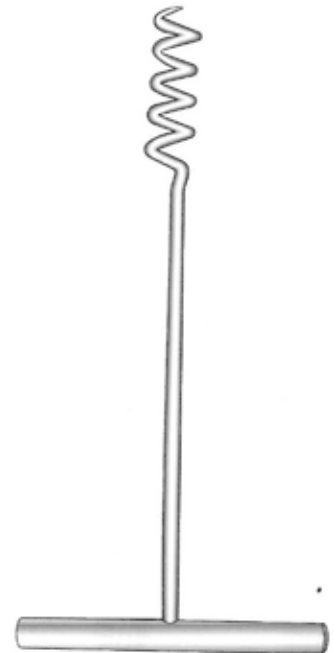

Doyen
J-20-444
17 cm / 6¾"
Spiral

Gynecology

Fistula Hooks, Cone Knives

Fistel Haken, Konusmesser

Gauchos P, Fistulas, Bisturip. Conos De Atraccion



Ayre
J-20-318

23 cm / 9"
Conization knife
Cutting edge 6.3 mm wide



Simon
J-20-319

22 cm / 8 1/4"



Simon
J-20-320

22 cm / 8 1/4"



Emmet
Uterine tenaculum hooks
23 cm / 9"
Sharp points



J-20-2760
Full-curved, small
Fig. 1



J-20-2765
Actual angle
Fig. 2



J-20-2770
Right angle
Fig. 3



J-20-2775
Half-curved, large
Fig. 4



J-20-2780
Double angle
Fig. 5

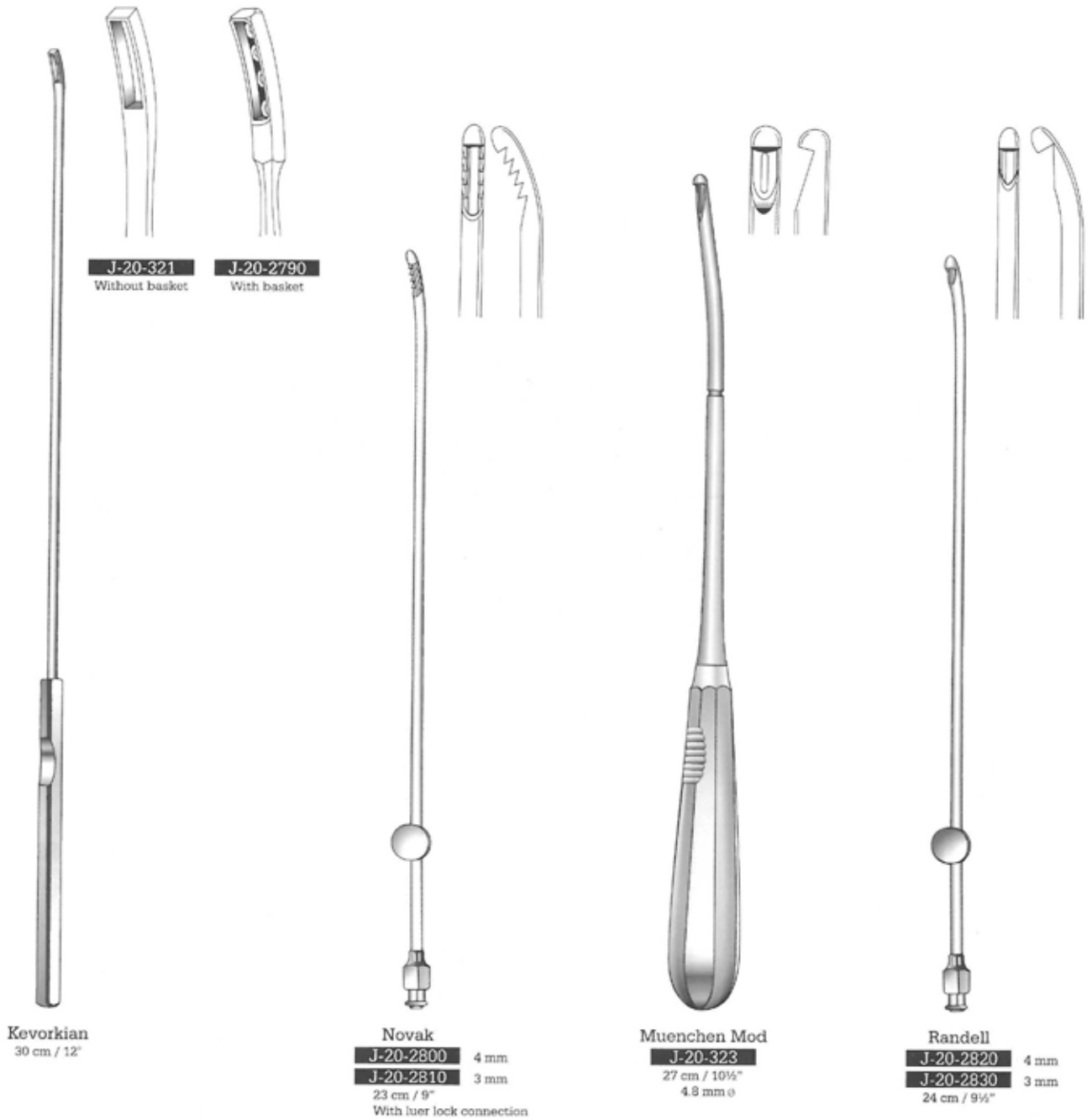

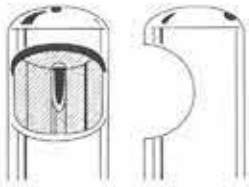
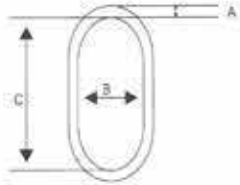

| | A | B | C |
|-----------|-------|------|--------|
| J-20-2860 | 5 mm | 1 mm | 4.0 mm |
| J-20-2865 | 6 mm | 1 mm | 5.0 mm |
| J-20-2870 | 7 mm | 1 mm | 5.5 mm |
| J-20-2875 | 8 mm | 1 mm | 6.0 mm |
| J-20-2880 | 9 mm | 1 mm | 6.5 mm |
| J-20-2885 | 10 mm | 2 mm | 7.5 mm |
| J-20-2890 | 12 mm | 2 mm | 10 mm |
| J-20-2895 | 14 mm | 2 mm | 11 mm |

Uterine suction tube



J-20-2850
 13 cm / 5"
 Uterine suction connector



Uterine suction tubes



J-20-371
 29 cm / 11 1/2"
 3 mm
 Specimen & aspirating
 curette



J-20-372
 29 cm / 11 1/2"
 4.5 mm
 Specimen & aspirating
 curette



Aspirating curettes
 29 cm / 11 1/2"



J-20-373
 6 mm



J-20-374
 8 mm



J-20-375
 10 mm

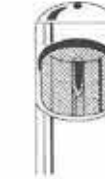

J-20-376
 12 mm

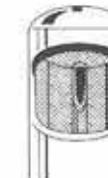

J-20-377
 14 mm



J-20-378
 12 cm / 4 3/4"
 Coupling piece



Rigid curettes
(Plain shaft)



Malleable curettes
(Grooved shaft)



Recamier-Sims-Bumm
Sharp blades

| Sharp blades | | | | Fig. | Size mm |
|--------------|-----------|-----------|-----------|------|---------|
| Rigid | | Malleable | | | |
| 26 cm | 31 cm | 26 cm | 31 cm | | |
| J-20-3005 | J-20-3105 | J-20-3205 | J-20-3305 | 00 | 5 |
| J-20-3006 | J-20-3106 | J-20-3206 | J-20-3306 | 0 | 6 |
| J-20-3007 | J-20-3107 | J-20-3207 | J-20-3307 | 1 | 7 |
| J-20-3008 | J-20-3108 | J-20-3208 | J-20-3308 | 2 | 8 |
| J-20-3009 | J-20-3109 | J-20-3209 | J-20-3309 | 3 | 9 |
| J-20-3011 | J-20-3111 | J-20-3211 | J-20-3311 | 4 | 11 |
| J-20-3012 | J-20-3112 | J-20-3212 | J-20-3312 | 5 | 12 |
| J-20-3014 | J-20-3114 | J-20-3214 | J-20-3314 | 6 | 14 |
| J-20-3015 | J-20-3115 | J-20-3215 | J-20-3315 | 7 | 15 |
| J-20-3016 | J-20-3116 | J-20-3216 | J-20-3316 | 8 | 16 |
| J-20-3019 | J-20-3119 | J-20-3219 | J-20-3319 | 9 | 19 |
| J-20-3020 | J-20-3120 | J-20-3220 | J-20-3320 | 10 | 20 |
| J-20-3021 | J-20-3121 | J-20-3221 | J-20-3321 | 11 | 21 |
| J-20-3023 | J-20-3123 | J-20-3223 | J-20-3323 | 12 | 23 |
| 34 cm | | 34 cm | | | |
| J-20-3125 | | J-20-3325 | | 13 | 25 |
| J-20-3130 | | J-20-3330 | | 14 | 30 |
| J-20-3135 | | J-20-3335 | | 15 | 35 |
| J-20-3140 | | J-20-3340 | | 16 | 40 |

| Blunt blades | | | | Fig. | Size mm |
|--------------|-----------|-----------|-----------|------|---------|
| Rigid | | Malleable | | | |
| 26 cm | 31 cm | 26 cm | 31 cm | | |
| J-20-3505 | J-20-3605 | J-20-3705 | J-20-3805 | 00 | 5 |
| J-20-3506 | J-20-3606 | J-20-3706 | J-20-3806 | 0 | 6 |
| J-20-3507 | J-20-3607 | J-20-3707 | J-20-3807 | 1 | 7 |
| J-20-3508 | J-20-3608 | J-20-3708 | J-20-3808 | 2 | 8 |
| J-20-3509 | J-20-3609 | J-20-3709 | J-20-3809 | 3 | 9 |
| J-20-3511 | J-20-3611 | J-20-3711 | J-20-3811 | 4 | 11 |
| J-20-3512 | J-20-3612 | J-20-3712 | J-20-3812 | 5 | 12 |
| J-20-3514 | J-20-3614 | J-20-3714 | J-20-3814 | 6 | 14 |
| J-20-3515 | J-20-3615 | J-20-3715 | J-20-3815 | 7 | 15 |
| J-20-3516 | J-20-3616 | J-20-3716 | J-20-3816 | 8 | 16 |
| J-20-3519 | J-20-3619 | J-20-3719 | J-20-3819 | 9 | 19 |
| J-20-3520 | J-20-3620 | J-20-3720 | J-20-3820 | 10 | 20 |
| J-20-3521 | J-20-3621 | J-20-3721 | J-20-3821 | 11 | 21 |
| J-20-3523 | J-20-3623 | J-20-3723 | J-20-3823 | 12 | 23 |
| 34 cm | | 34 cm | | | |
| J-20-3625 | | J-20-3825 | | 13 | 25 |
| J-20-3630 | | J-20-3830 | | 14 | 30 |
| J-20-3635 | | J-20-3835 | | 15 | 35 |
| J-20-3640 | | J-20-3840 | | 16 | 40 |

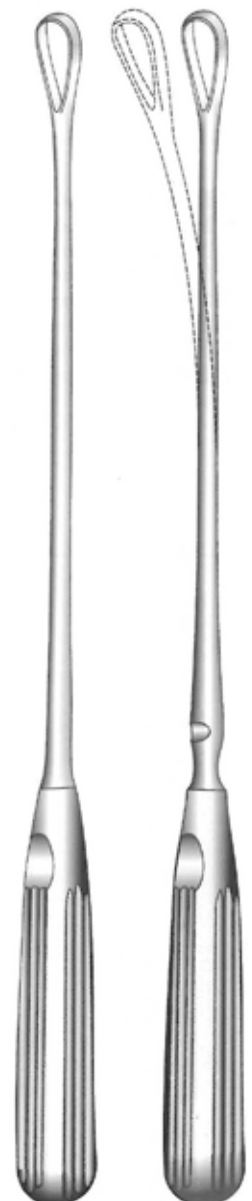

Recamier-Sims-Bumm
Blunt blades

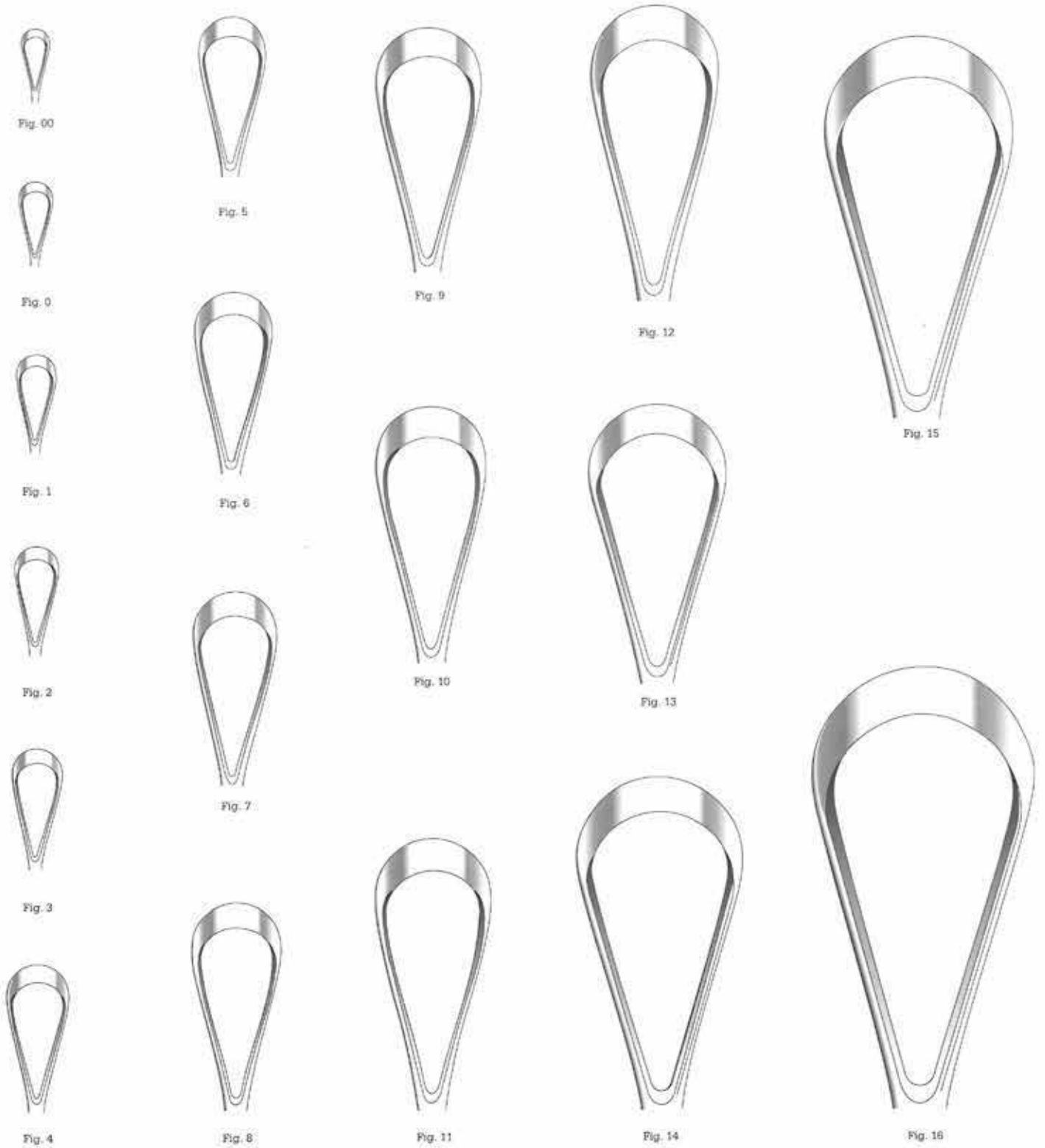

Not illustrated

Mayo Blake
 J-20-4500
 Curette, double ended

Sims
 28 cm / 11"
 Sharp, malleable

J.O.M.W Type
 28 cm / 11"
 Uterine curettes



J-20-246
 15 mm



J-20-244
 12 mm



J-20-242
 10 mm



J-20-240
 7 mm



J-20-238
 4 mm



J-20-775
 15 mm



J-20-774
 12 mm



J-20-353
 9 mm



J-20-352
 7.5 mm







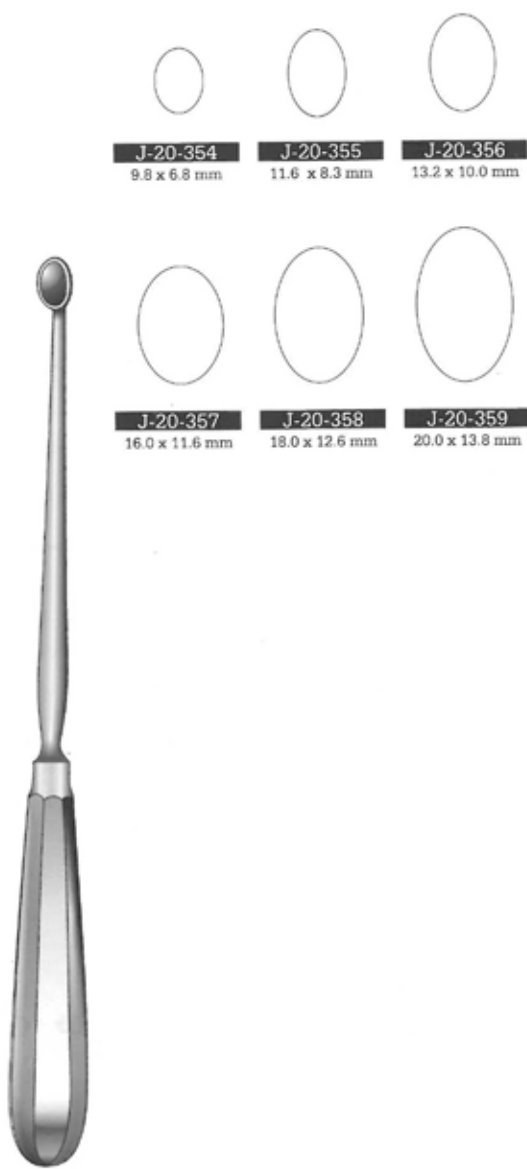

J-20-351
 6 mm



J-20-350
 4.5 mm





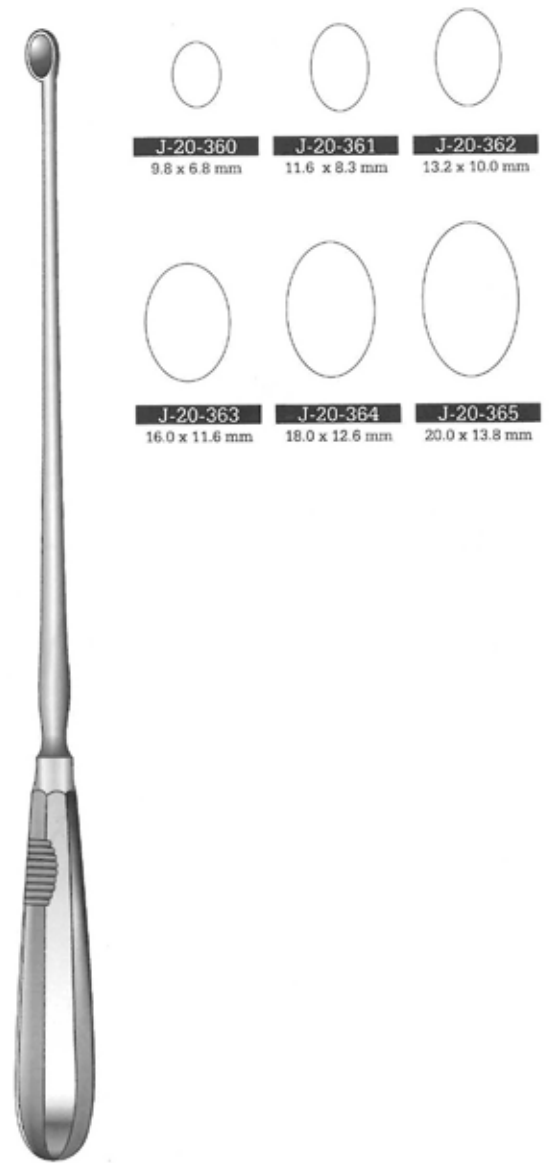

Schroeder
 30 cm / 12"
 Sharp, rigid

| | | |
|--|--|--|
|  |  |  |
| J-20-354 9.8 x 6.8 mm | J-20-355 11.6 x 8.3 mm | J-20-356 13.2 x 10.0 mm |
|  |  |  |
| J-20-357 16.0 x 11.6 mm | J-20-358 18.0 x 12.6 mm | J-20-359 20.0 x 13.8 mm |

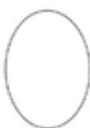
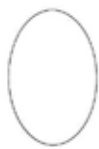

Simon
 25 cm / 10"
 Sharp, rigid

| | | |
|--|--|--|
|  |  |  |
| J-20-360 9.8 x 6.8 mm | J-20-361 11.6 x 8.3 mm | J-20-362 13.2 x 10.0 mm |
|  |  |  |
| J-20-363 16.0 x 11.6 mm | J-20-364 18.0 x 12.6 mm | J-20-365 20.0 x 13.8 mm |

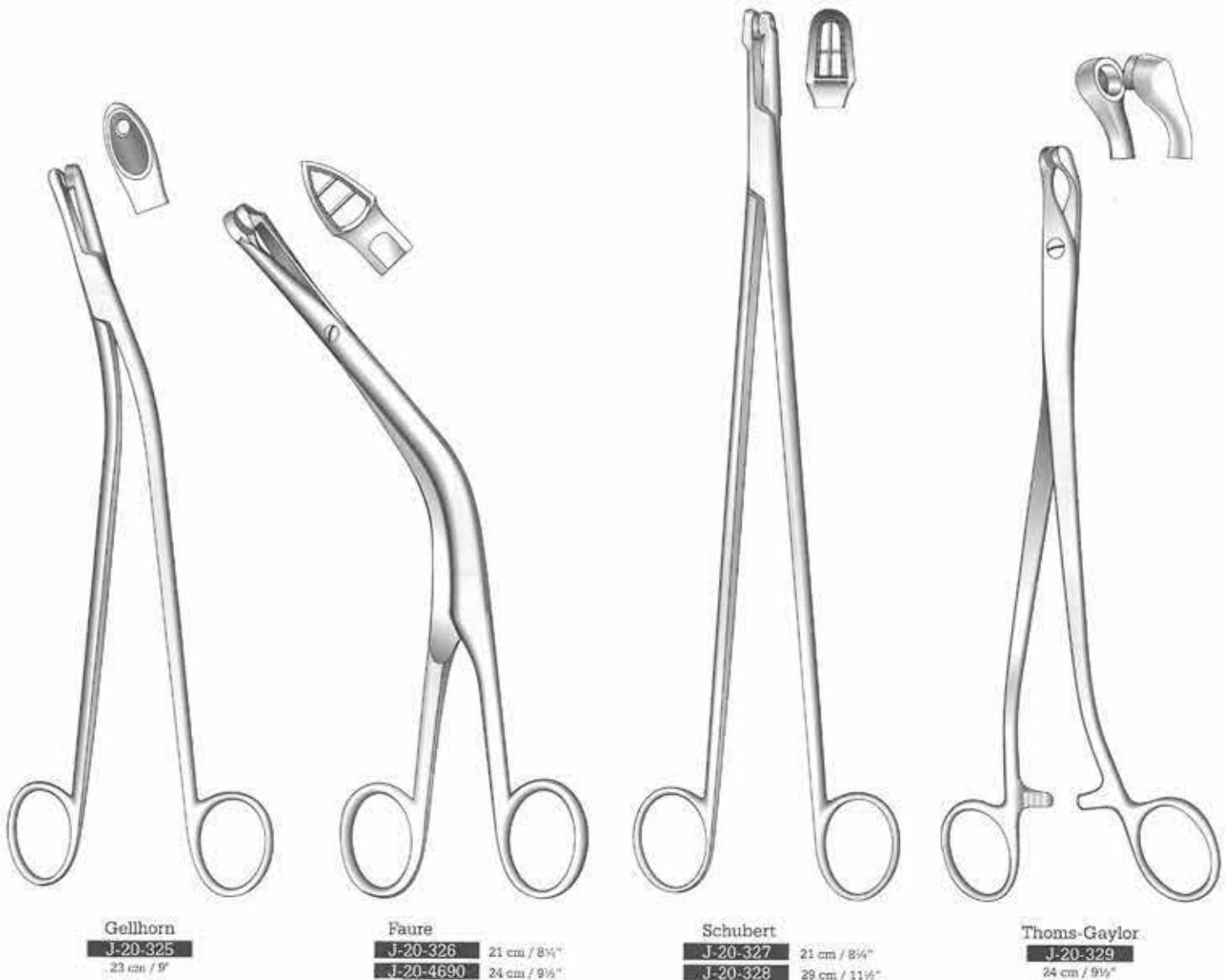

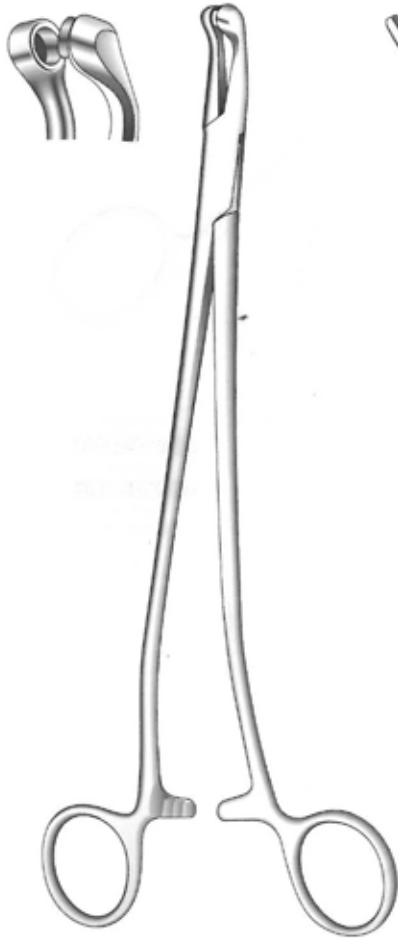

Thoms-Gaylor
J-20-330 22 cm / 8½"
J-20-331 24 cm / 9½"

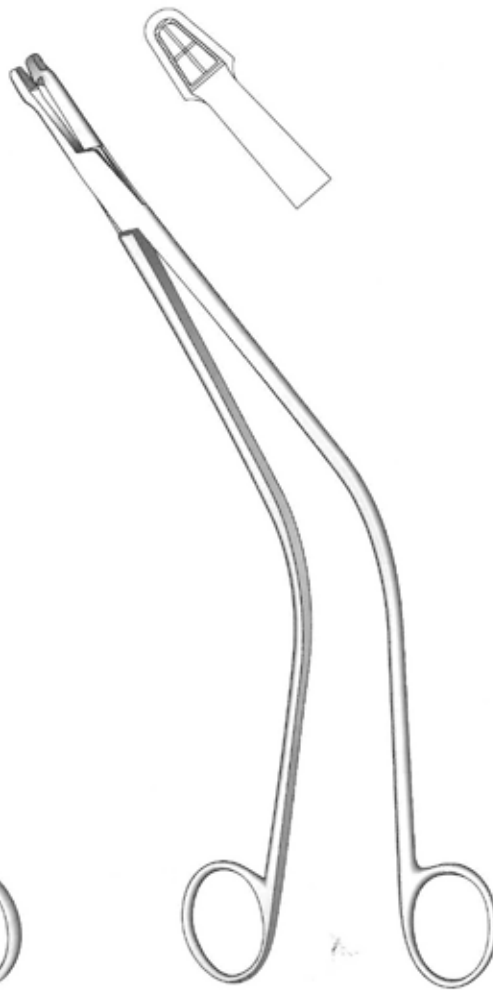

Schubert
J-20-332
26 cm / 10¼"

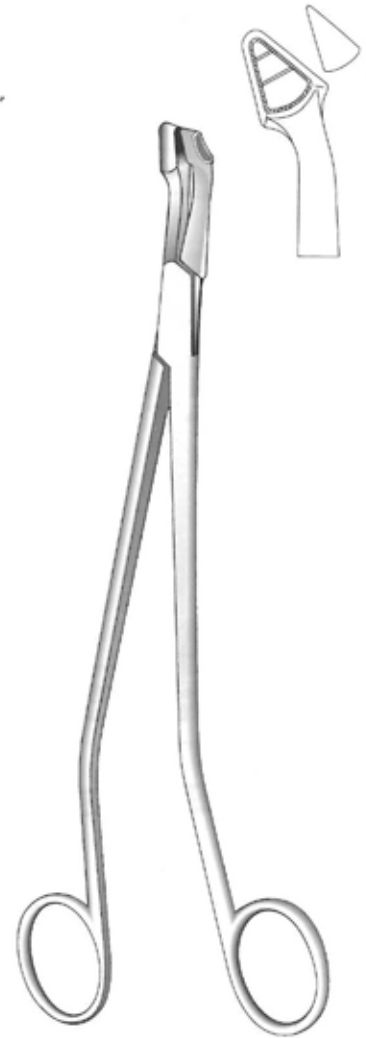

Van-Doren
J-20-333
24 cm / 9½"

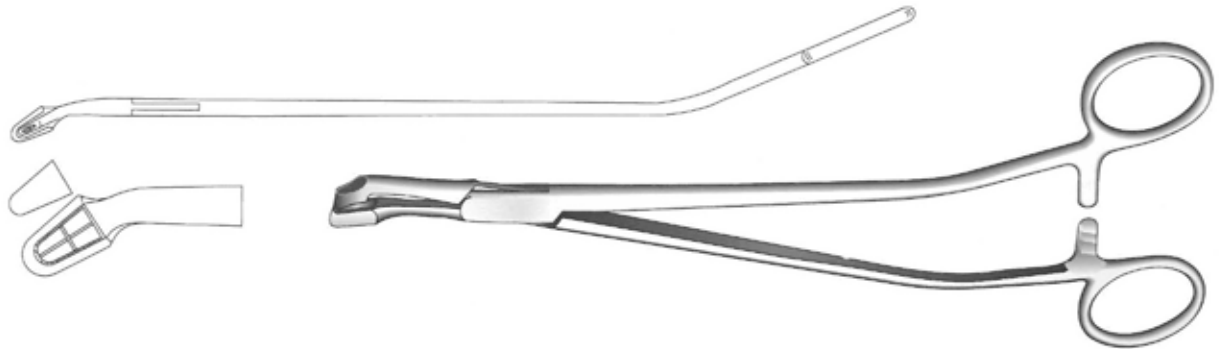

Van-Doren
J-20-334
 25 cm / 10"

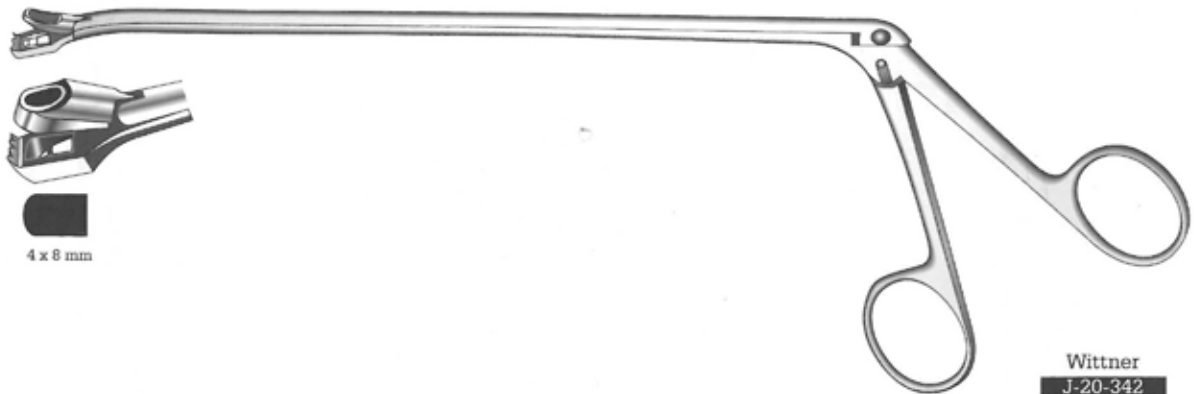

Wittner
J-20-342
 Straight
J-20-341
 Curved
 23 cm / 9"

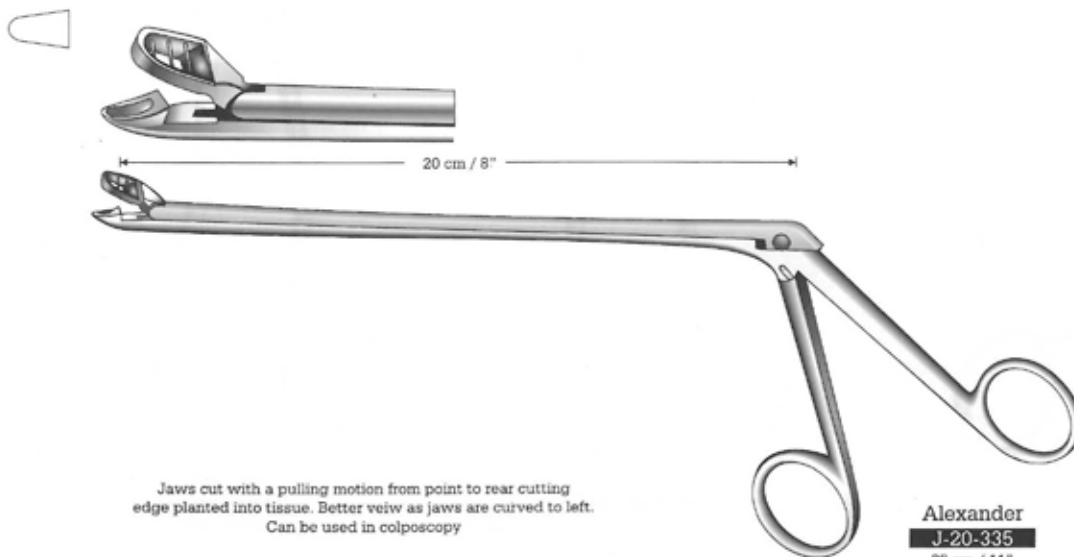

Jaws cut with a pulling motion from point to rear cutting edge planted into tissue. Better view as jaws are curved to left.
 Can be used in colposcopy

Alexander
J-20-335
 28 cm / 11"

Gynecology

Cervical Biopsy and Specimen Forceps

Probeexzisionszangen

Pinzas Sacca-Bocados Para Biopsia

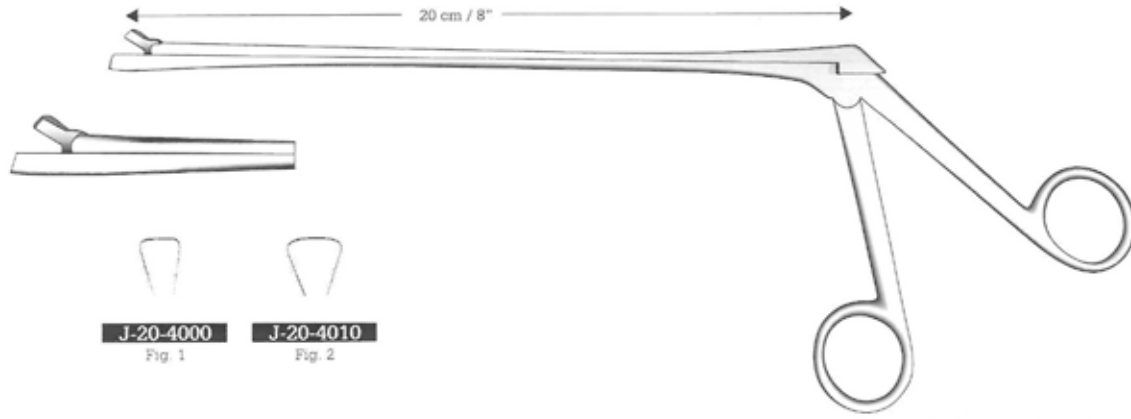

Debarker Biopsy

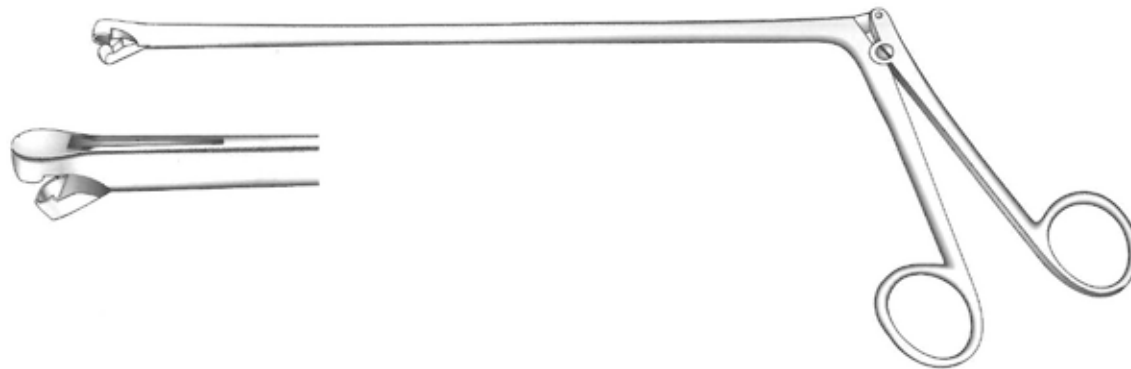

Berger

J-20-4020
21 cm / 8 1/4"

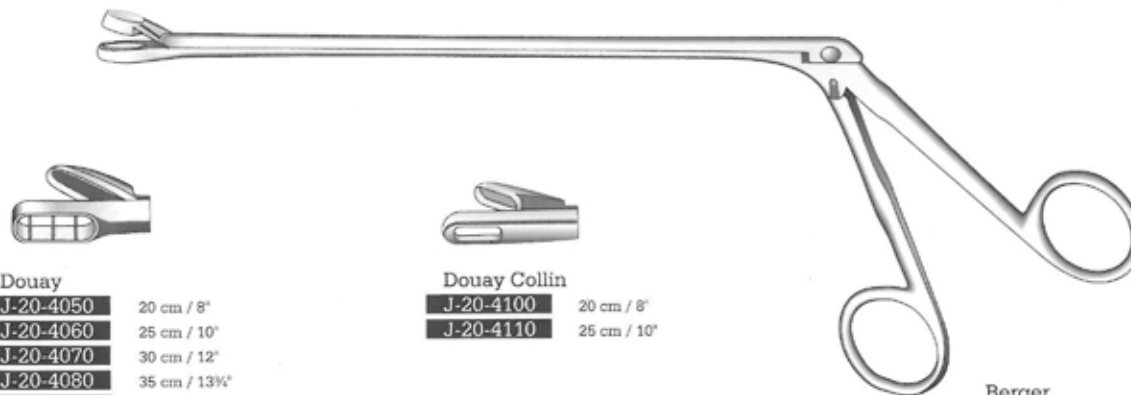

Douay

J-20-4050 20 cm / 8"
J-20-4060 25 cm / 10"
J-20-4070 30 cm / 12"
J-20-4080 35 cm / 13 3/4"
J-20-4090 40 cm / 15 1/2"

Douay Collin

J-20-4100 20 cm / 8"
J-20-4110 25 cm / 10"

Berger

J-20-4055
22 cm / 8 1/2"

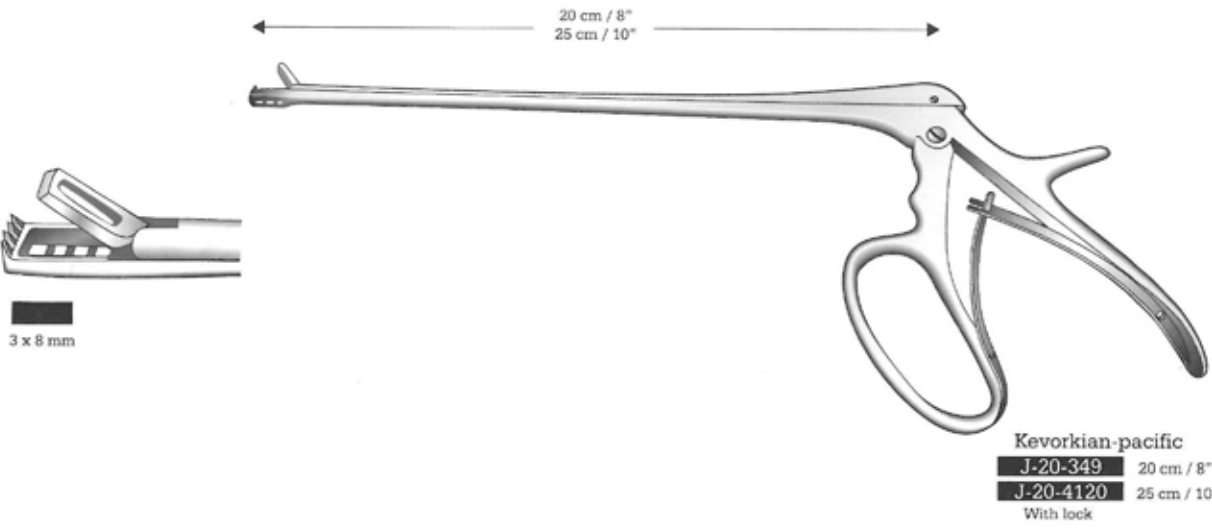
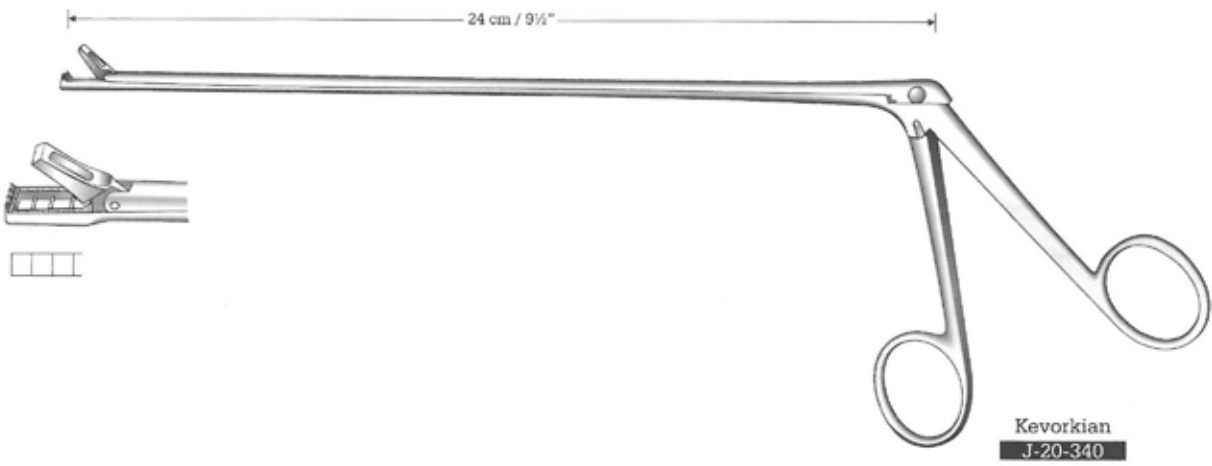
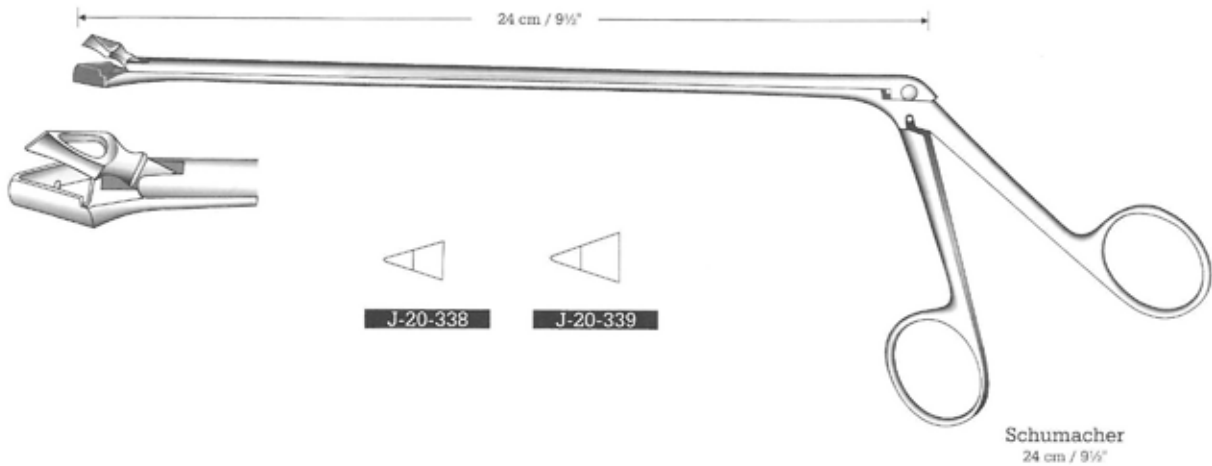

Gynecology

Cervical Biopsy and Specimen Forceps

Probeexzisionszangen

Pinzas Sacabocados Para Biopsia

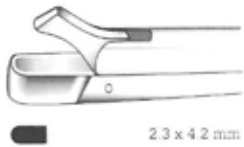

2.3 x 4.2 mm

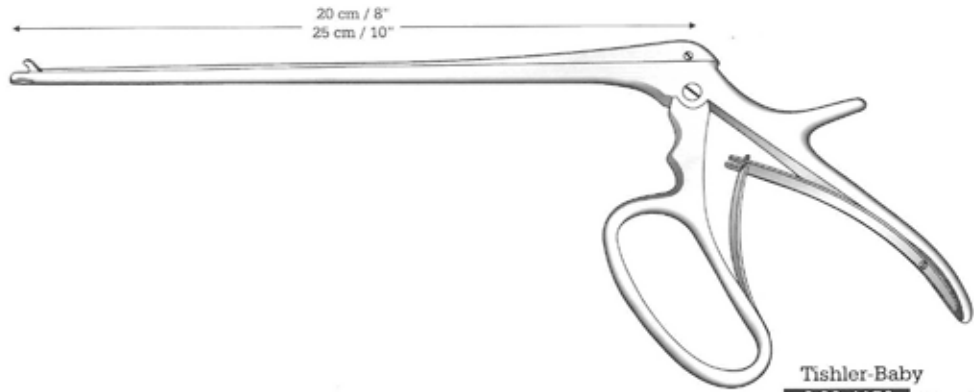

Tishler-Baby

J-20-4150 20 cm / 8"

J-20-4160 25 cm / 10"

With lock

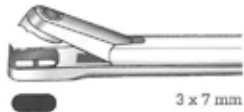

3 x 7 mm

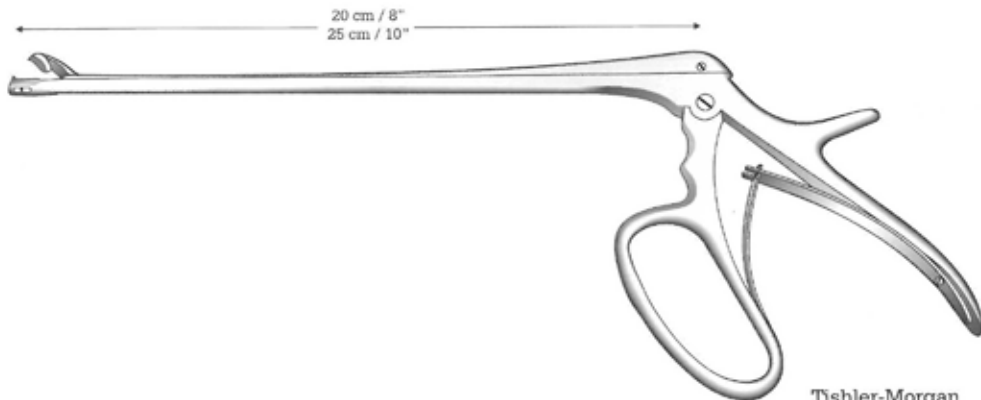

Tishler-Morgan

J-20-343 20 cm / 8"

J-20-4170 25 cm / 10"

With lock

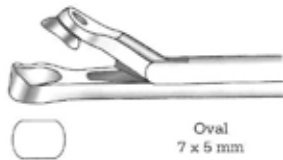

Oval
7 x 5 mm

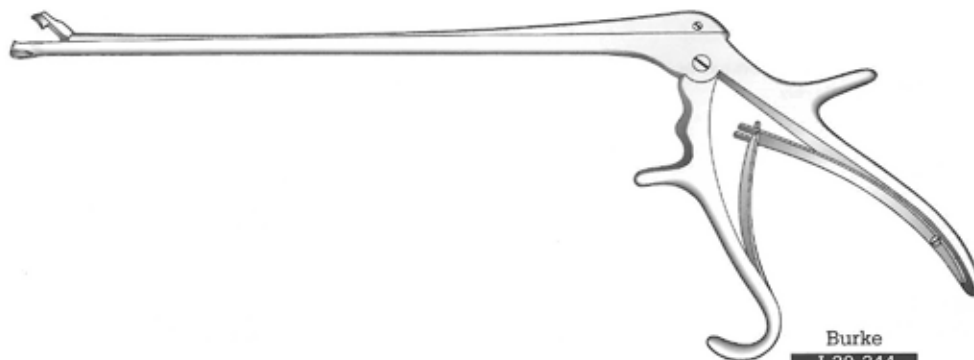

Burke

J-20-344

With lock



Seiffert
J-20-201
 with handle



Schumacher
J-20-205
 With drawing cut
 with handle



Tischler
J-20-207
 with handle



Kevorkian
J-20-4180
 with handle



Krause
J-20-209 **J-20-211**
 with handle



J-20-213
 with handle



J-20-216
 with handle

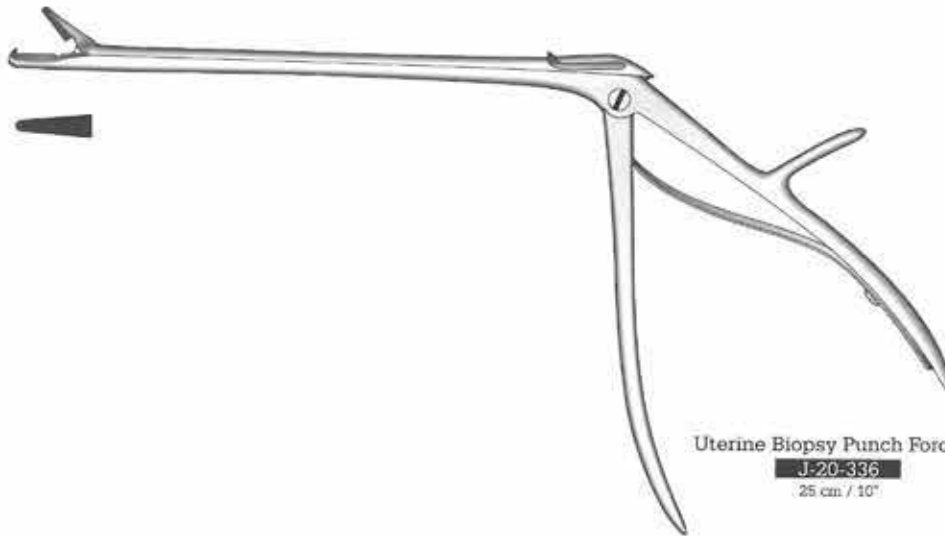

Uterine Biopsy Punch Forceps
J-20-336
 25 cm / 10"



Huber
J-34-690
 Universal handle



Tischler-Morgan
J-20-345 Complete with handle
J-20-4210 Tip only
 Fig. 1

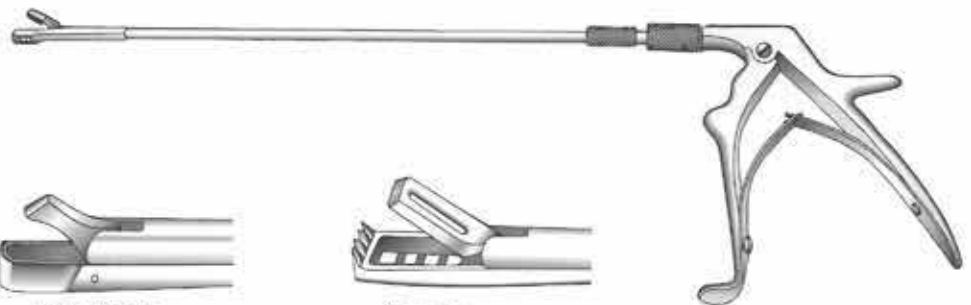

Townsend
J-20-4200 Handle only
J-20-4201 Handle with four tips



Oval
 3.7 x 5 mm
 Eppendorfer
J-20-346 Complete with handle
J-20-4220 Tip only
 Fig. 3



Baby Tischler
J-20-347 Complete with handle
J-20-4230 Tip only
 Fig. 4



Kevorkian
J-20-348 Complete with handle
J-20-4240 Tip only
 mini
 Fig. 5



Collyer

J-20-4260

30 cm / 12"



J-20-384

34 cm / 13 1/4"

Graduated in centimeters.

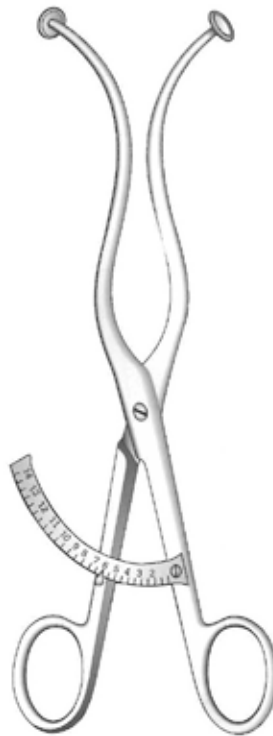

Delee

J-20-382

For interior measurements
between symphysis and
promontory

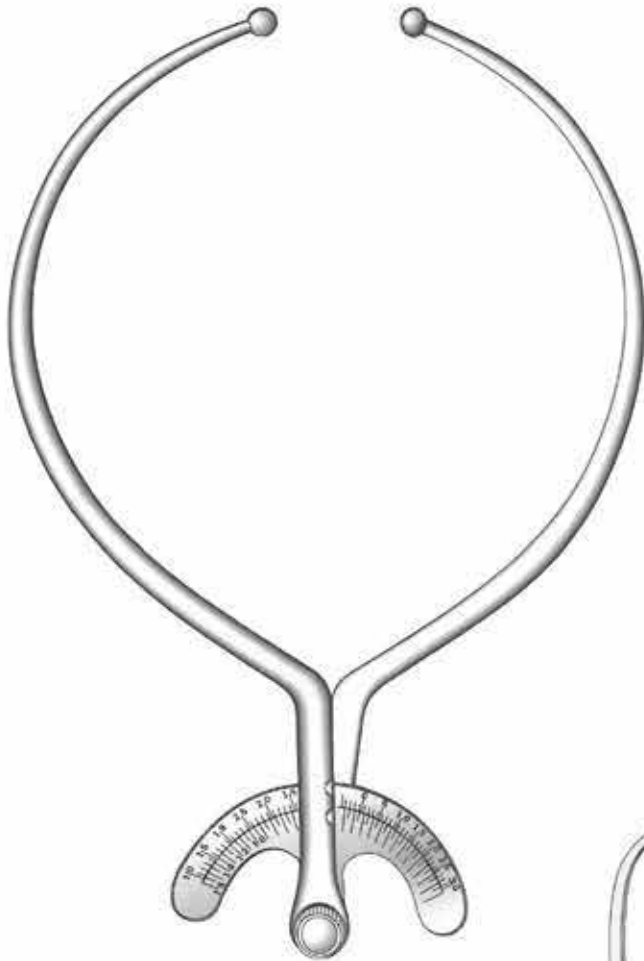

Broisky
J-20-380
 33 cm / 13"
 Graduated in centimeters.

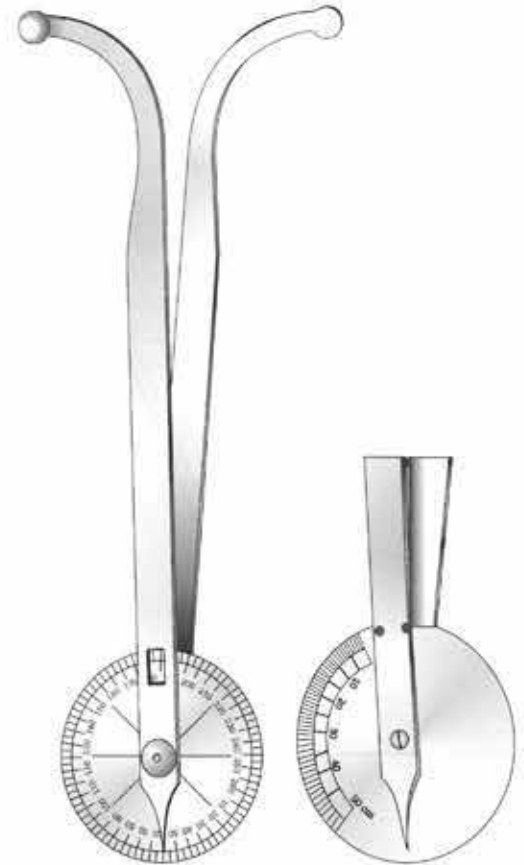

Thole
J-12-018
 34 cm / 13 1/4"
 Goniometer, graduated in centimeters.
 For internal & external measurements.



Collin
J-20-383
 35 cm / 13 3/4"
 Graduated in centimeters.



Kielland
J-20-394
42 cm / 16 3/4"



Nagele
J-20-395
40 cm / 16"

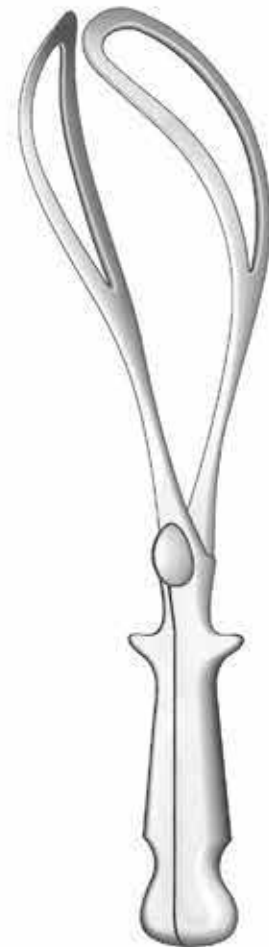

Nagele
J-20-393
35.5 cm / 14"

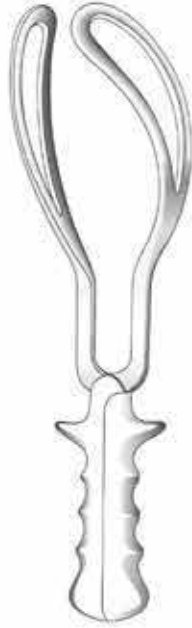

Simpson-Braun
J-20-390
 30.5 cm / 12"
J-20-4270
 35 cm / 14"



Simpson-Braun
J-20-391
 35 cm / 14"
J-20-4280
 30.5 cm / 12"



Piper
J-20-392
 44.5 cm / 17 1/2"
 For delivery of the after
 coming head in breech
 presentation

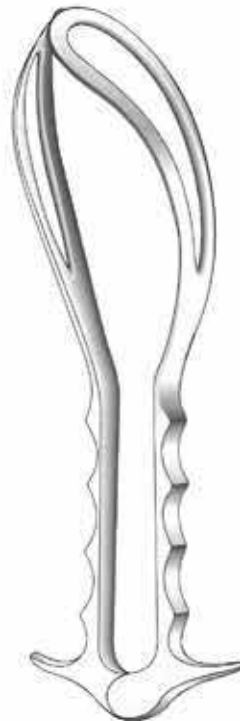

Boerma
J-20-387
 28 cm / 11"
 For caesarean section



Simpson
J-20-388
 23.5 cm / 9 1/4"
 For caesarean section



Wrigley
J-20-4290
25 cm / 10"
For caesarean section

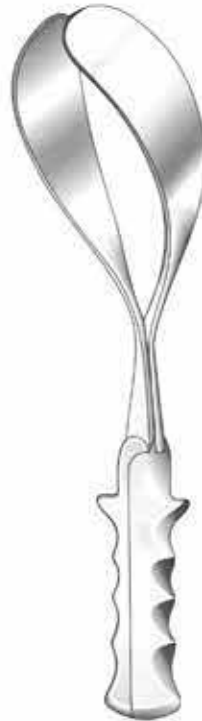

Mclean
J-20-445
39.5 cm / 15½"
Solid blades, short shanks

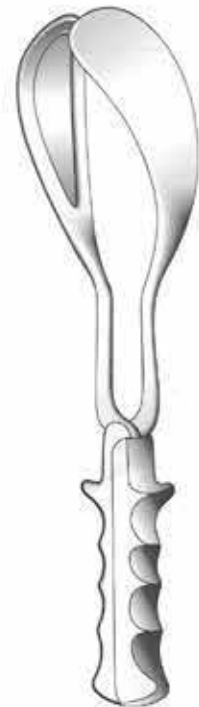

Simpsons-Luikart
J-20-446
38 cm / 15"
Solid blades



Luikart
J-20-447
39.5 cm / 15½"
Solid blades

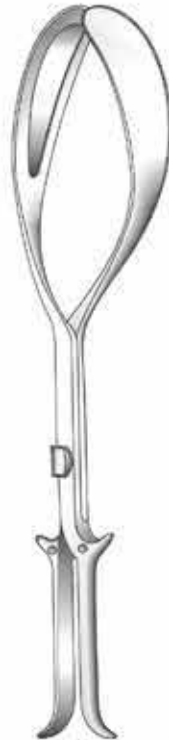

Kielland-Luikart
J-20-448
39.5 cm / 15½"
Solid blades



Kielland
J-20-449
39.5 cm / 15½"

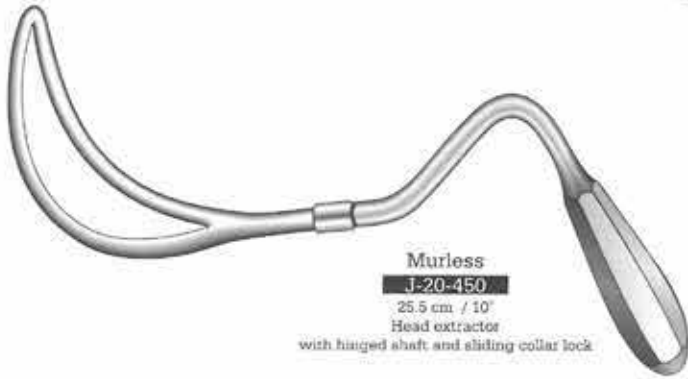

Murless
J-20-450
 25.5 cm / 10"
 Head extractor
 with hinged shaft and sliding collar lock



Dewey
J-20-456
 35.5 cm / 14"
 Obstetrical forceps
 with axis traction



Bailey-Williamson
J-20-451
 39.5 cm / 15½"



Hawks-Dennen
J-20-452
 38 cm / 15"



Barton
J-20-453
 35.5 cm / 14"
 One hinged blade



Mclean-Luikart
J-20-454
 40 cm / 15¾"
 Solid blades, long shanks



Mclean-Tucker-Luikart
J-20-455
 40 cm / 15¾"
 Solid blades, long shanks

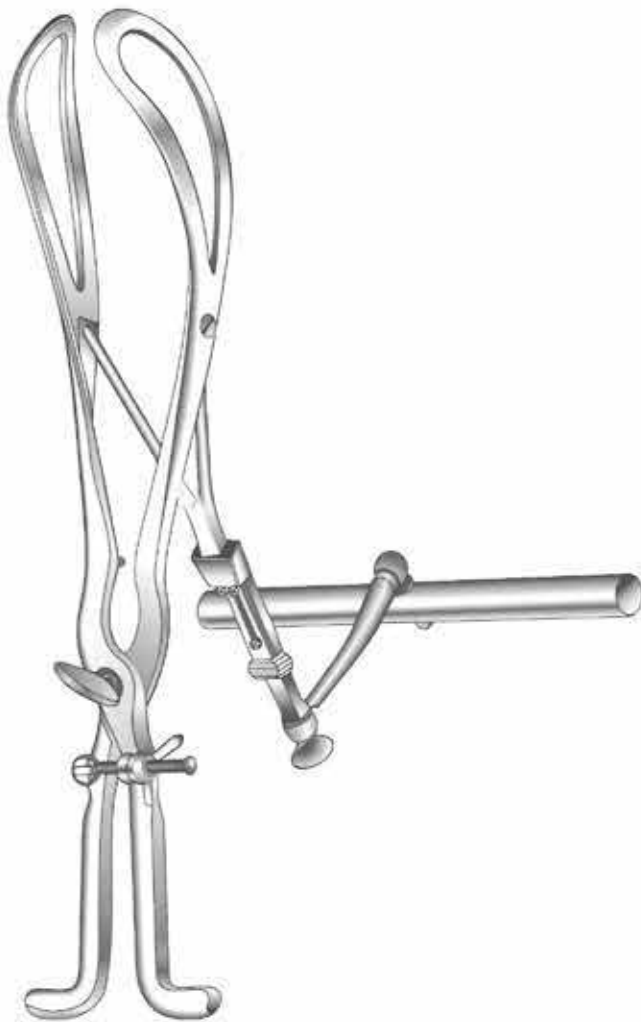

Tarnier
J-20-385
40 cm / 16"
With traction rod



Barnes-Neville
J-20-4300
43.5 cm / 17"
With traction handle

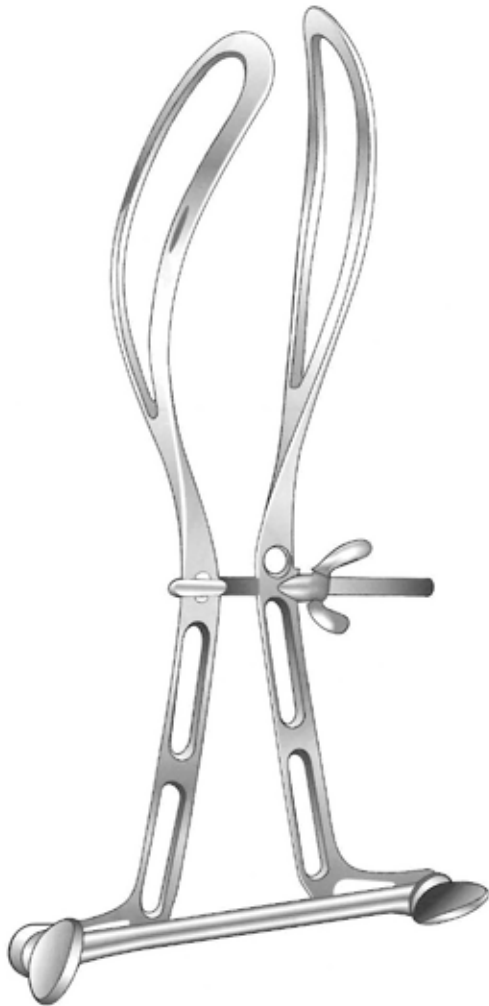

Barton
J-20-4310
36 cm / 14 $\frac{1}{4}$ "

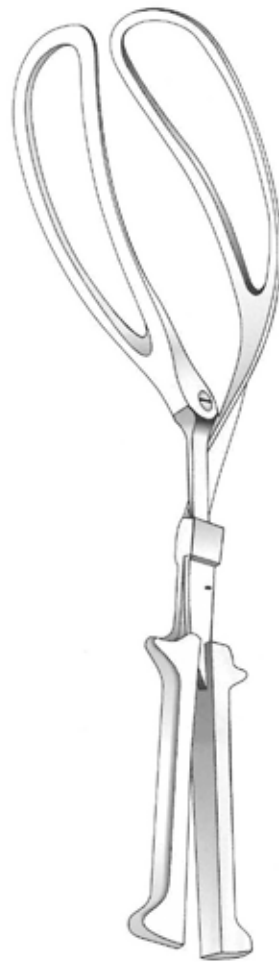

Demelin Suzor
J-20-4320
32 cm / 12 $\frac{1}{2}$ "

Gynecology

Obstetrics-Perforator, Cranioclast, Basiotribe
Geburtshilfe-Perforatorium, Kranioklast, Basiotrib
Obstetricia

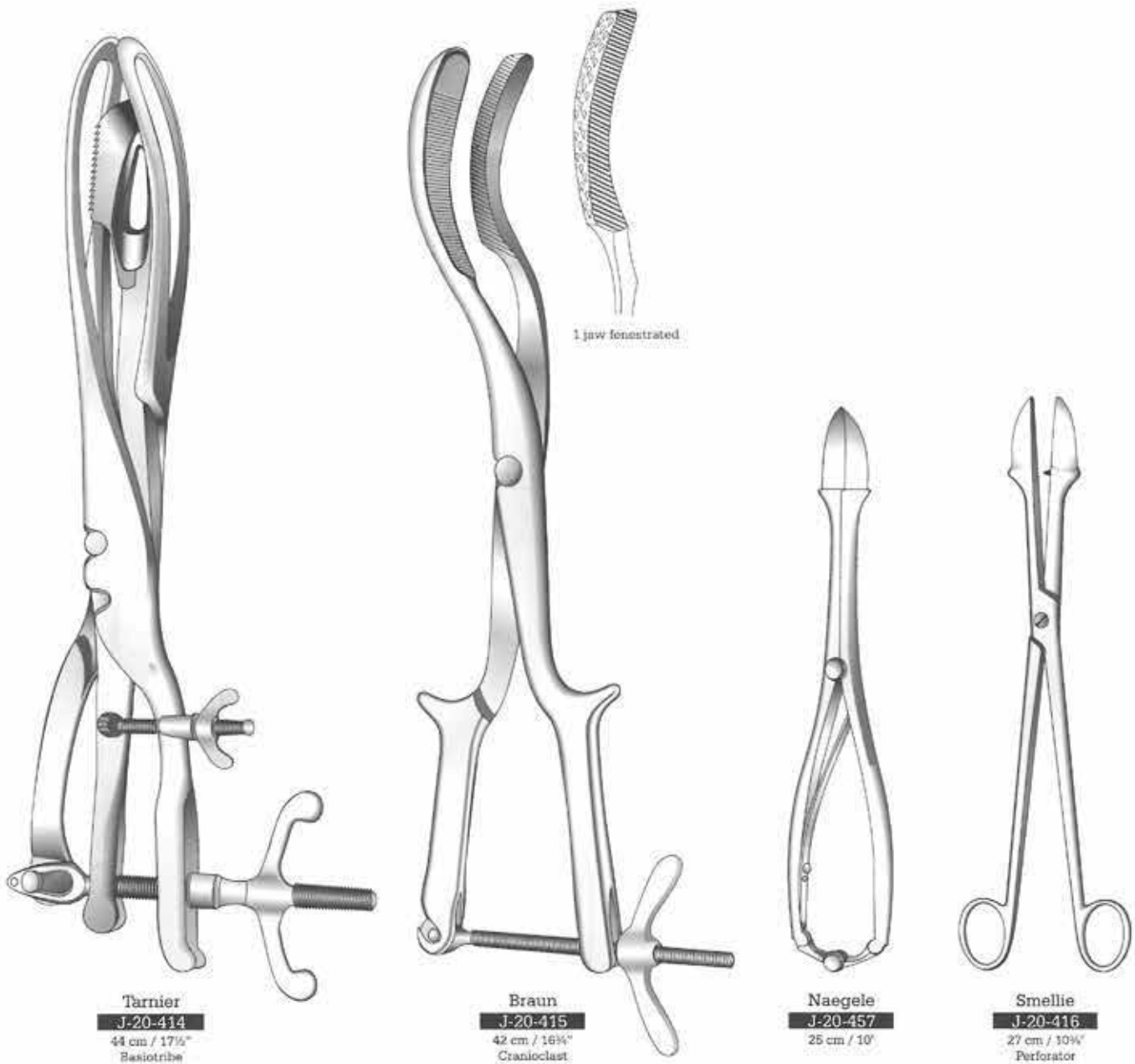

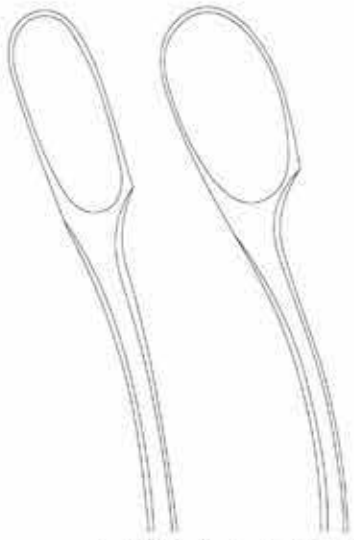

J-20-402

J-20-403

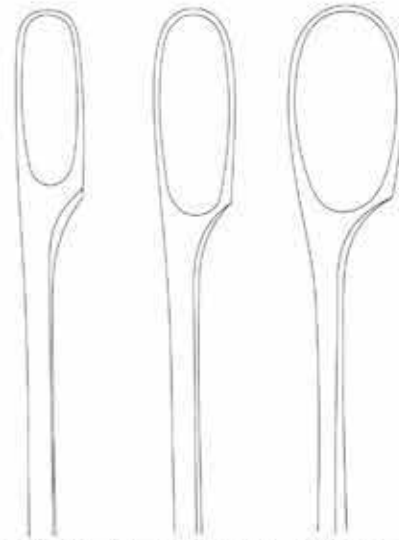

J-20-404

J-20-405

J-20-406

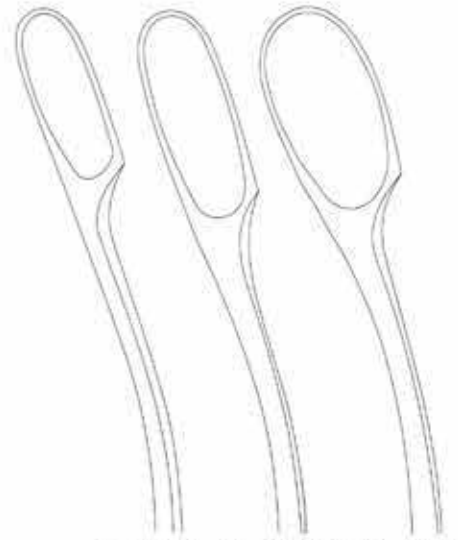

J-20-407

J-20-408

J-20-409

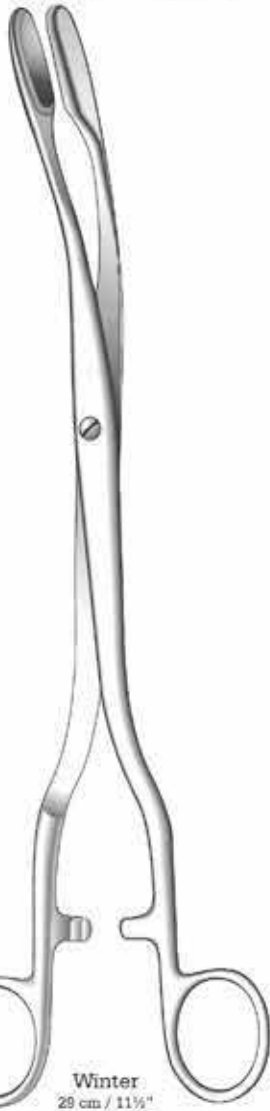

Winter
29 cm / 11 1/4"
With ratchet



Winter
29 cm / 11 1/4"



Winter
29 cm / 11 1/4"



Surgicon
J-20-396
28.5 cm / 11 1/2"
With protecting cap

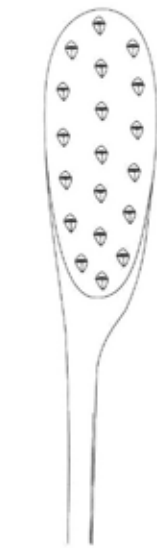

J-20-397
Straight



J-20-4697
Curved

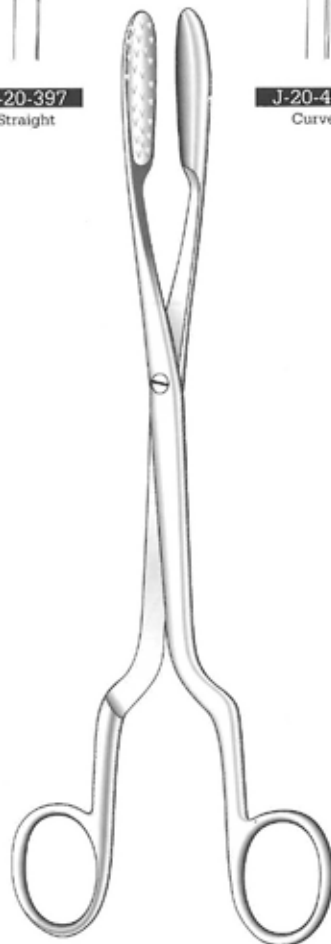

Lewkowitz
24.5 cm / 9 3/4"

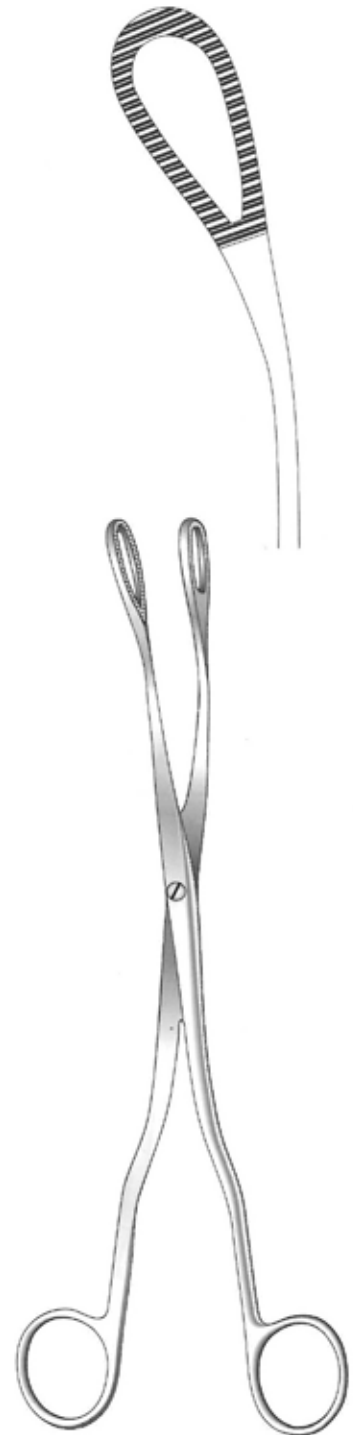

Mc clintock
J-20-398
24 cm / 9 1/2"



Saenger
J-20-399
28.5 cm / 10 3/4"

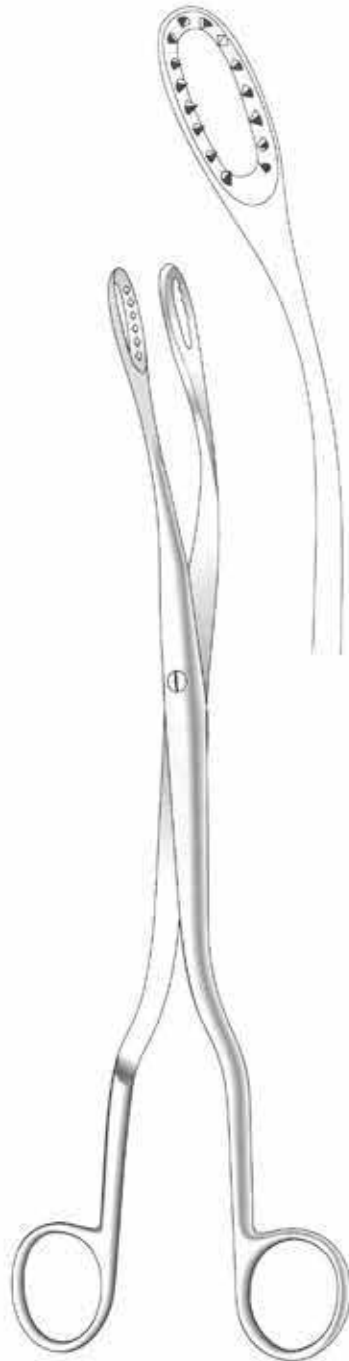

Saenger
J-20-400
28.5 cm / 11 1/4"

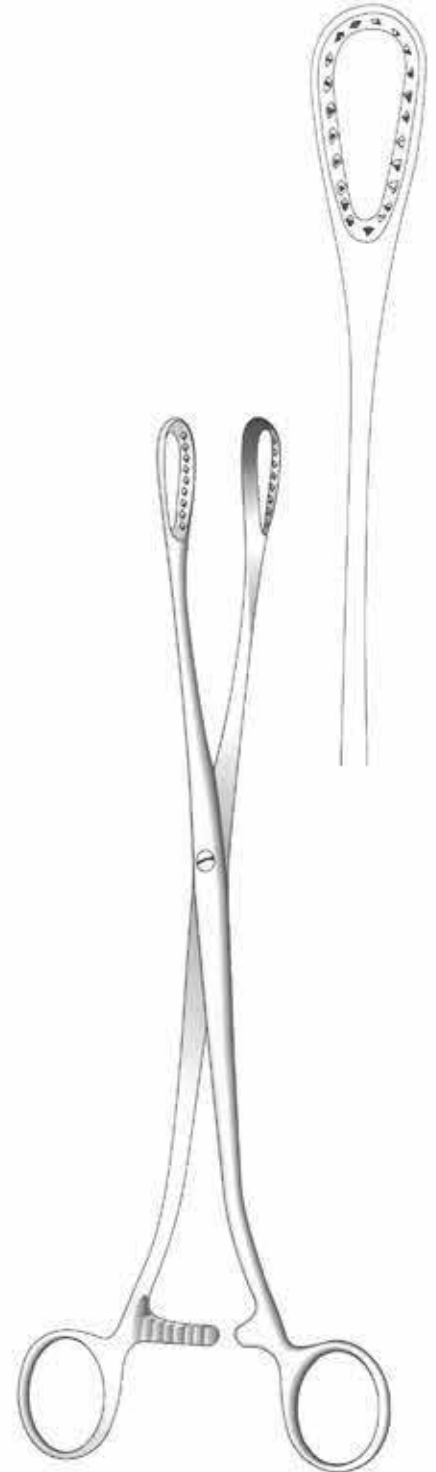

Saenger
J-20-401
27.5 cm / 10 3/4"

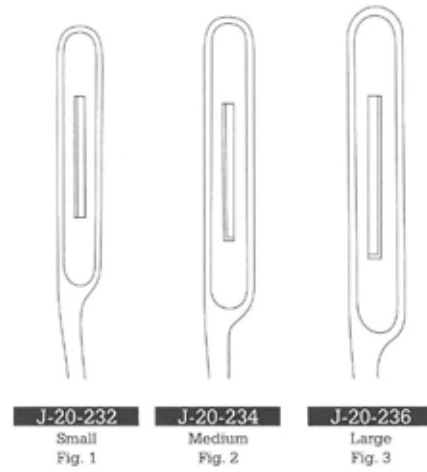
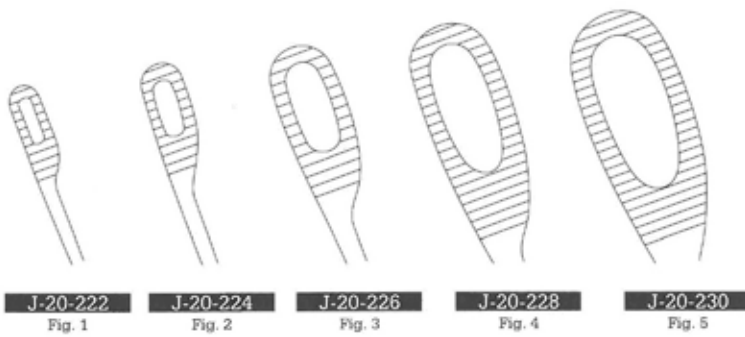

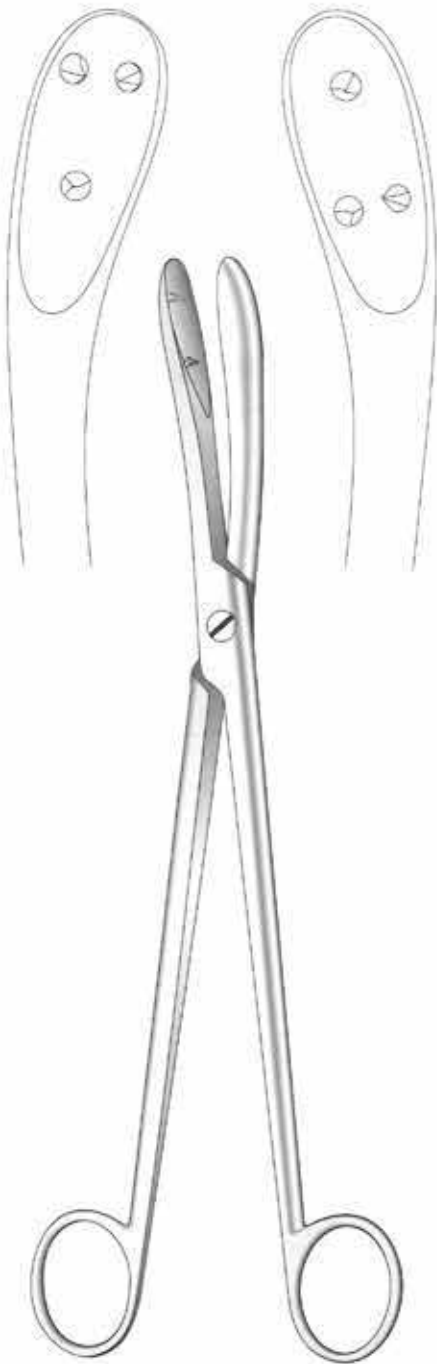

Boer
J-20-410
 29 cm / 11½"
 Craniotomy forceps



Braun
J-20-411
 32.5 cm / 13"
 Decapitating hook

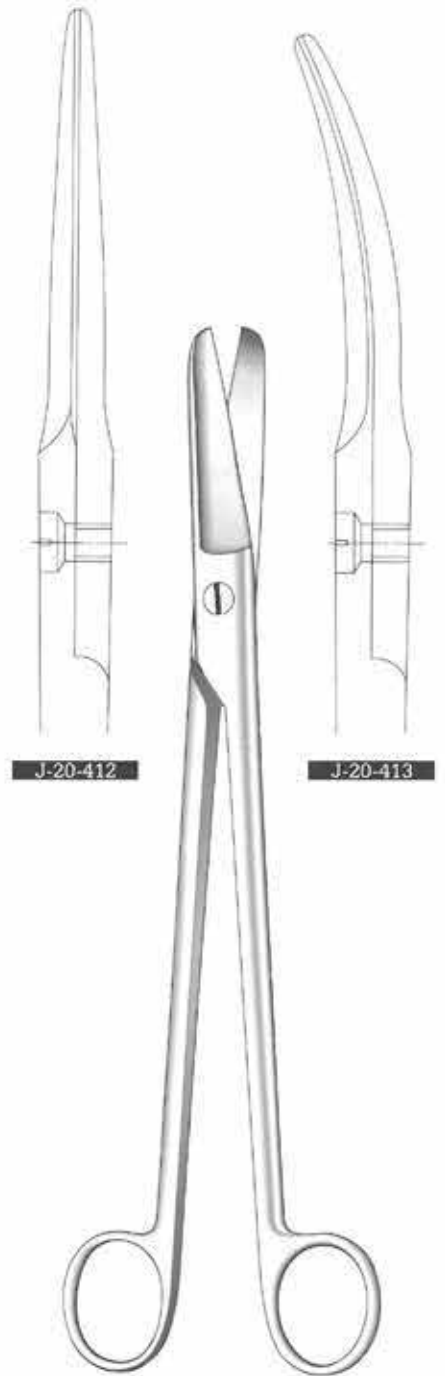

Dubios
 27.5 cm / 10¾"
 Decapitating (embryotomy) scissors

Gynecology

Obstetrics, Scalp Flap Forceps
Geburtshilfe, Kopfsch Wartenzangen
Obstetrique, Pinzas Para Paricraneo



Sellheim
J-20-418
30 cm / 12"
Obstetric lever

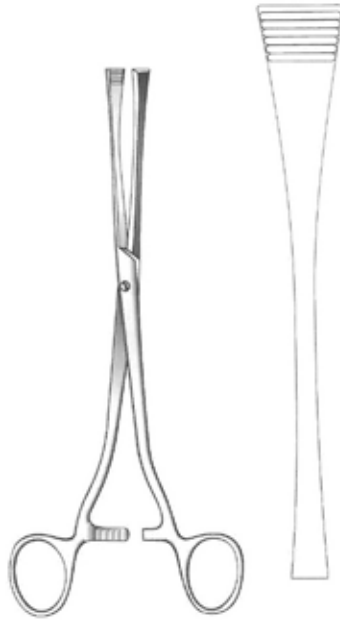

Green-Armytage
J-20-417
22 cm / 8 1/2"
Caesarean section haemostatic forceps,
for edges of the transverse incision in the
lower segment



Willet
J-17-188
19 cm / 7 1/2"
Scalp flap forceps

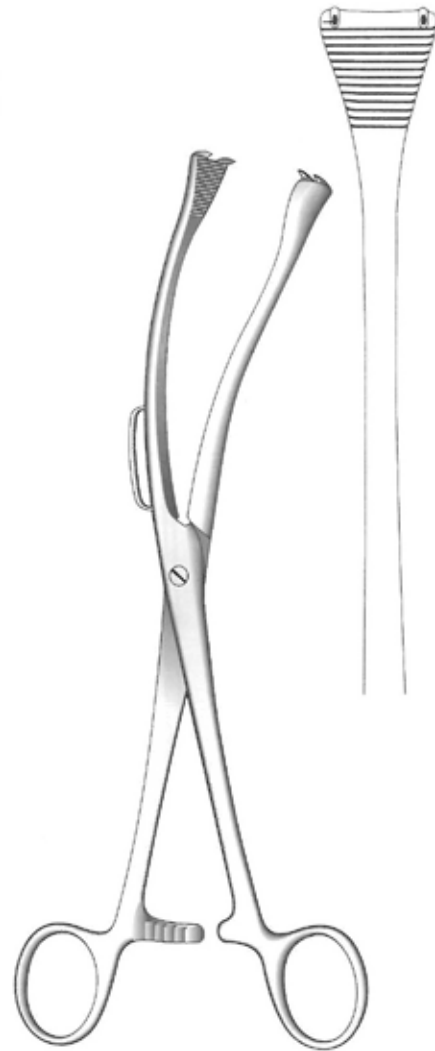

Gauss
J-20-419
26 cm / 10 1/4"
Scalp flap forceps



Gyneco

- J-20-4350 4 mm Ø
- J-20-4355 6 mm Ø
- J-20-4360 8 mm Ø
- J-20-4365 10 mm Ø
- J-20-4370 12 mm Ø
- J-20-4375 14 mm Ø
- J-20-4380 16 mm Ø



Smellie
 J-20-458
 33 cm / 13"



Wallich
 J-20-459
 42 cm / 16 1/2"



- J-20-4400 12 mm
 - J-20-4410 14 mm
 - J-20-4420 16 mm
 - J-20-4430 20 mm
- Blunt

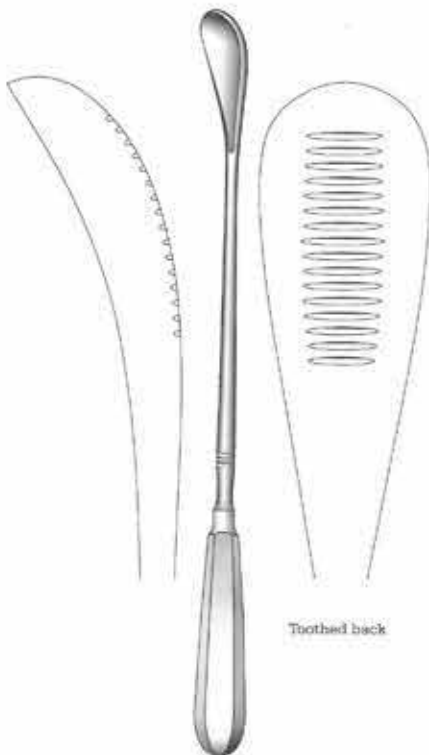

Cuzzi
 30 cm / 12"



J-20-460
 14.5 mm
 Blunt



J-20-461
 18 mm
 Blunt



J-20-462
 21 mm
 Blunt



Danis
 J-20-4450
 24 cm / 9 1/2"