





ARTERY FORCEPS



 www.convertualinterlogic.com

 +234 8033200998
+234 8180003461

 enquiries@convertualinterlogic.com

 1 Anu Crescent, Off Ado-Badore Road,
Ajah, Lagos, Nigeria

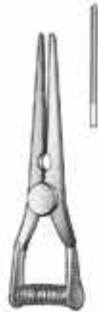

J-17-001
3.5 cm / 1½"



J-17-002
3.5 cm / 1½"



J-17-003
4.5 cm / 1¾"



J-17-004
4.5 cm / 1¾"



Dieffenbach
J-17-005 3.8 cm / 1½"
J-17-805 4.8 cm / 2"



Dieffenbach
J-17-006
J-17-806



Dieffenbach
J-17-007
5.8 cm / 2¼"



Dieffenbach
J-17-807
5.8 cm / 2¼"



J-17-008 5 cm / 2"
J-17-811 6.5 cm / 2½"
J-17-812 7.5 cm / 3"

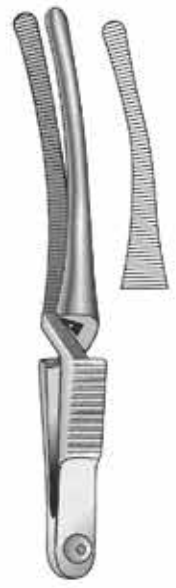

J-17-010
J-17-011
J-17-012



Halsted-Mosquito
Normal



Normal

J-17-500	9 cm / 3½"
J-17-017	10 cm / 4"
J-17-502	12 cm / 4¾"
J-17-021	12.5 cm / 5"
J-17-033	18 cm / 7"
J-17-037	21 cm / 8¼"



Normal

J-17-506	
J-17-018	
J-17-508	
J-17-022	
J-17-034	
J-17-038	



Normal

J-17-512	9 cm / 3½"
J-17-019	10 cm / 4"
J-17-514	12 cm / 4¾"
J-17-023	12.5 cm / 5"
J-17-035	18 cm / 7"
J-17-039	21 cm / 8¼"
1:2 Teeth	



Normal

J-17-518	
J-17-020	
J-17-520	
J-17-024	
J-17-036	
J-17-040	
1:2 Teeth	

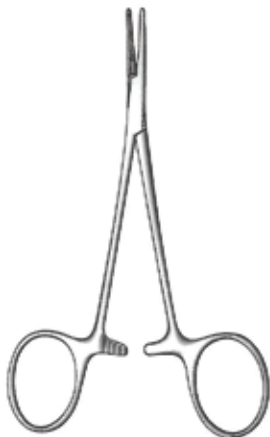

Micro-Mosquito



Micro

J-17-530	9 cm / 3½"
J-17-025	10 cm / 4"
J-17-026	12 cm / 4¾"



Micro

J-17-531	
J-17-027	
J-17-028	



Micro

J-17-532	9 cm / 3½"
J-17-029	10 cm / 4"
J-17-030	12 cm / 4¾"
1:2 Teeth	



Micro

J-17-533	
J-17-031	
J-17-032	
1:2 Teeth	

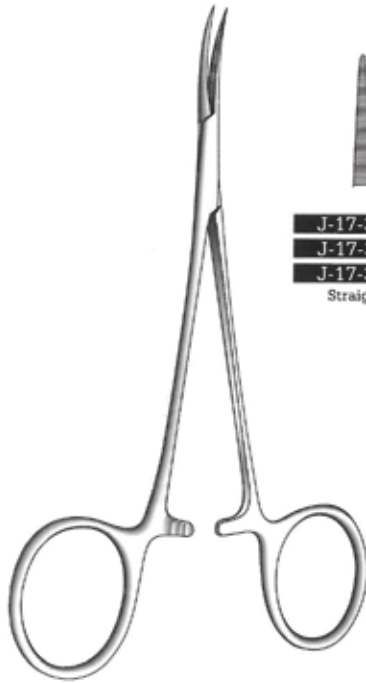

Mosquito
 Extra extra micro

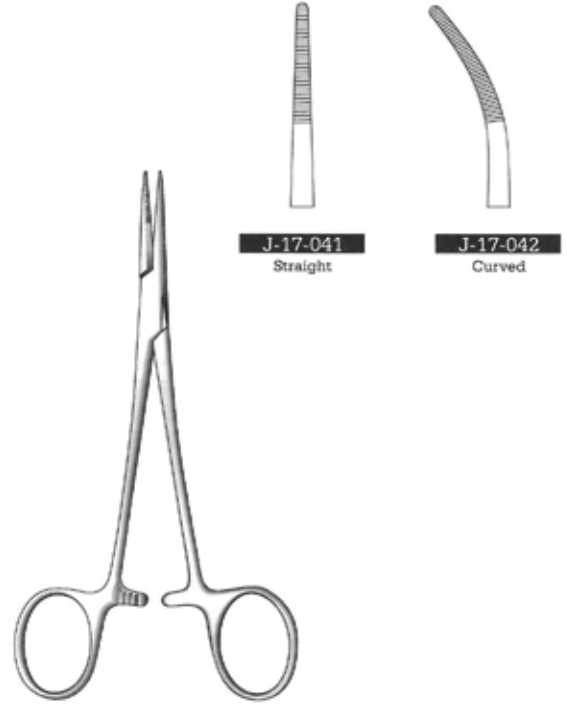
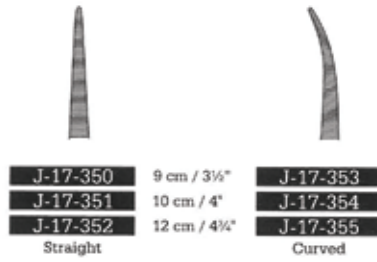

Providence-Hospital
 14 cm / 5½"



Carrel
J-17-014
 10 cm / 4"

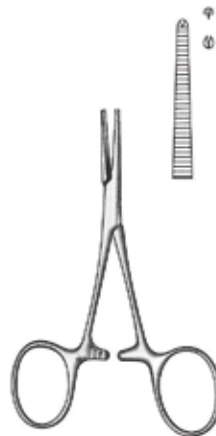

Terrier
J-17-016
 10 cm / 4"
 1:2 Teeth



Terrier
J-17-440
 12 cm / 4¾"



Kelly
 14 cm / 5½"

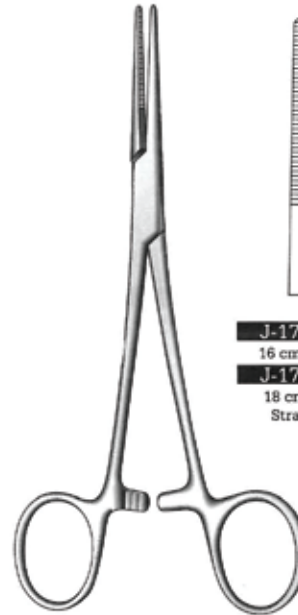
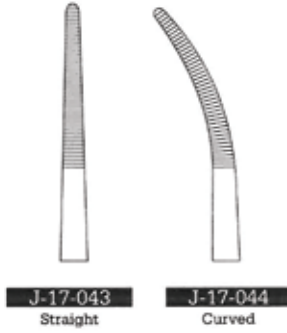

Kelly-Rankin

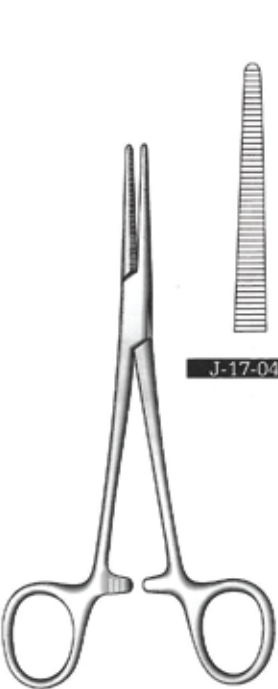
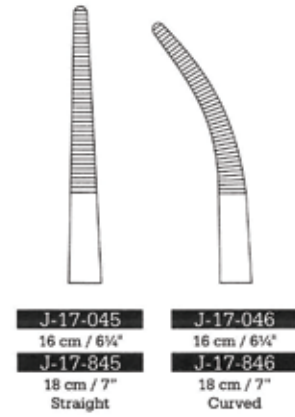

Crile
 14 cm / 5½"

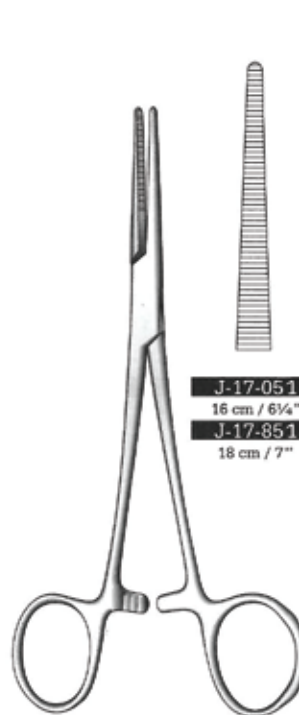
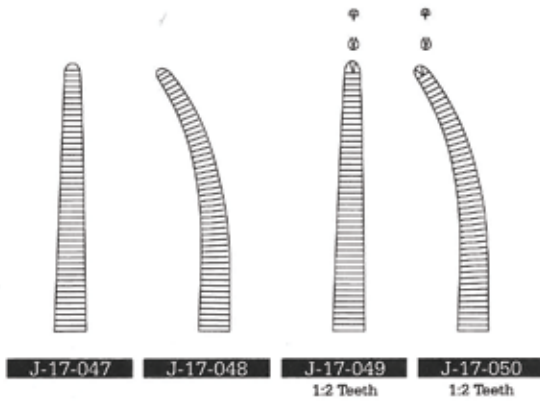

Crile-Rankin

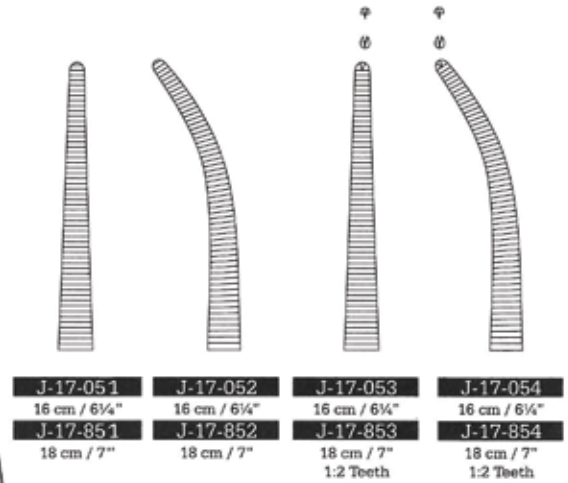

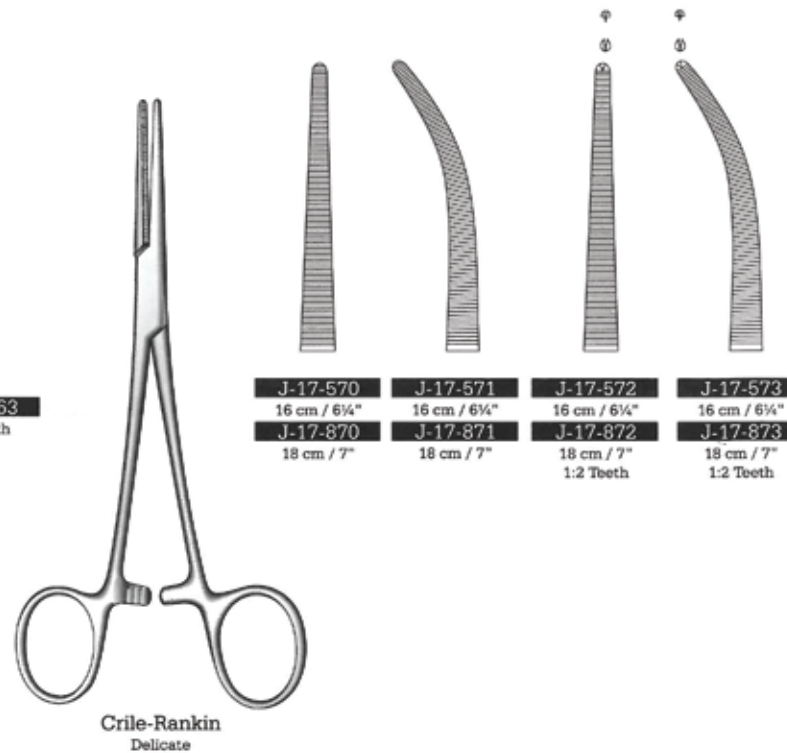
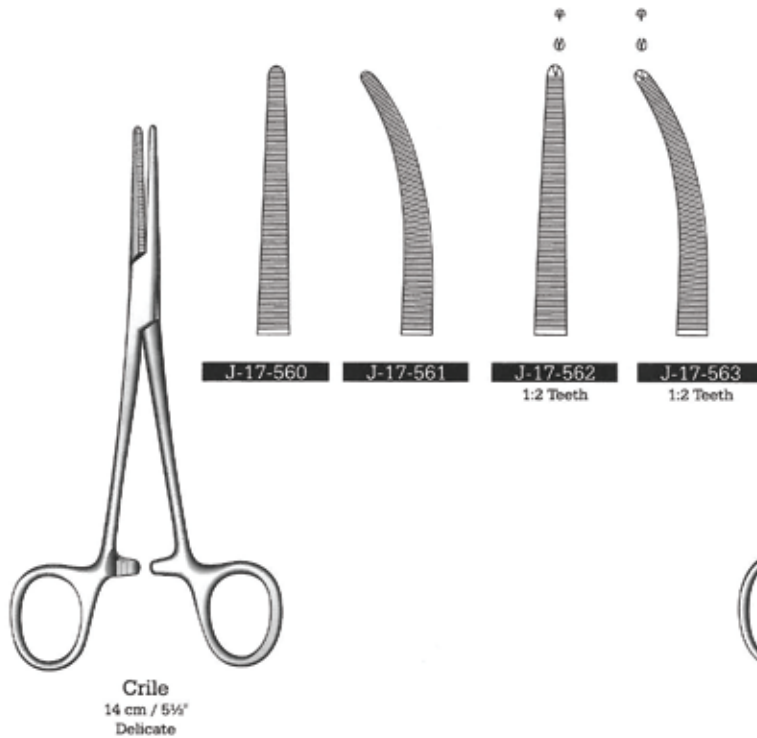
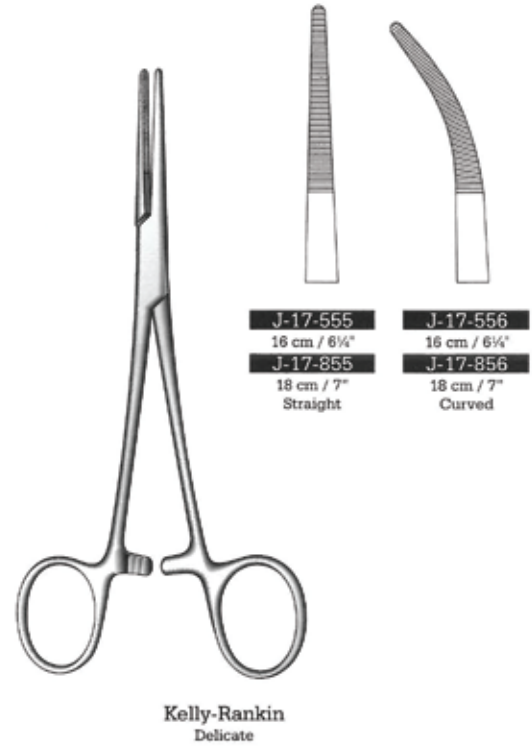
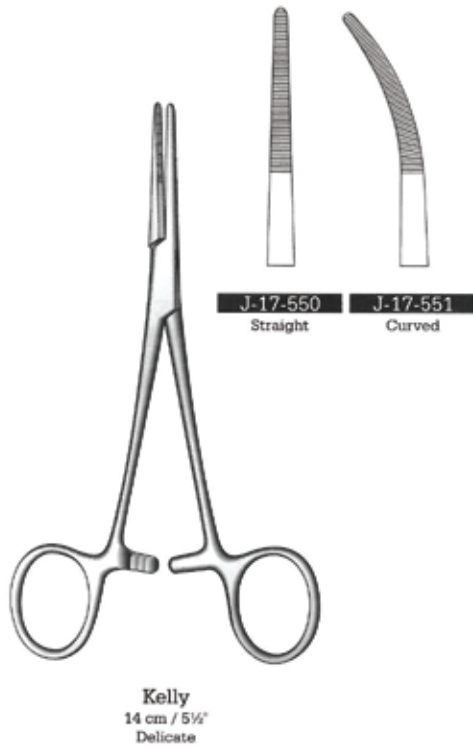

Artery Forceps
Arterienklemmen
Pinzas Hemostaticas

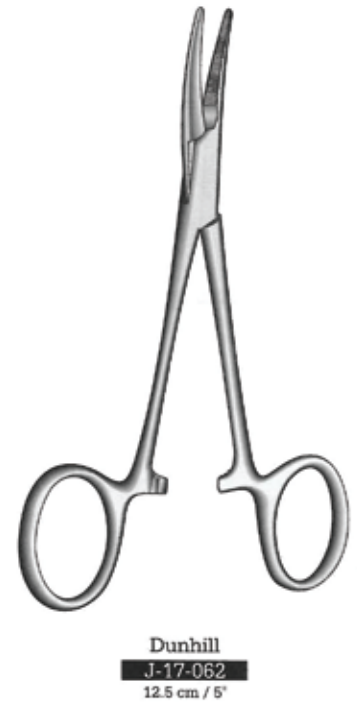
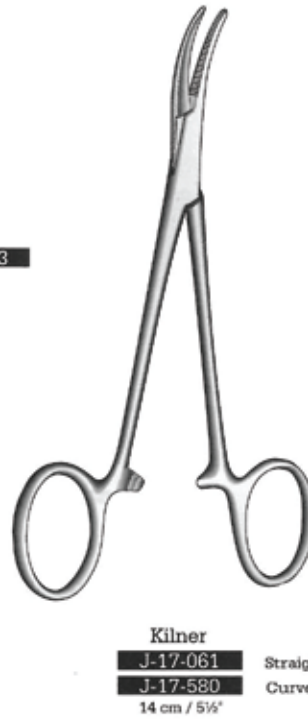
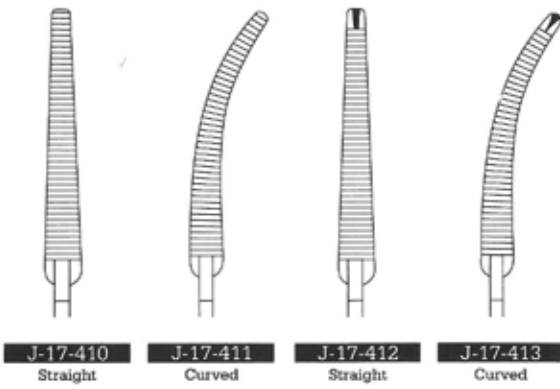
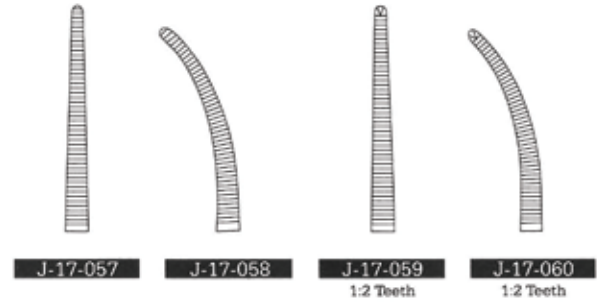
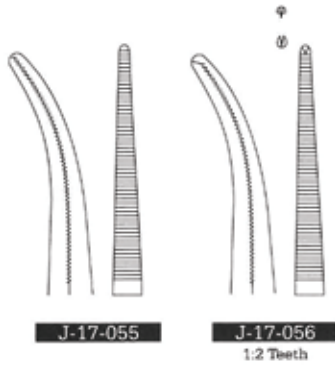

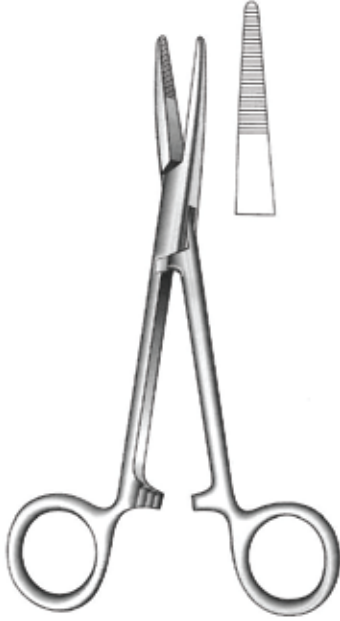

Grey-Turner
J-17-063 Straight
J-17-064 Curved
 15 cm / 6"

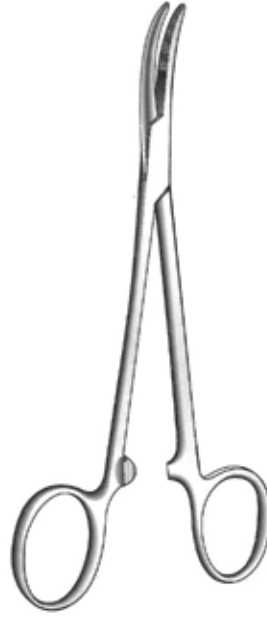

Cairns
J-17-065 Straight
J-17-590 Curved
 14.5 cm / 5 3/4"

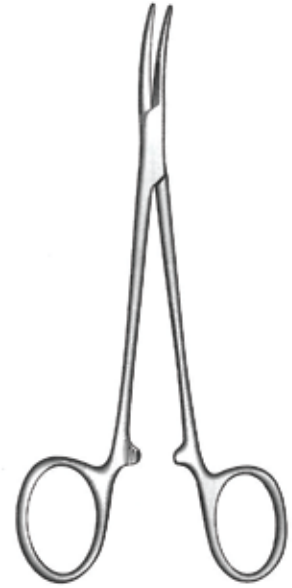

Cushing
J-17-066 Straight
J-17-600 Curved
 14.5 cm / 5 3/4"

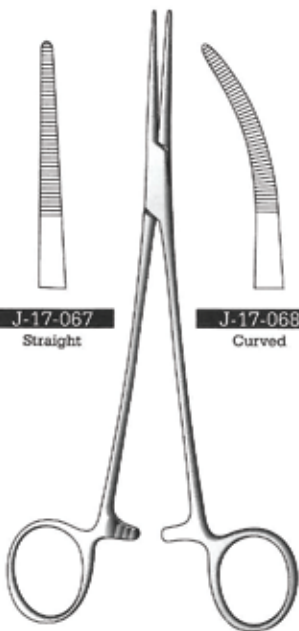

J-17-067 Straight
J-17-068 Curved

Birkett
 18.5 cm / 7 1/4"

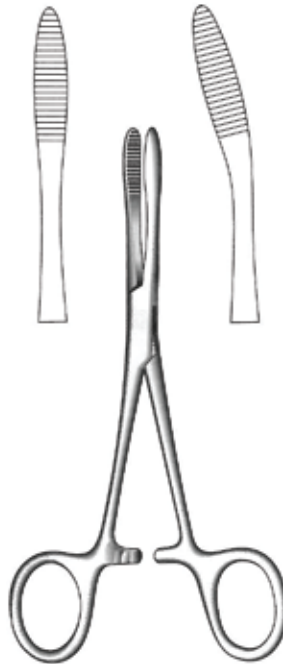

Pean
J-17-069 12.5 cm / 5" **J-17-075**
J-17-070 14 cm / 5 1/2" **J-17-076**
J-17-071 16 cm / 6 1/4" **J-17-077**
 Straight Curved

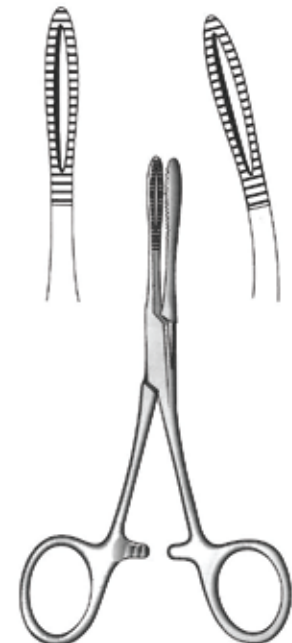

Kroenlien
J-17-078 Straight
J-17-610 Curved
 14 cm / 5 1/2"

Artery Forceps

Artery Forceps

Arterienklemmen

Pinzas Hemostaticas





Spencerwells

J-17-079	12.5 cm / 5"	J-17-084
J-17-080	15 cm / 6"	J-17-085
J-17-081	18 cm / 7"	J-17-086
J-17-082	20 cm / 8"	J-17-087
J-17-083	23 cm / 9"	J-17-088

Straight Curved

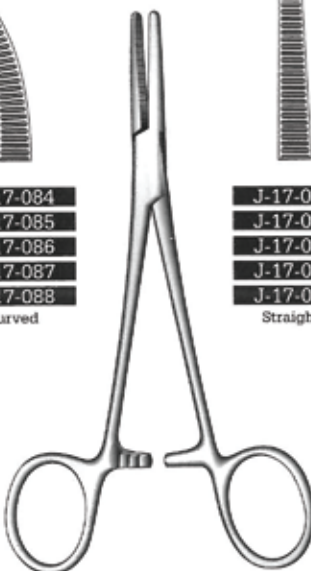

Spencer-Wells

J-17-089	12.5 cm / 5"	J-17-094
J-17-090	15 cm / 6"	J-17-095
J-17-091	18 cm / 7"	J-17-096
J-17-092	20 cm / 8"	J-17-097
J-17-093	23 cm / 9"	J-17-098

Straight Curved

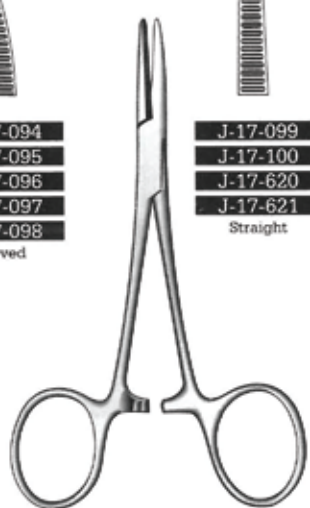

Jones

J-17-099	12.5 cm / 5"	J-17-360
J-17-100	15 cm / 6"	J-17-361
J-17-620	18 cm / 7"	J-17-362
J-17-621	20 cm / 8"	J-17-363

Straight Curved



Pean

J-17-370	13.5 cm / 5 1/4"	J-17-375
J-17-371	14.5 cm / 5 3/4"	J-17-376
J-17-372	17 cm / 6 3/4"	J-17-377

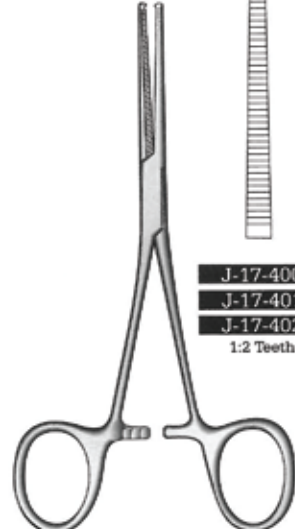

Kocher

J-17-400	13 cm / 5"	J-17-405
J-17-401	14 cm / 5 1/2"	J-17-406
J-17-402	16 cm / 6 1/4"	J-17-407

1:2 Teeth 1:2 Teeth

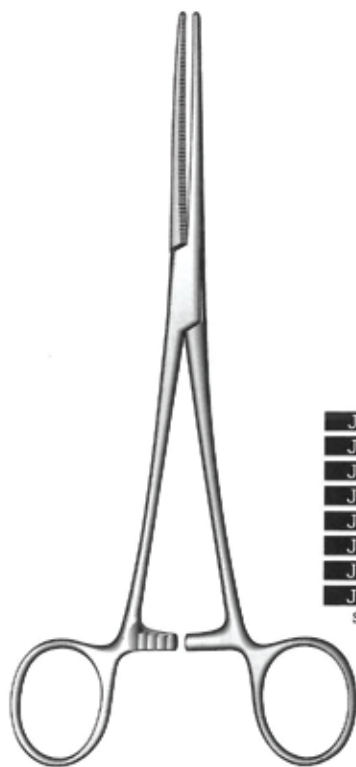

Rochester-Pean

J-17-101	14 cm / 5½"	J-17-109
J-17-102	16 cm / 6¼"	J-17-110
J-17-103	18 cm / 7"	J-17-111
J-17-104	20 cm / 8"	J-17-112
J-17-105	22 cm / 8¾"	J-17-113
J-17-106	24 cm / 9½"	J-17-114
J-17-107	26 cm / 10½"	J-17-115
J-17-108	30 cm / 12"	J-17-116
Straight		Curved

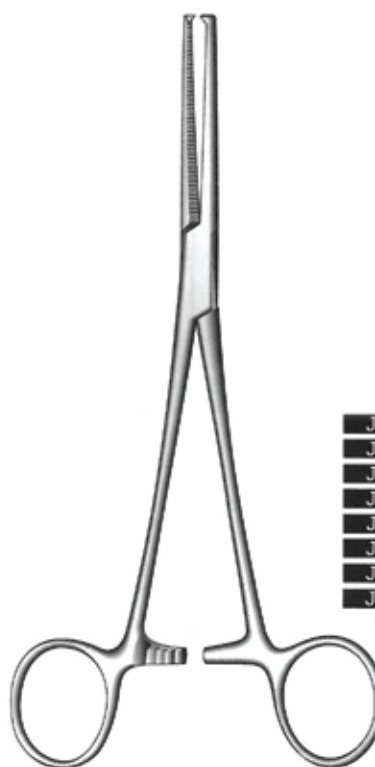

Rochester-Ochsner
1:2 Teeth

J-17-117	14 cm / 5½"	J-17-125
J-17-118	16 cm / 6¼"	J-17-126
J-17-119	18 cm / 7"	J-17-127
J-17-120	20 cm / 8"	J-17-128
J-17-121	22 cm / 8¾"	J-17-129
J-17-122	24 cm / 9½"	J-17-130
J-17-123	26 cm / 10½"	J-17-131
J-17-124	30 cm / 12"	J-17-132
Straight		Curved

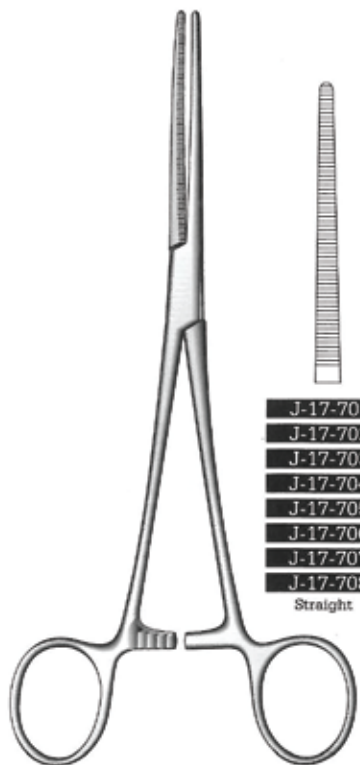

Rochester-Pean
Delicate

J-17-701	14 cm / 5½"	J-17-709
J-17-702	16 cm / 6¼"	J-17-710
J-17-703	18 cm / 7"	J-17-711
J-17-704	20 cm / 8"	J-17-712
J-17-705	22 cm / 8¾"	J-17-713
J-17-706	24 cm / 9½"	J-17-714
J-17-707	26 cm / 10½"	J-17-715
J-17-708	30 cm / 12"	J-17-716
Straight		Curved

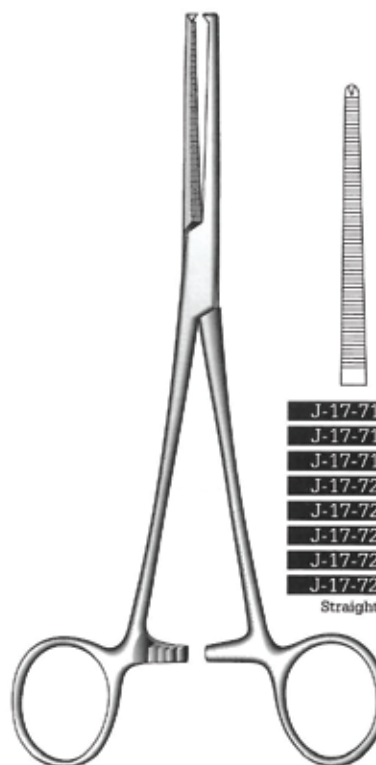

Rochester-Ochsner
1:2 Teeth, Delicate

J-17-717	14 cm / 5½"	J-17-725
J-17-718	16 cm / 6¼"	J-17-726
J-17-719	18 cm / 7"	J-17-727
J-17-720	20 cm / 8"	J-17-728
J-17-721	22 cm / 8¾"	J-17-729
J-17-722	24 cm / 9½"	J-17-730
J-17-723	26 cm / 10½"	J-17-731
J-17-724	30 cm / 12"	J-17-732
Straight		Curved

Artery Forceps
Artery Forceps
Arterienklemmen
Pinzas Hemostaticas

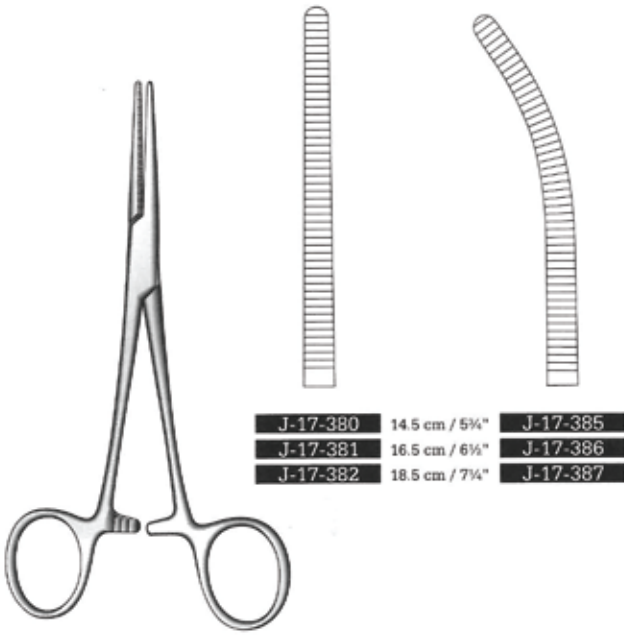

J-17-380	14.5 cm / 5 3/4"	J-17-385
J-17-381	16.5 cm / 6 1/2"	J-17-386
J-17-382	18.5 cm / 7 1/4"	J-17-387

Pean-Nippon

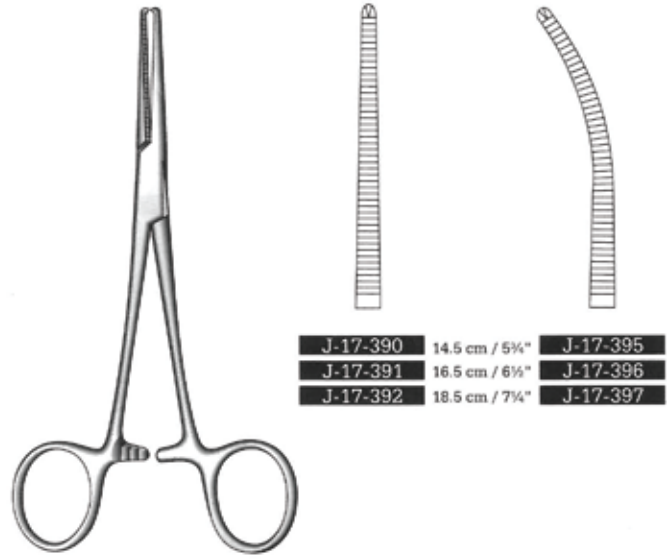

J-17-390	14.5 cm / 5 3/4"	J-17-395
J-17-391	16.5 cm / 6 1/2"	J-17-396
J-17-392	18.5 cm / 7 1/4"	J-17-397

Kocher-Nippon
1:2 Teeth



J-17-149	J-17-749
	1:2 Teeth

Dixon-Lovelace
16 cm / 6 1/4"

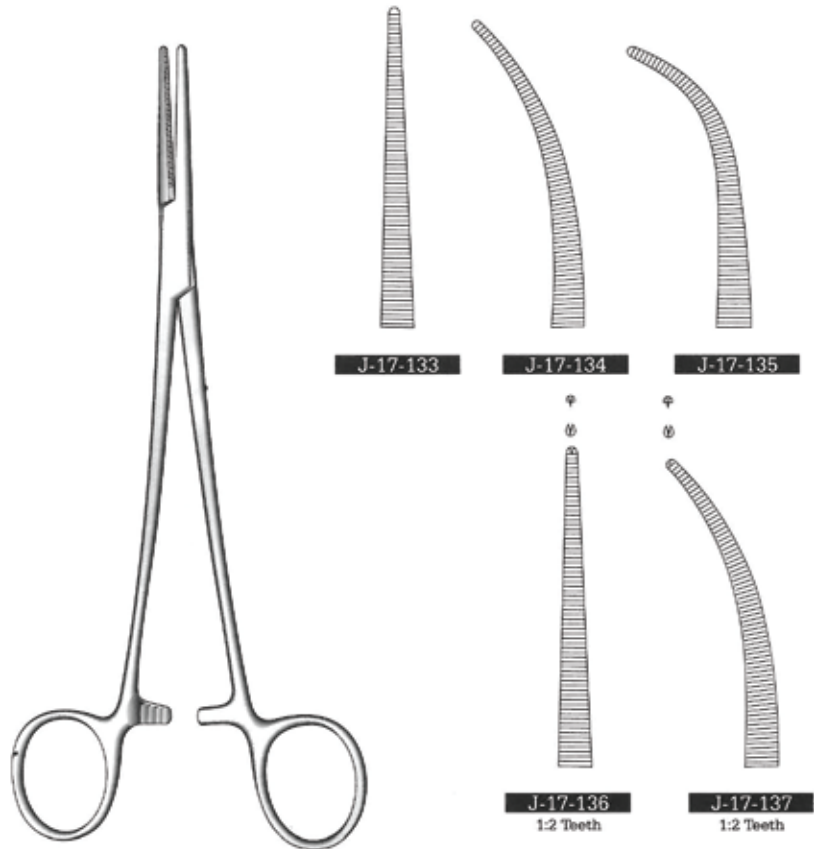

J-17-133	J-17-134	J-17-135
----------	----------	----------

J-17-136	J-17-137
1:2 Teeth	1:2 Teeth

Heiss
20 cm / 8"



Adson
18 cm / 7"

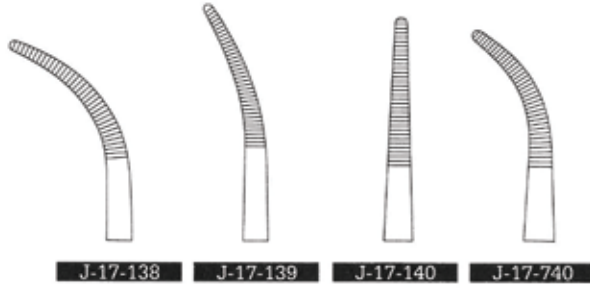

J-17-138 J-17-139 J-17-140 J-17-740

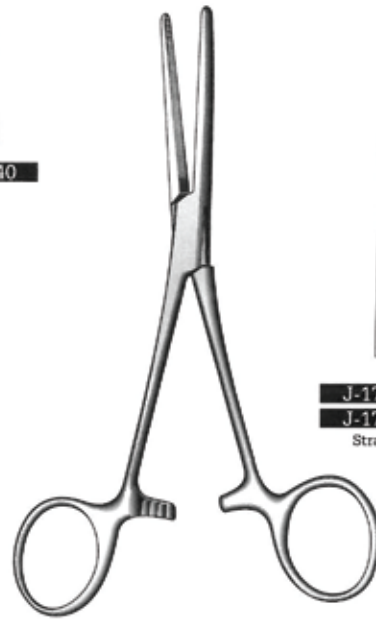

Rochester-Carmalt

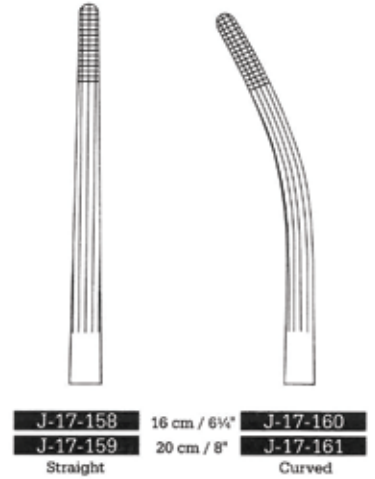

J-17-158 16 cm / 6 1/4" J-17-160
 J-17-159 20 cm / 8" J-17-161
 Straight Curved



Bengolea

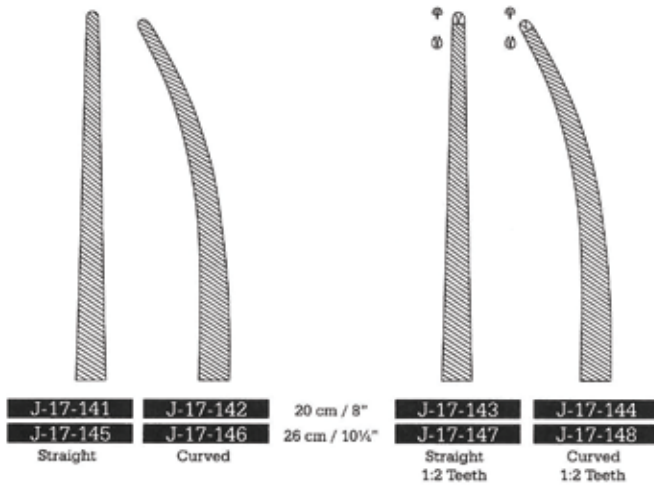

J-17-141 J-17-142 20 cm / 8" J-17-143 J-17-144
 J-17-145 J-17-146 26 cm / 10 1/4" J-17-147 J-17-148
 Straight Curved Straight 1:2 Teeth Curved 1:2 Teeth



Brainbridge

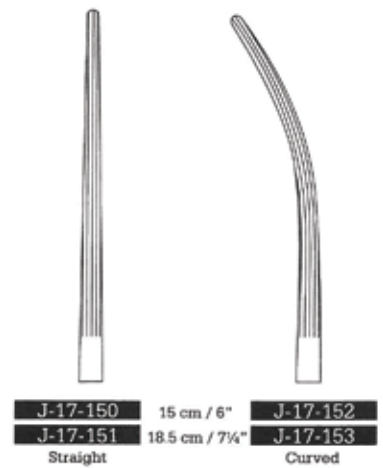

J-17-150 15 cm / 6" J-17-152
 J-17-151 18.5 cm / 7 1/4" J-17-153
 Straight Curved

Artery Forceps

Tissue, Organ Grasping Forceps

Gewebe und Organfasszangen

Pinzas para tejidos Y para sacar organos



Chaput

J-17-166 13 cm / 5"
J-17-766 16 cm / 6¼"



Tuffier

J-17-167
13 cm / 5"



Porrier

J-17-168 12.5 cm / 5"
J-17-169 18 cm / 7"

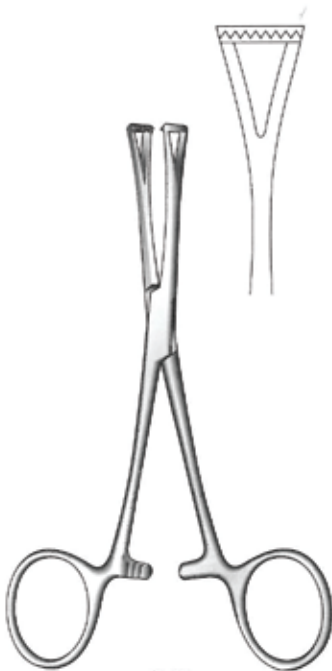

Collin

J-17-170
14 cm / 5½"



Lane

J-17-171	12.5 cm / 5"	J-17-174
J-17-172	15 cm / 6"	J-17-175
J-17-173	19 cm / 7½"	J-17-176
1:2 Teeth		2:3 Teeth



Pennington

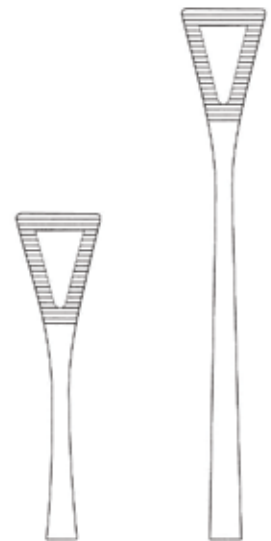

J-17-177
15.5 cm / 6"

J-17-178
20 cm / 8"



J-17-179

J-17-180

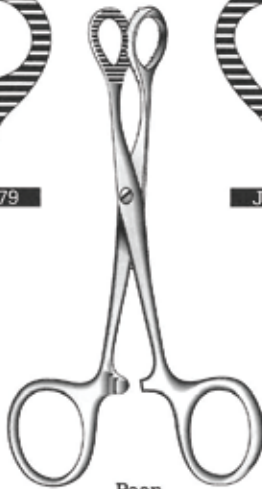

Pean
12 cm / 4 3/4"



Collin
J-17-181
16 cm / 6 1/4"



J-17-182

J-17-183

J-17-184



Hopfner
J-17-185
16 cm / 6 1/4"
Vessel clamp

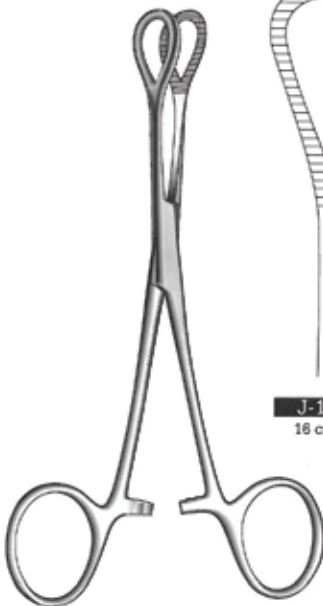

Coeur



J-17-420
18 cm / 6 3/4"



J-17-421 18 cm / 7"
J-17-422 20 cm / 8"
J-17-423 22 cm / 9"



Gregoire



J-17-430 16 cm / 6 1/4"
J-17-431 18 cm / 7"
J-17-432 20 cm / 8"
J-17-433 22 cm / 9"

Artery Forceps

Tissue, Organ Grasping Forceps & Angiotribes

Gewebe, Organfasszangen und Druckklemmen

Tejidos, Sacar organos Y para clamp de Persion progresiva

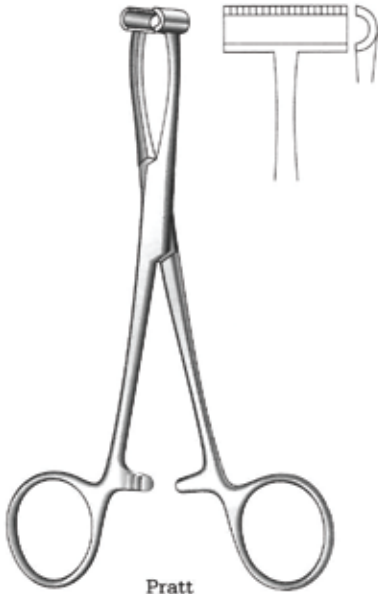

Pratt
J-17-186
15 cm / 6"

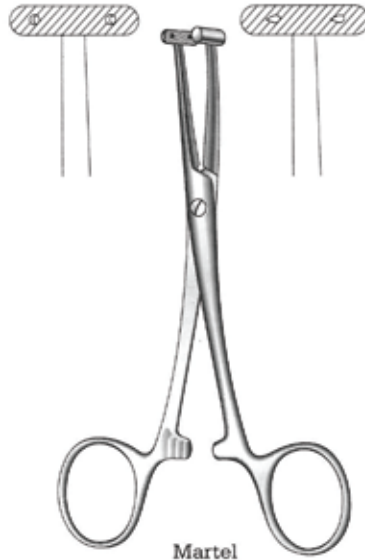

Martel
J-17-187
14 cm / 5 1/2"
Face lift forceps

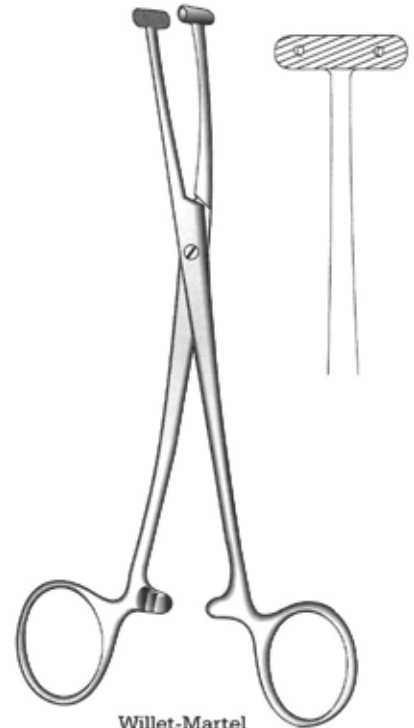

Willet-Martel
J-17-188
19 cm / 7 1/2"



Buie
J-17-189
21 cm / 8 1/4"



Fergusson

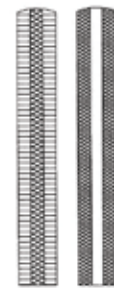

J-17-190
17 cm / 6 3/4"

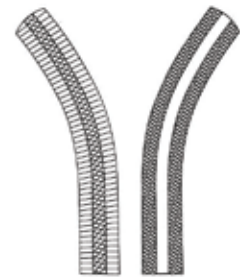

J-17-191
17 cm / 6 3/4"

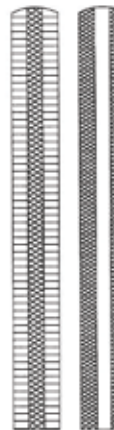

J-17-192
20 cm / 8"

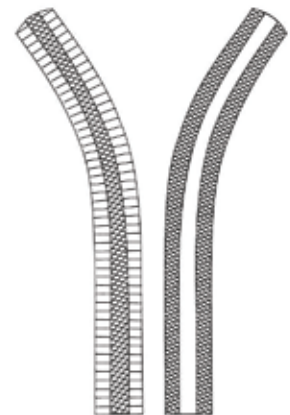

J-17-193
20 cm / 8"

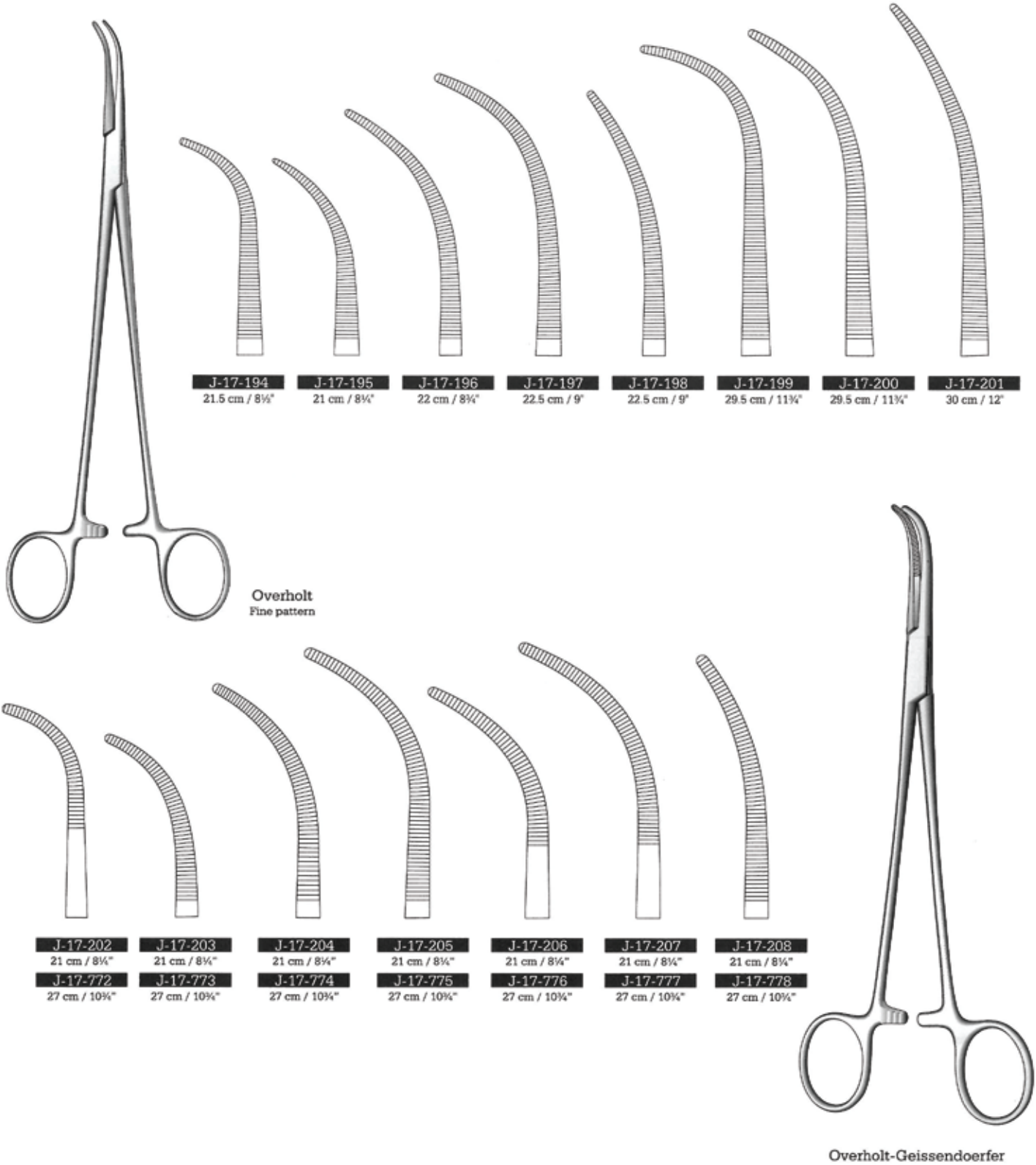

Artery Forceps

Dissecting & Ligature Forceps
Praparienklemmen, Arterienklemmen
Pinzas pra Preparacion y Ligadura

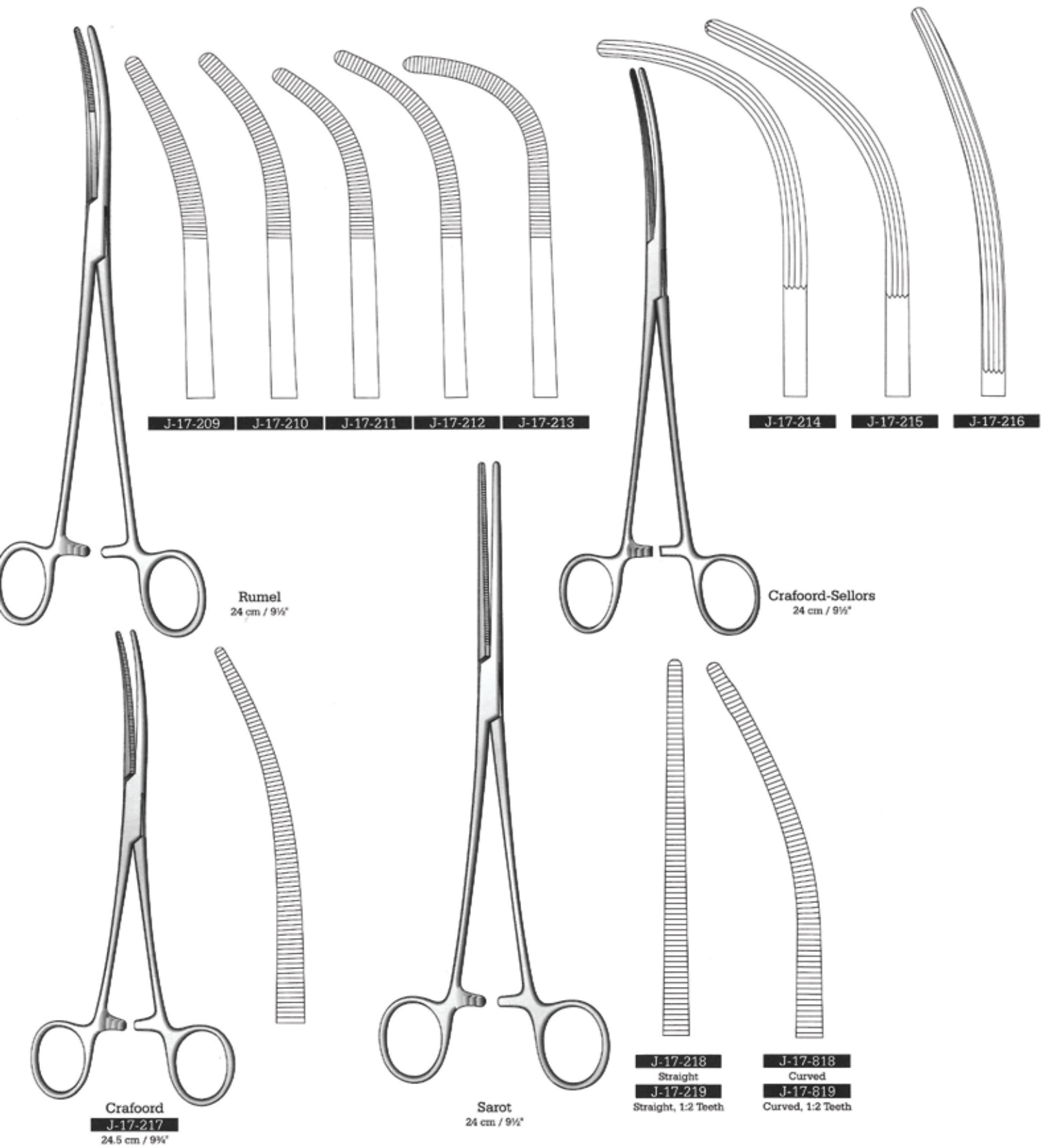



Roberts
 J-17-220 Straight
 J-17-221 Curved
 23 cm / 9"

Roberts
 22 cm / 8 3/4"



Gemini

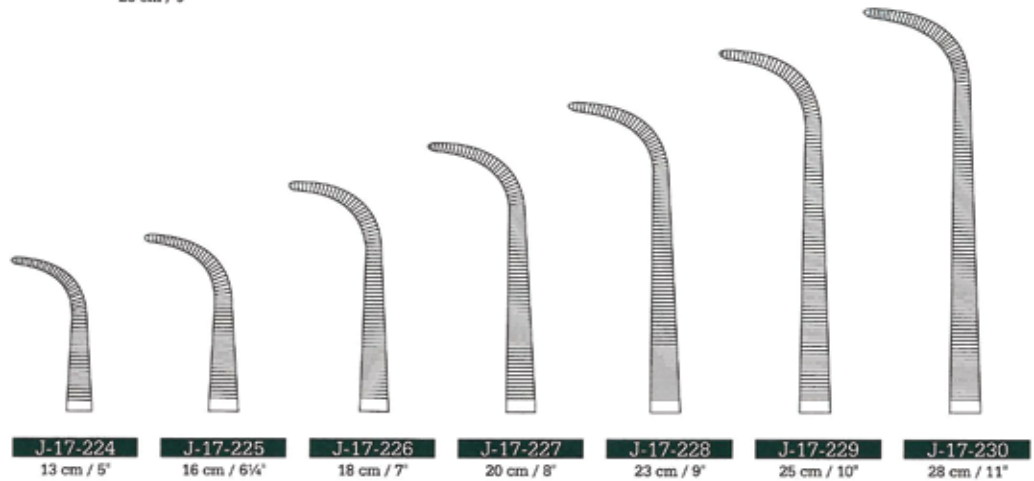

J-17-224 13 cm / 5" J-17-225 16 cm / 6 1/4" J-17-226 18 cm / 7" J-17-227 20 cm / 8" J-17-228 23 cm / 9" J-17-229 25 cm / 10" J-17-230 28 cm / 11"

Artery Forceps

Dissecting & Ligature Forceps

Praparienklemmen, Arterienklemmen

Pinzas pra Preparacion y Ligadura



Johns Hopkins
J-17-231
20 cm / 8"



Lawrence
J-17-232
27 cm / 10 1/2"

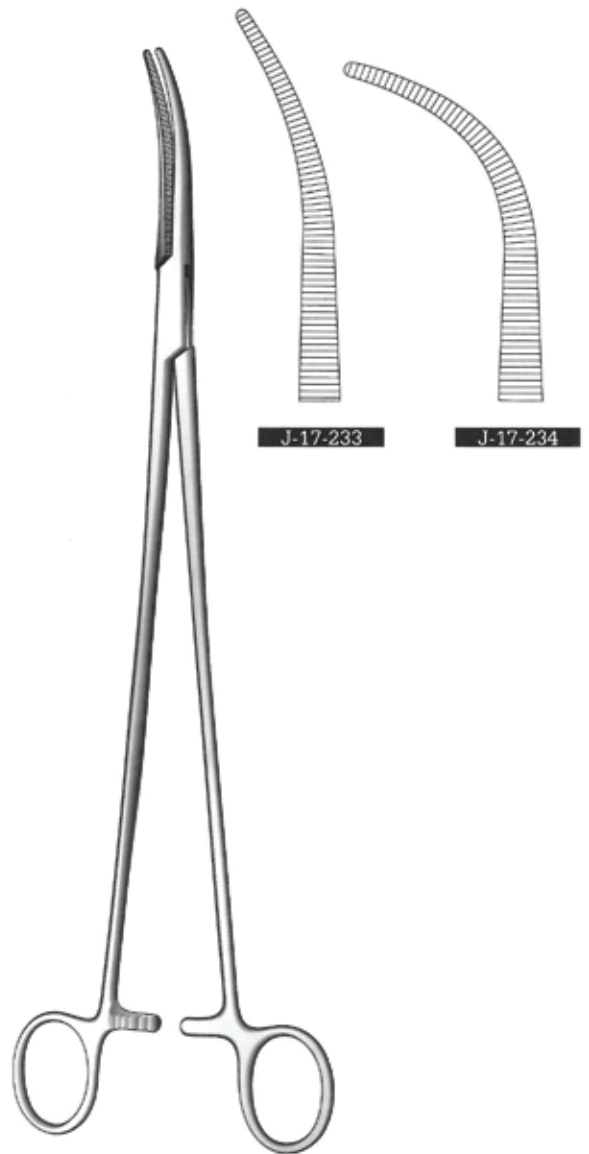

Zenker
29.5 cm / 11 1/2"

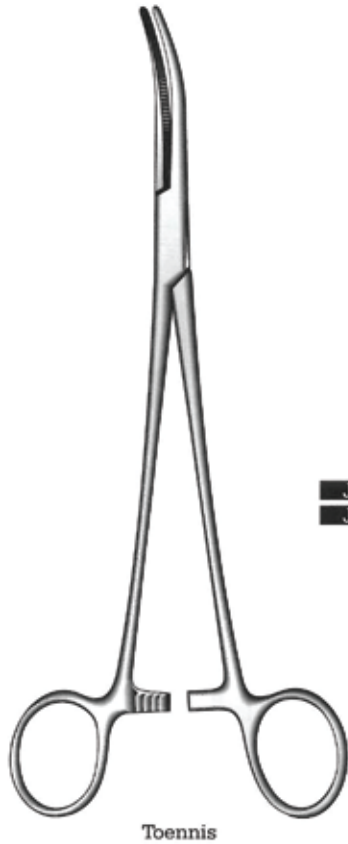

Toennis

J-17-235 21 cm / 8¼"
 J-17-236 26 cm / 10¼"

J-17-237
 J-17-238

J-17-239 21 cm / 8¼"
 J-17-240 26 cm / 10¼"
 1:2 Teeth

J-17-241
 J-17-242
 1:2 Teeth

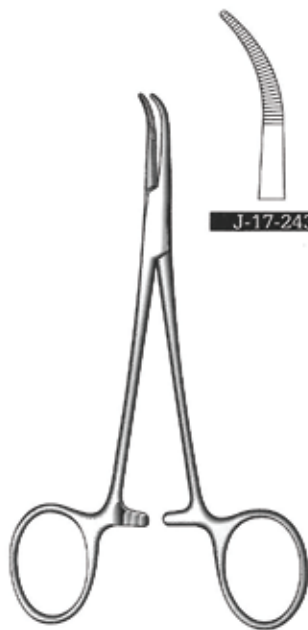

Baby-Mixer
 14 cm / 5½"

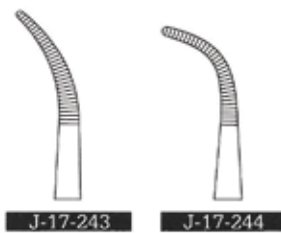

J-17-243 J-17-244



Mixer
 14 cm / 5½"



J-17-245

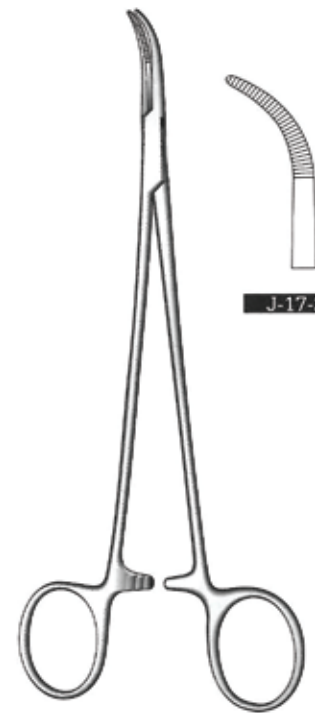

Baby-Mixer
 18 cm / 7"



J-17-246

Artery Forceps

Dissecting & Ligature Forceps

Praparienklemmen

Pinzas pra Preparacion y Ligadura

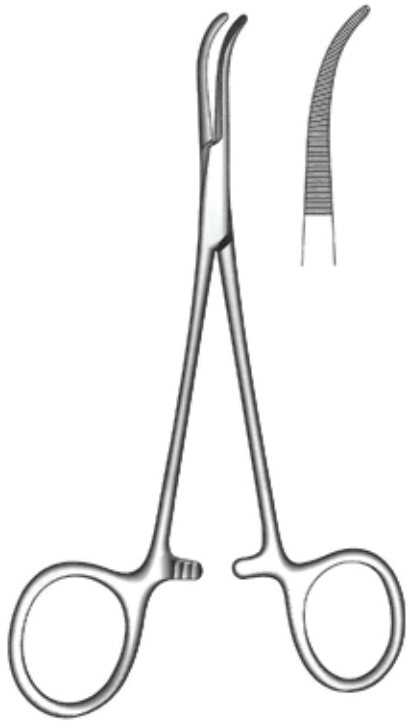

Jacobson Mixer Forceps

J-17-450
15.5 cm / 6"
Extra extra delicate

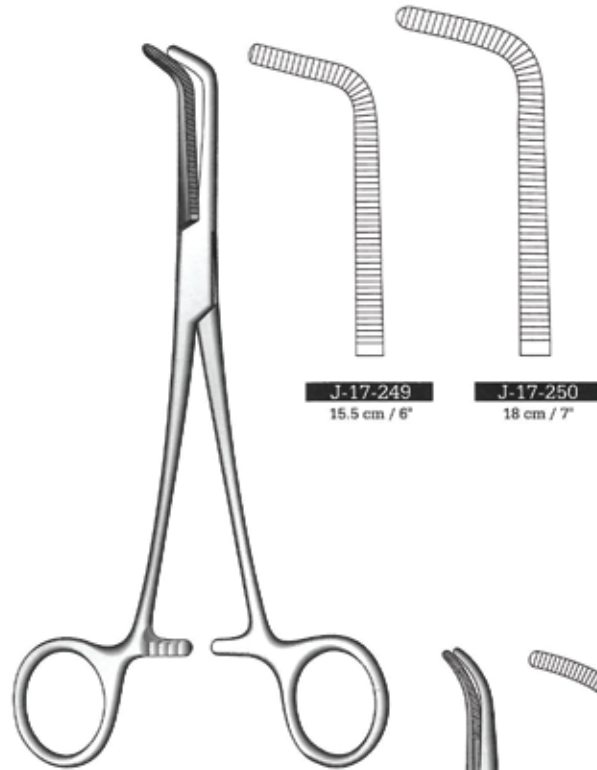

J-17-249
15.5 cm / 6"

J-17-250
18 cm / 7"

Mixer



Mixer
J-17-247
22 cm / 8 3/4"

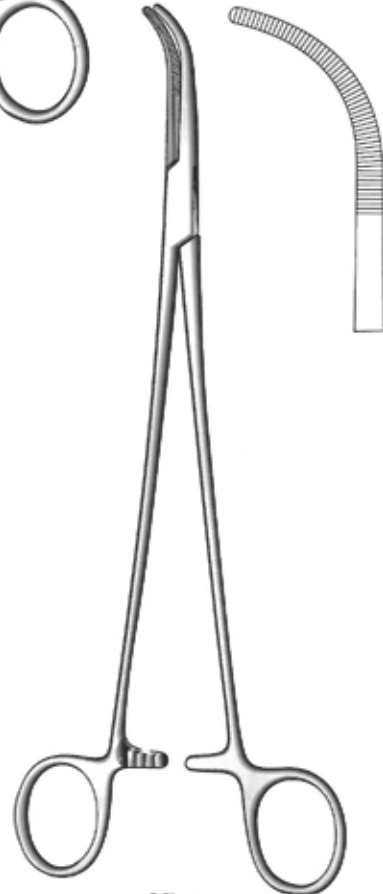

Mixer
J-17-248
23 cm / 9"



Mixer-O,Shaughnessy
J-17-251
 18 cm / 7"



Mixer

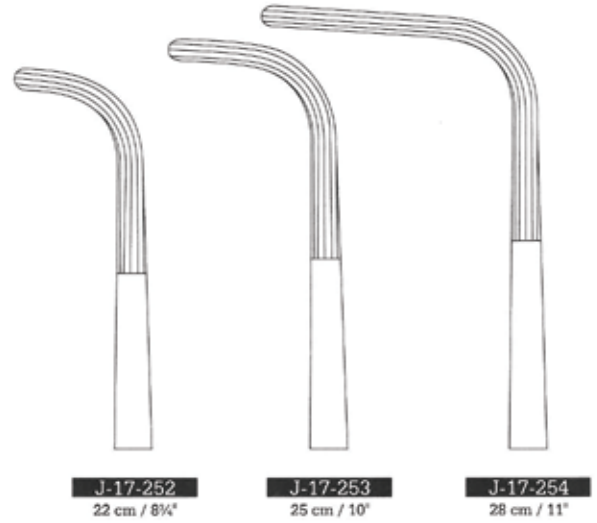

J-17-252
 22 cm / 8 3/4"

J-17-253
 25 cm / 10"

J-17-254
 28 cm / 11"

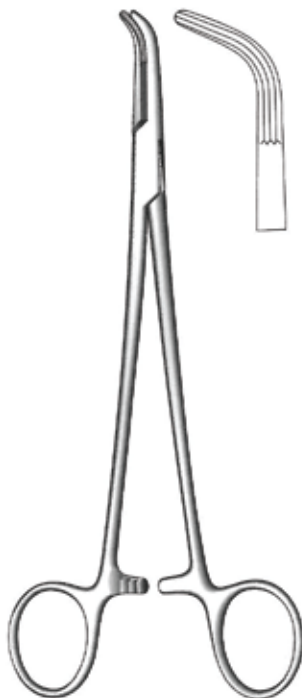

Lower
J-17-255
 18 cm / 7"



Lahey



J-17-256
 19 cm / 7 1/2"

J-17-257
 23 cm / 9"

Artery Forceps

Dissecting & Ligature Forceps, Haemostatic Forceps

Praparienklemmen, Arterienklemmen

Pinzas pra Preparacion y Ligadura, Pinzas hemostaticas



Finocchietto
J-17-258
24 cm / 9½"



Schnidt
19 cm / 7½"



J-17-261



J-17-262



Schnidt
19 cm / 7½"



J-17-263



J-17-264



Sawtell
18.5 cm / 7¼"



J-17-259



J-17-260

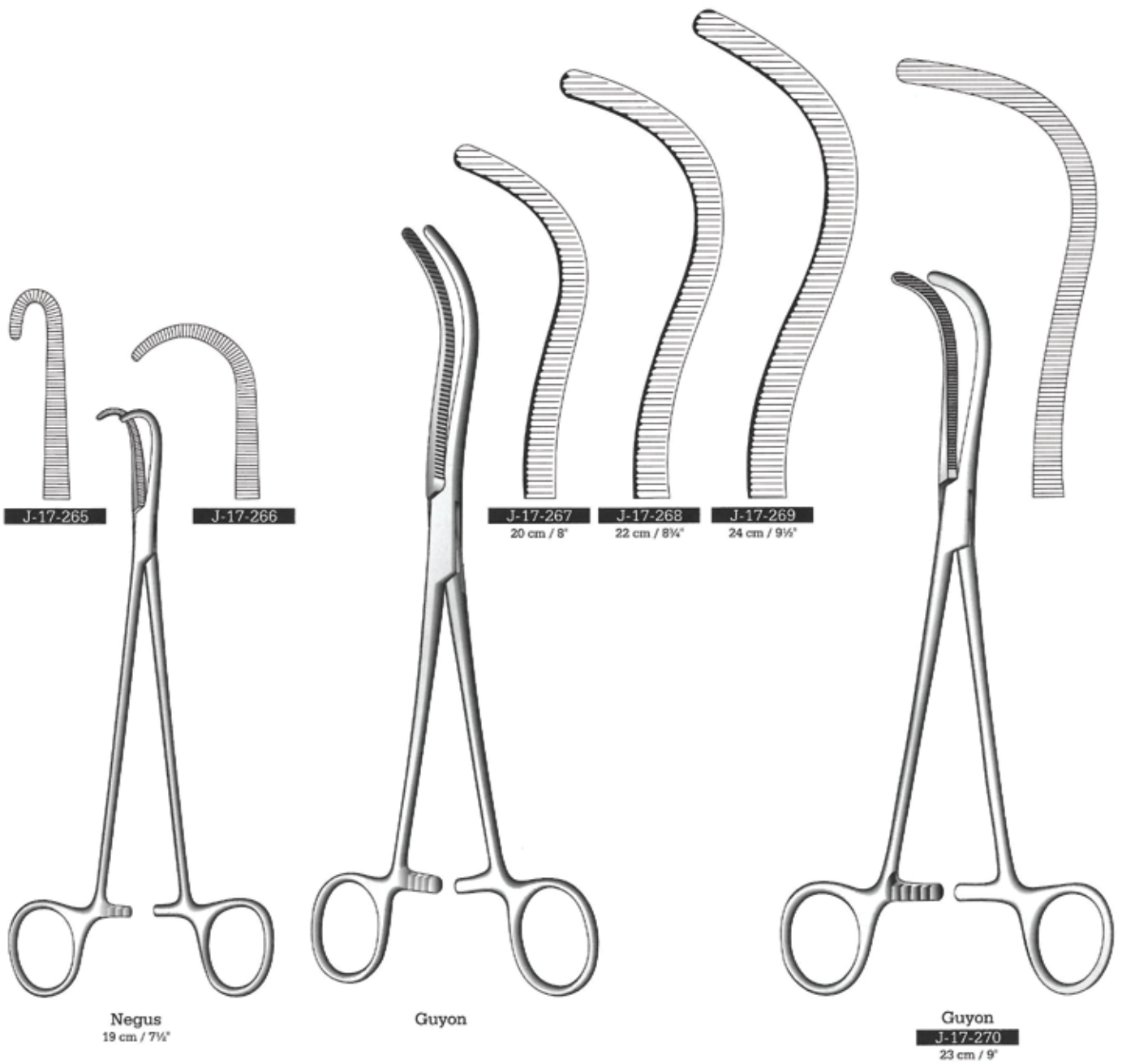

Artery Forceps

Kidney Pedicle Clamp Forceps

Nierenstieklemmen

Pinzas-Clamps Para Pedunculos Renales



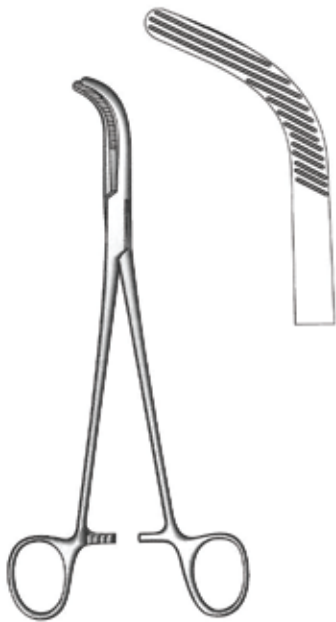

Crile
J-17-275
 20 cm / 8"



Gray

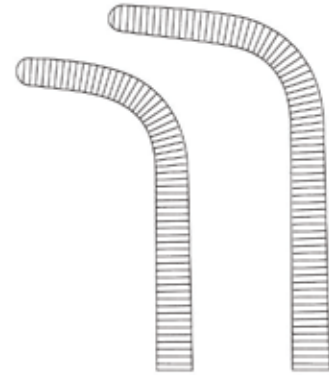

J-17-276
 22 cm / 8 3/4"

J-17-277
 23 cm / 9"



Gray

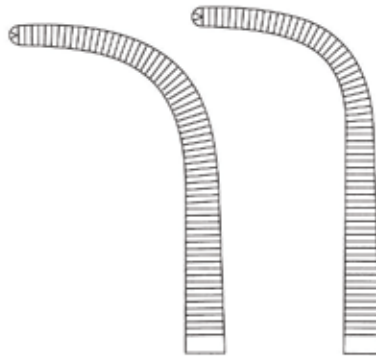

J-17-278
 22 cm / 8 3/4"

J-17-279
 23 cm / 9"



Dean-Shallcross
J-17-280
 18 cm / 7"

Artery Forceps

Gall Duct peritoneal clamp forceps

Gallenkanaklemmen, Peritoneumklemmen

Pinzas para conducto biliar, Pinzas-Clamps Para Peritoneo

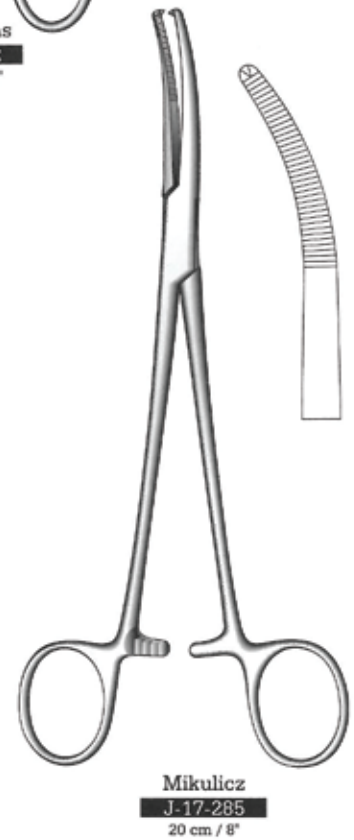
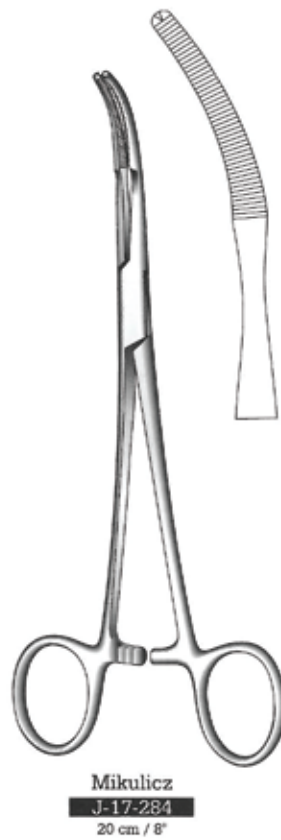
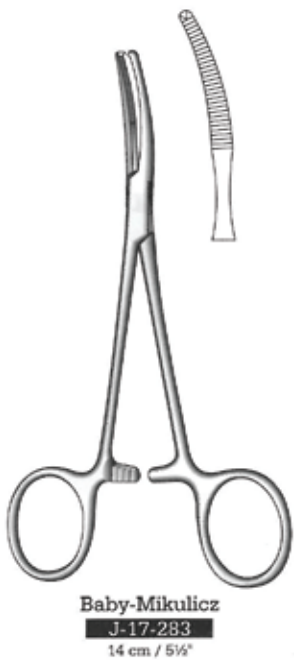

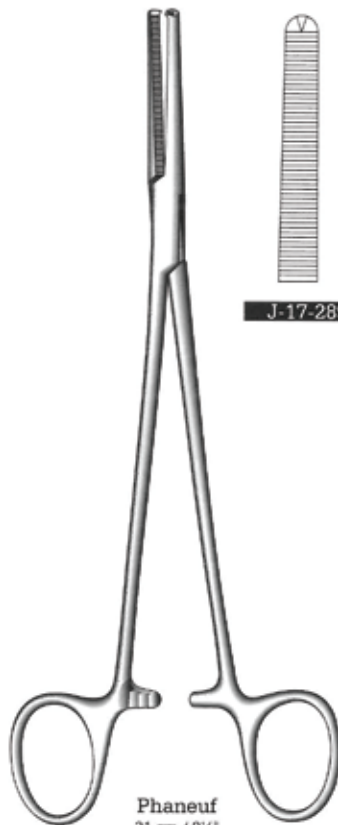

Phaneuf
 21 cm / 8 1/2"
 1:2 Teeth



J-17-289

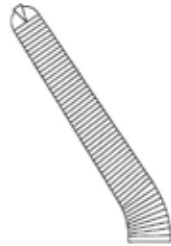

J-17-290



Faure
 20 cm / 8"
 1:2 Teeth



J-17-291

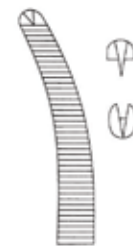

J-17-292



Wertheim
 1:2 Teeth



J-17-293
 22 cm / 8 3/4"
 Slightly curved



J-17-294
 23 cm / 9"
 More curved

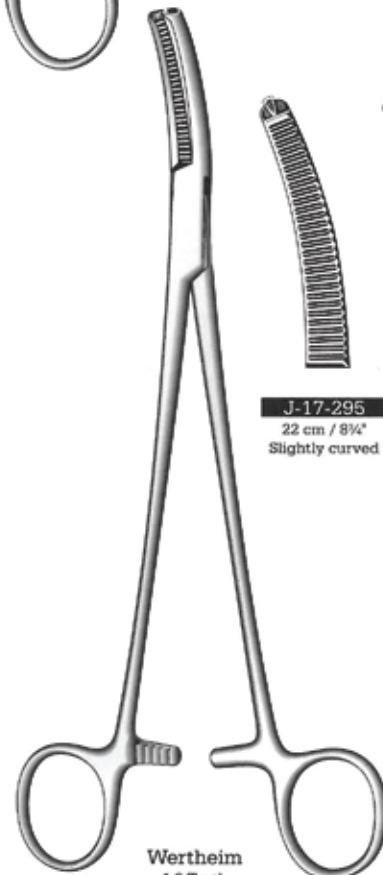

Wertheim
 1:2 Teeth



J-17-295
 22 cm / 8 3/4"
 Slightly curved



J-17-296
 23 cm / 9"
 More curved

Artery Forceps

Hysterectomy & Vaginal Clamp Forceps

Hysterektomieklemmen, Vaginalklemmen

Pinzas-clamps para histerectomia y vaginales

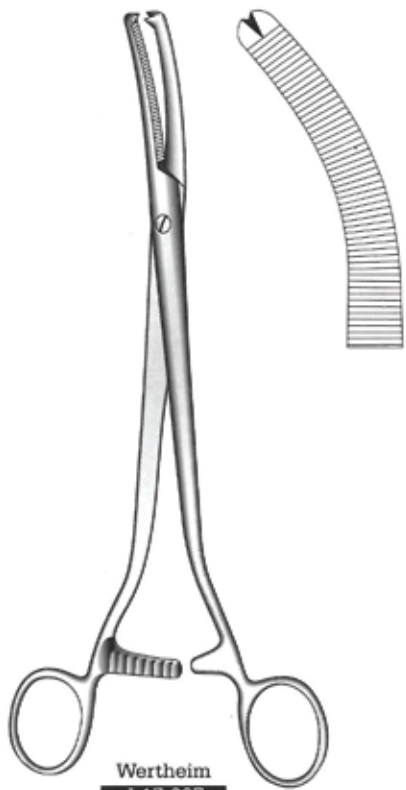

Werheim
J-17-297
24 cm / 9 1/2"
Extra strong



Werheim
J-17-298
25 cm / 10"

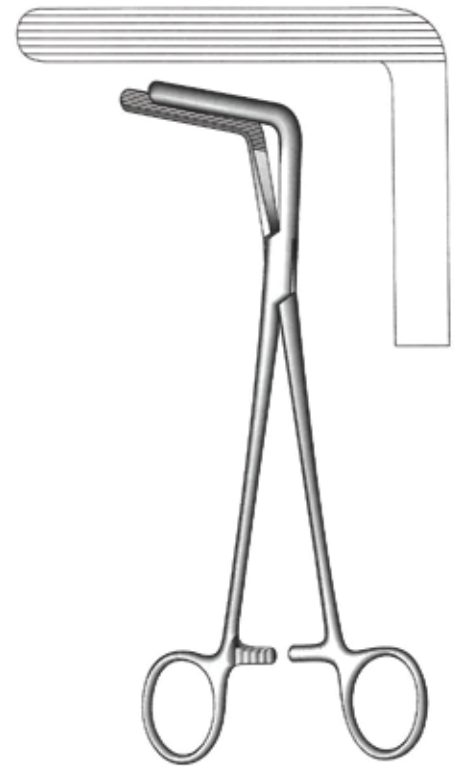

Werheim Cullen
J-17-299
21.5 cm / 8 1/2"



Moynihan

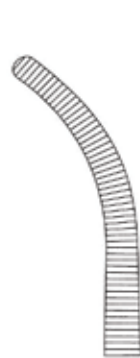

J-17-300
23 cm / 9"

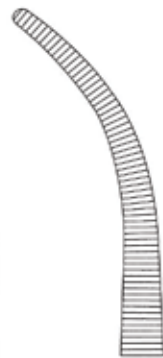

J-17-301
24 cm / 9 1/2"



Maingot



J-17-302
20.5 cm / 8"



J-17-303
25 cm / 10"

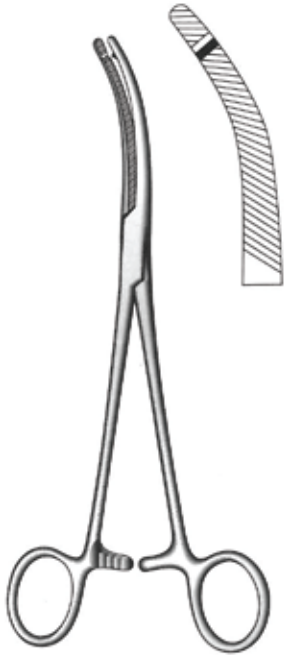

Heaney
J-17-780 19 cm / 7½"
J-17-781 21 cm / 8¼"
J-17-782 24.5 cm / 9¾"
 Hysterectomy forceps
 Heavy pattern, single tooth
 Curved

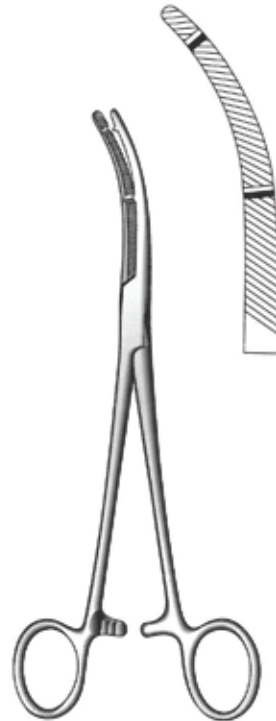

Heaney
J-17-785 19 cm / 7½"
J-17-786 21 cm / 8¼"
 Heavy pattern
J-17-787 24.5 cm / 9¾"
 Extra heavy pattern
 Hysterectomy forceps
 double tooth, curved

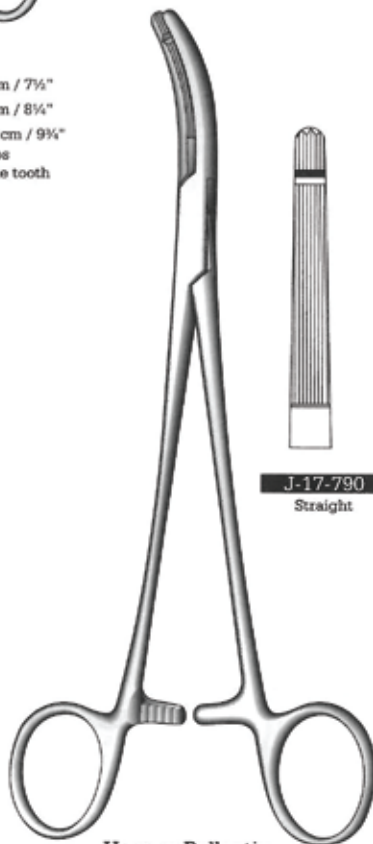

Heaney-Ballentine
 21 cm / 8¼"
 Longitudinal serrations, single tooth

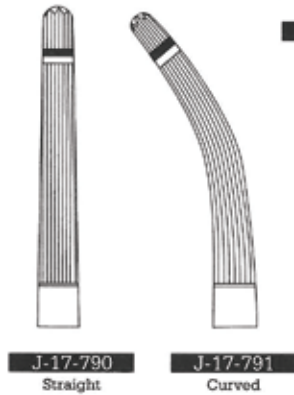

Ballentine
J-17-795
Garland
J-17-796
 21 cm / 8¼"
 Longitudinal serrations,
 single tooth, angled on flat

Artery Forceps

Hysterectomy & Vaginal Clamp Forceps

Hysterektomieklemmen, Vaginalklemmen

Pinzas-clamps para histerectomia y vaginales



ATRAUMA

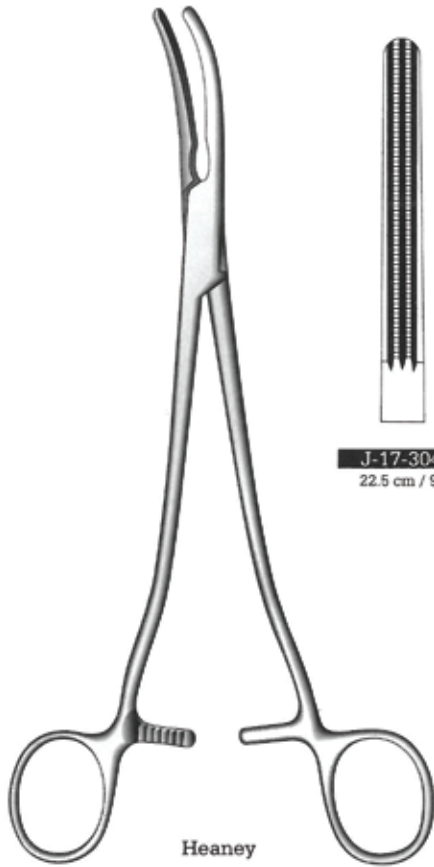

Heaney

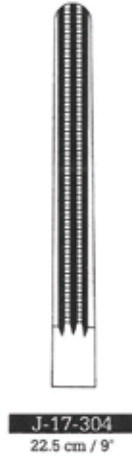

J-17-304
22.5 cm / 9"



J-17-305
21.5 cm / 8½"

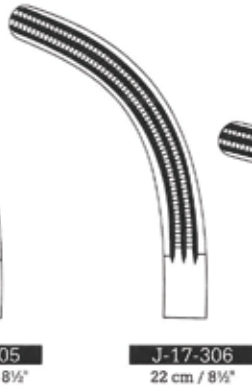

J-17-306
22 cm / 8½"

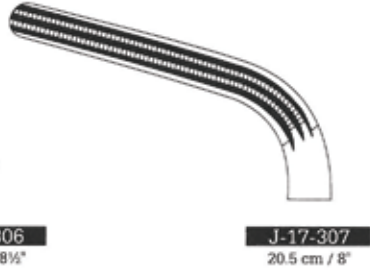

J-17-307
20.5 cm / 8"

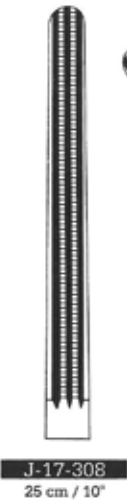

J-17-308
25 cm / 10"



J-17-309
24.5 cm / 9¾"



J-17-310
24 cm / 9½"

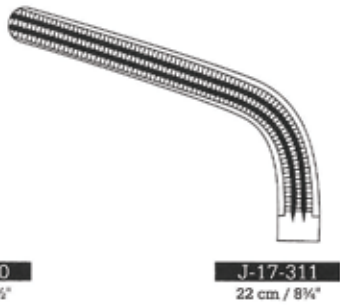

J-17-311
22 cm / 8¾"

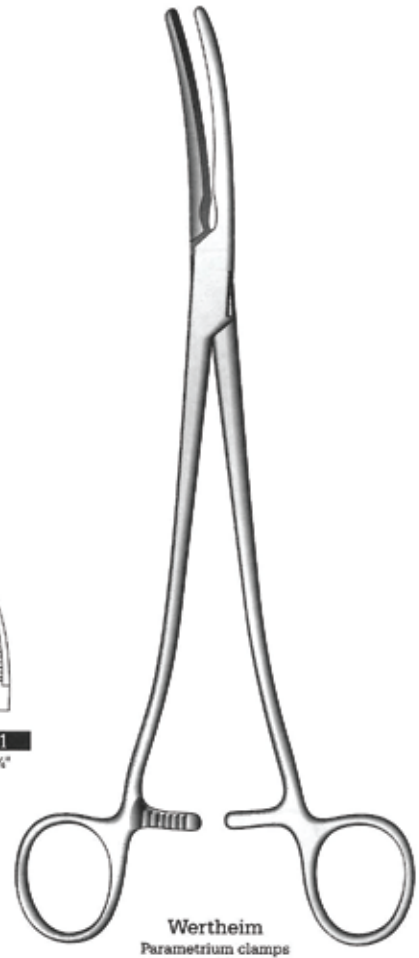

Wertheim
Parametrium clamps

ATRAUMA

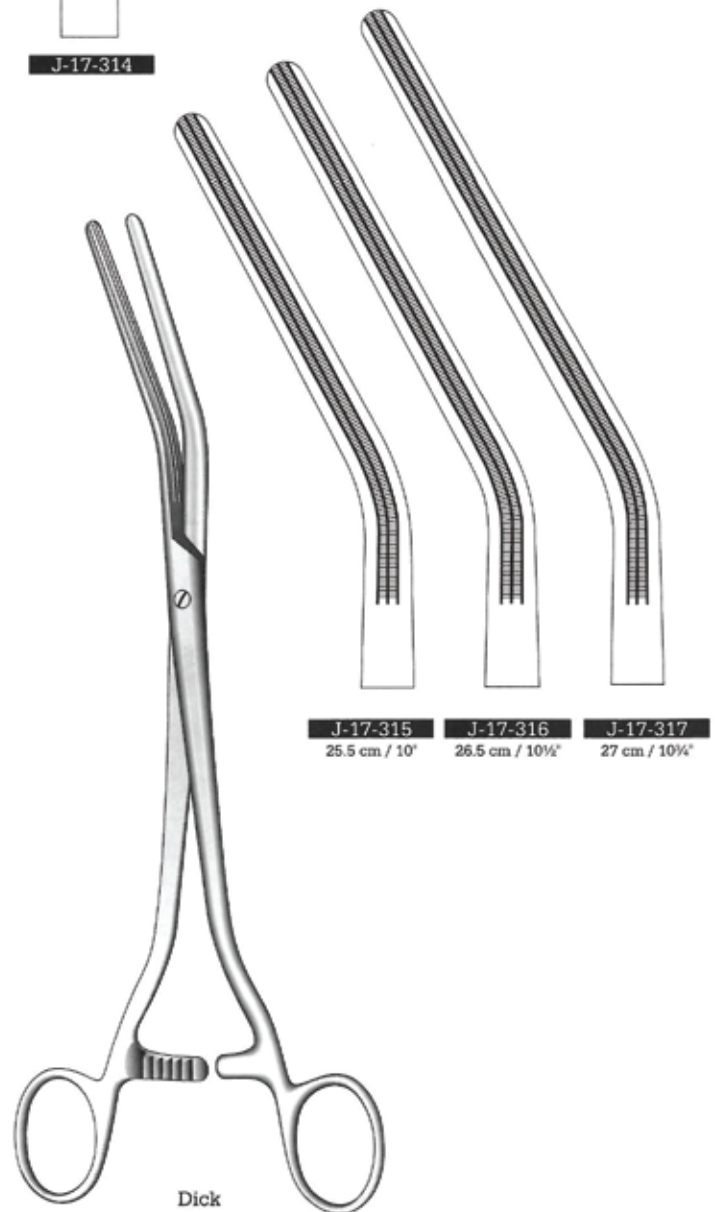
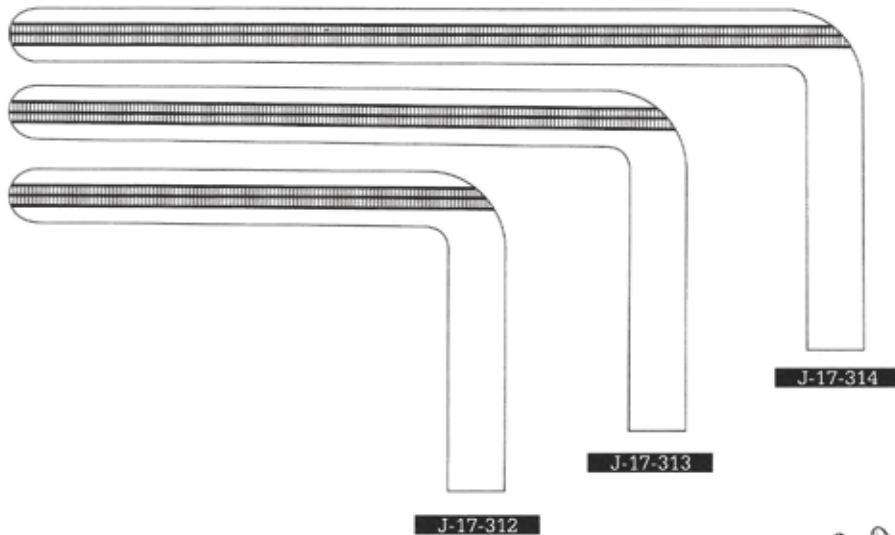

Artery Forceps

Towel Forceps

Tuchklemmen

Pinzas para compresas, Pinzas de campo



Jones

J-18-001

5 cm / 2"

J-18-002

9 cm / 3½"



Schaedel

J-18-003

9 cm / 3½"



English Model

J-18-004

9 cm / 3½"

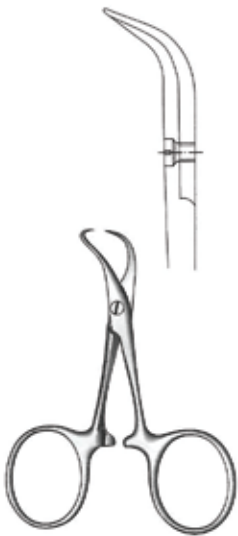

Backhaus-Kocher

J-18-005

9 cm / 3½"

J-18-006

11 cm / 4¼"

J-18-007

13 cm / 5"

Screw Joint

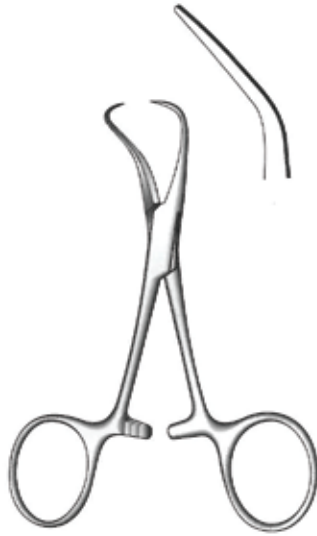

Backhaus

J-18-008

9 cm / 3½"

J-18-009

11 cm / 4¼"

J-18-010

13 cm / 5¼"

J-18-011

15 cm / 6"

Box Joint

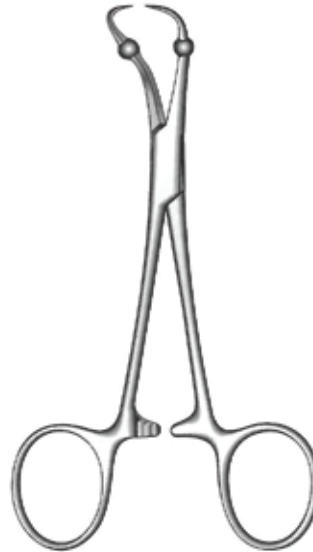

Roeder

J-18-012

11 cm / 4¼"

J-18-512

13 cm / 5¼"

J-18-013

15 cm / 6"

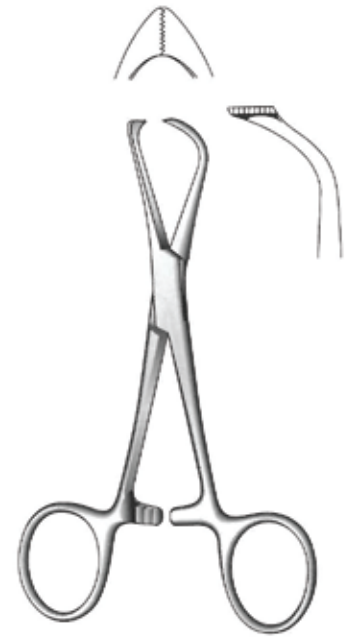

Lorna

J-18-014

10 cm / 4"

J-18-015

13 cm / 5"

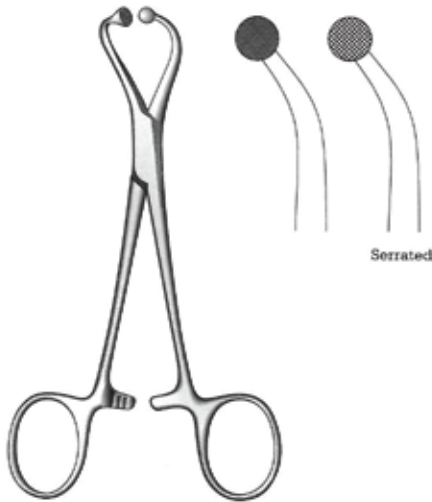

Ball-Socket
J-18-016 11 cm / 4½"
J-18-516 14 cm / 5½"
 For paper cloths
J-18-517 11 cm / 4½"
J-18-518 14 cm / 5½"
 Serrated

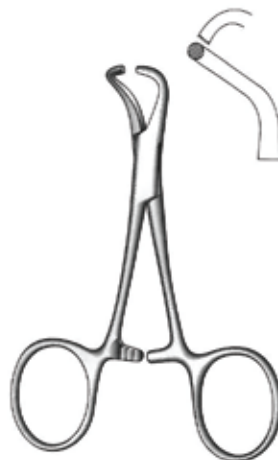

Tohoku
J-18-017 10 cm / 4"
J-18-018 13 cm / 5¼"

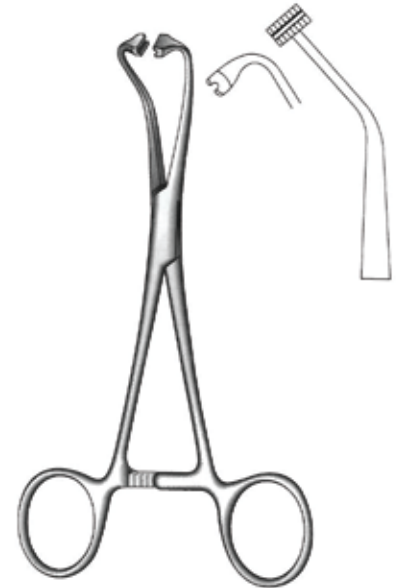

Peer's-Bertram
J-18-019
 15 cm / 6"
 For paper cloths



Bernhard
J-18-020
 18.5 cm / 6½"

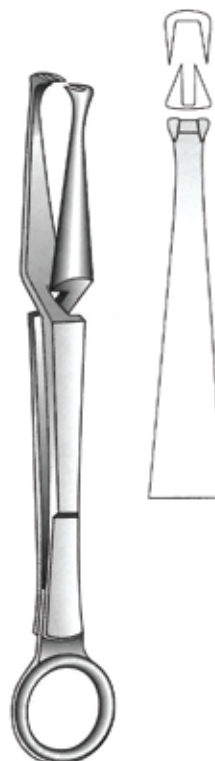

Doyen
J-18-021
 18 cm / 7"

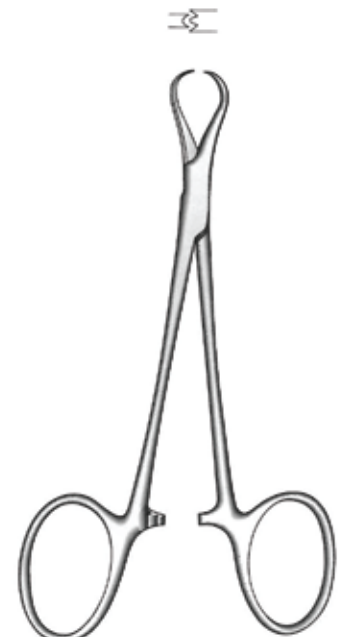

Jayle
J-18-140
 13 cm / 5"

Tubing Clamps

Tubing Clamps
Schlauchklemmen
Pinzas para tubos

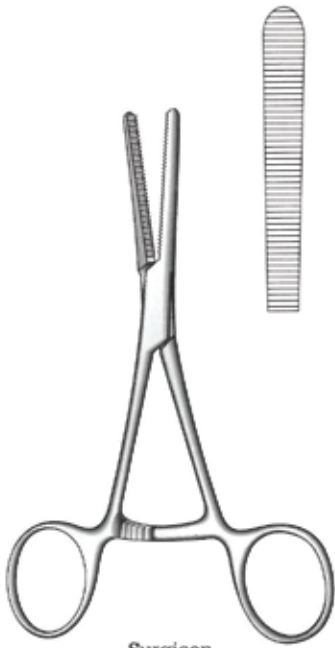

Surgicon
J-18-022
14.5 cm / 5 7/8"
With extra long ratchet

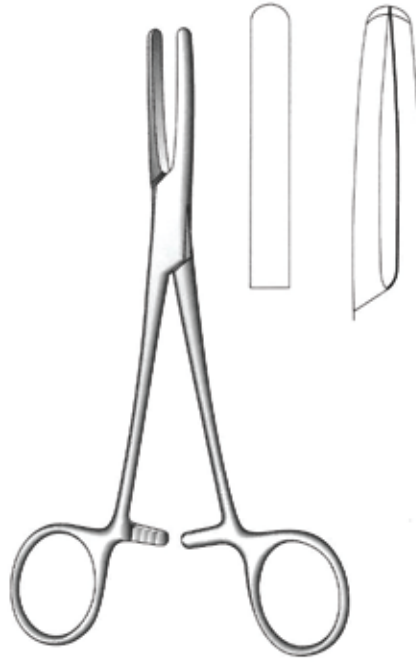

J-18-023 14.5 cm / 5 7/8"
J-18-024 16 cm / 6 1/4"
J-18-025 18 cm / 7"



J-18-100
With stainless steel rollers
J-18-110
With teflon rollers
16 cm / 6 1/4"

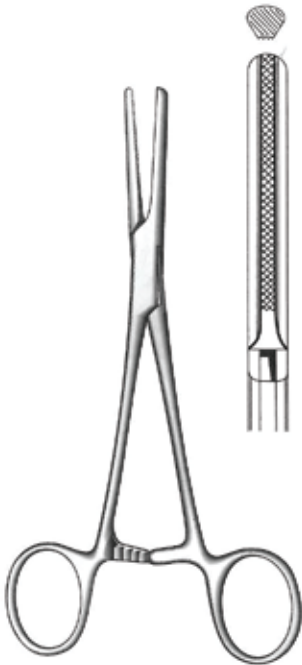

Standard
J-18-150 14 cm / 5 1/2"
J-18-026 15 cm / 6"
J-18-027 18 cm / 7"
J-18-028 20 cm / 8"

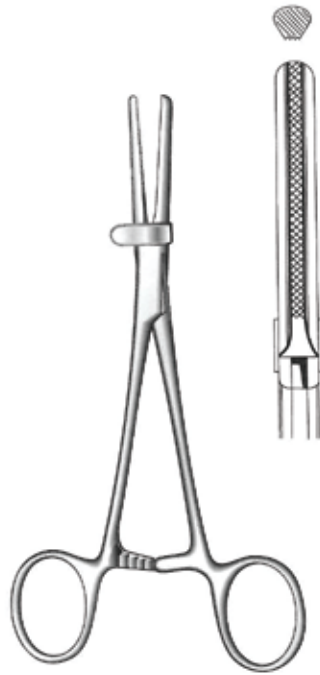

J-18-160 14 cm / 5 1/2", with guard
J-18-029 15 cm / 6"
J-18-030 18 cm / 7"
J-18-031 20 cm / 8"



Gunnar
J-18-120
With stainless steel rollers
J-18-121
With teflon rollers
18.5 cm / 7 1/4"

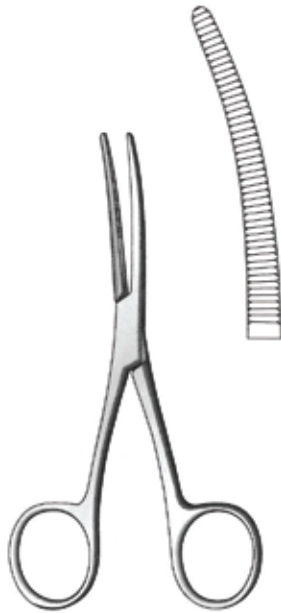

Bryant
J-18-032 Box joint
J-18-540 Screw joint
 13 cm / 5 1/4"

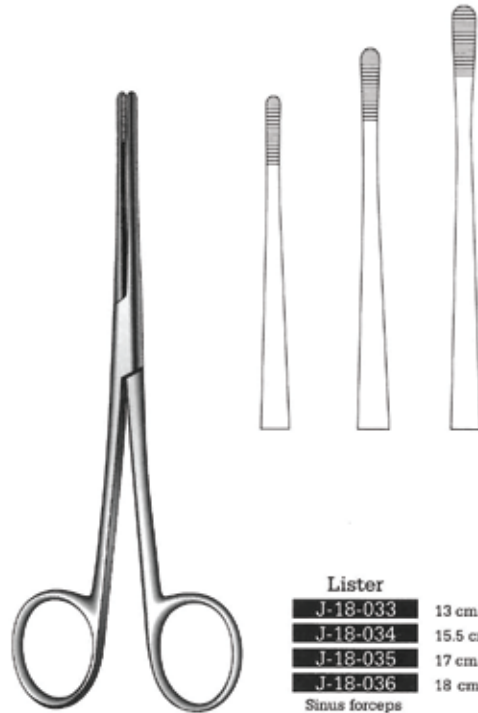

Lister
J-18-033 13 cm / 5"
J-18-034 15.5 cm / 6"
J-18-035 17 cm / 6 3/4"
J-18-036 18 cm / 7"
 Sinus forceps

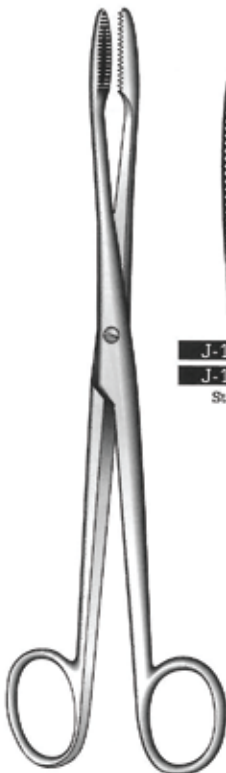

J-18-037 18 cm / 7"
J-18-038 20 cm / 8"
 Straight

J-18-039
J-18-040
 Curved

Gross-Maier

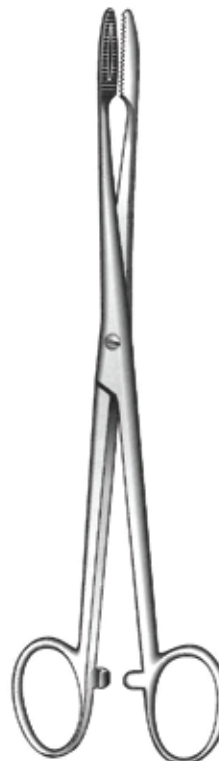

J-18-041 18 cm / 7"
J-18-042 20 cm / 8"
 Straight

J-18-043
J-18-044
 Curved

Gross-Maier

Artery Forceps

Polypus, Dressing and Cotton Swab Forceps

Korn-(Polypen-)Zengen, Tupferzangen

Pinzas para polipos Y vendajes, Pinzas para tapones

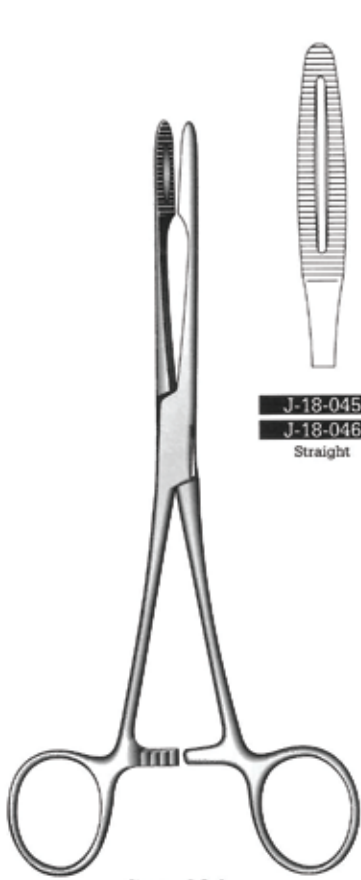

Gross-Maier

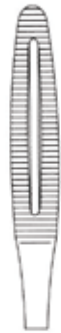

J-18-045
J-18-046
Straight

20 cm / 8"
25 cm / 10"

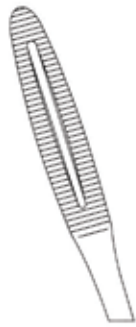

J-18-047
J-18-048
Curved



Maier
Without ratchet



J-18-049
J-18-530
J-18-531
Straight



J-18-050
J-18-535
J-18-536
Curved

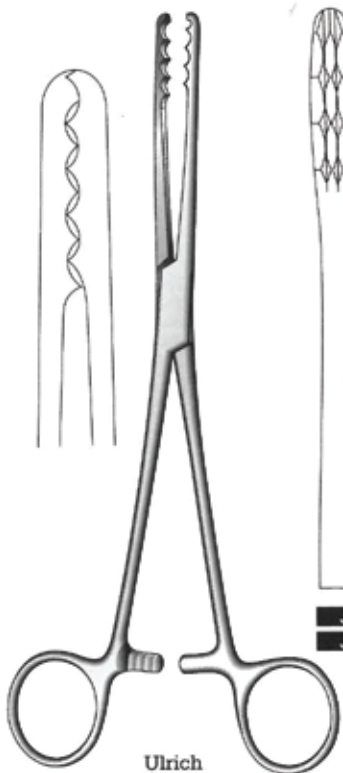

Ulrich



J-18-051
J-18-052
Straight



J-18-053
J-18-054
Curved



Sims-Maier
28 cm / 11"



J-18-055
Straight



J-18-056
Curved

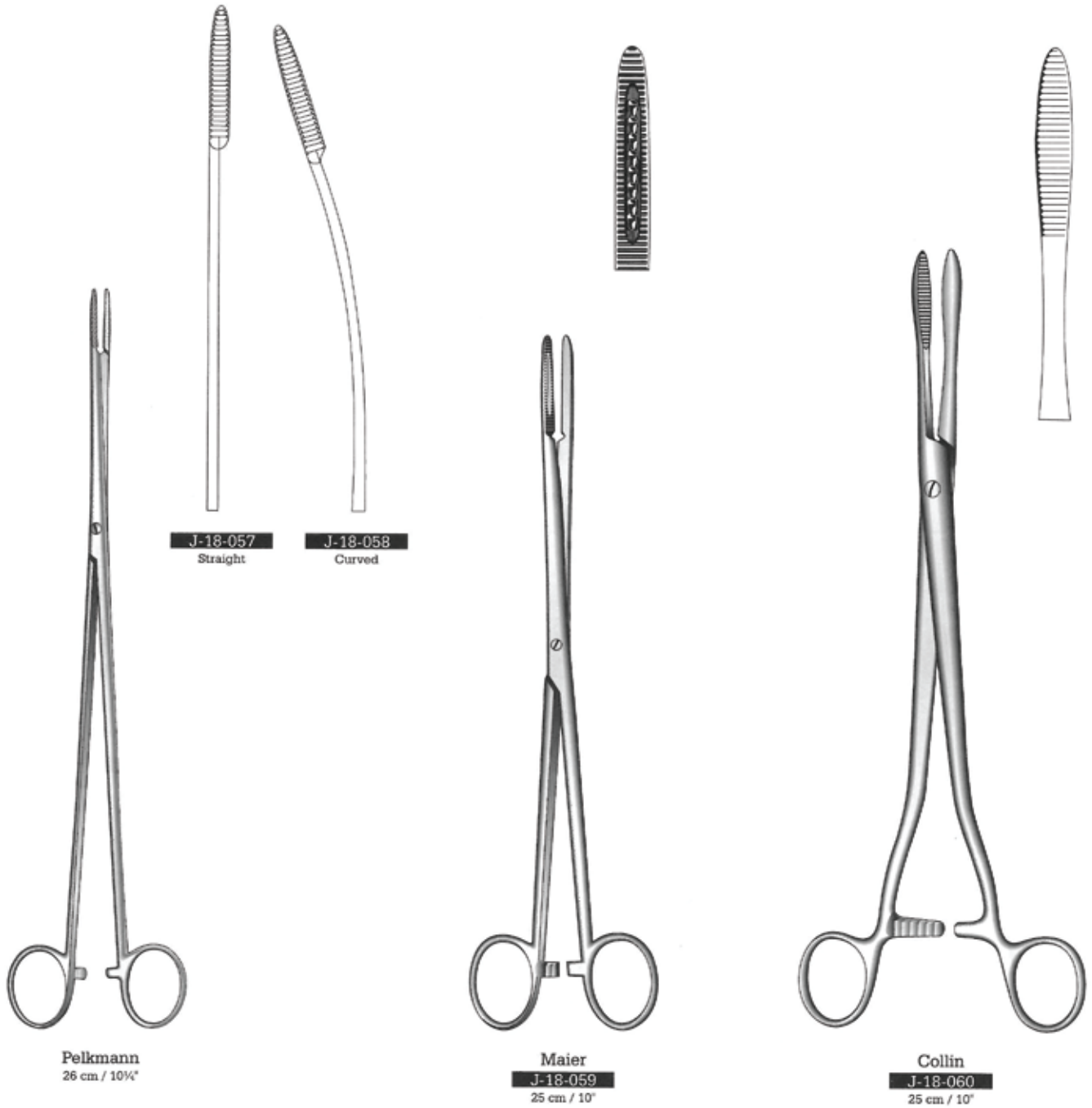

Artery Forceps

Dressing Forceps, Sponge Forceps

Kornzangen, Schwammzangen

Pinzas para vendajes, Pinzas para tapones



Cheron
J-18-061
25 cm / 10"

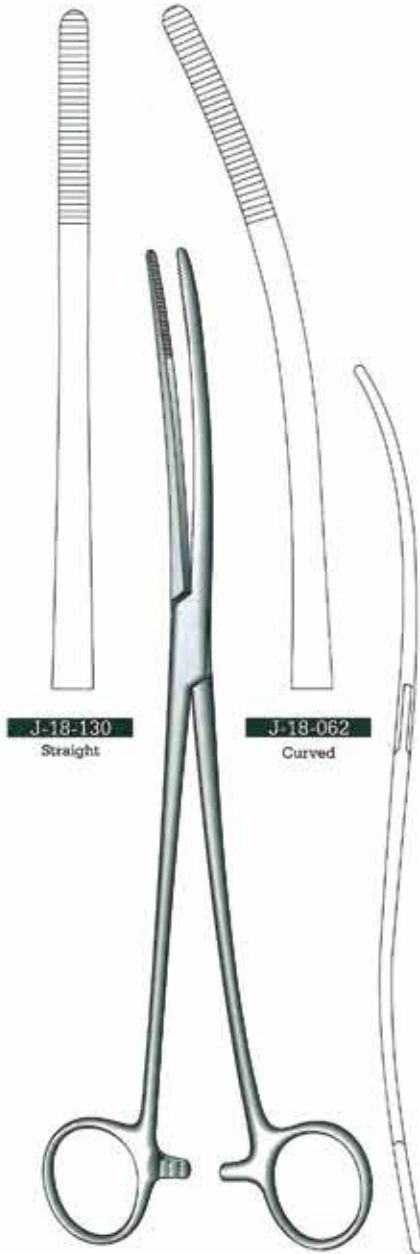

J-18-130
Straight

J-18-062
Curved

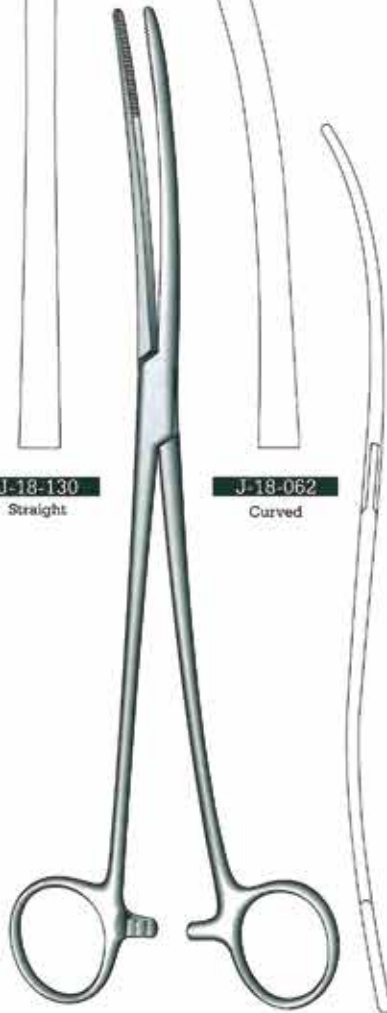

Bozemann
26 cm / 10 1/4"



Cheron
J-18-063
24 cm / 9 1/2"
Handles laterally angled

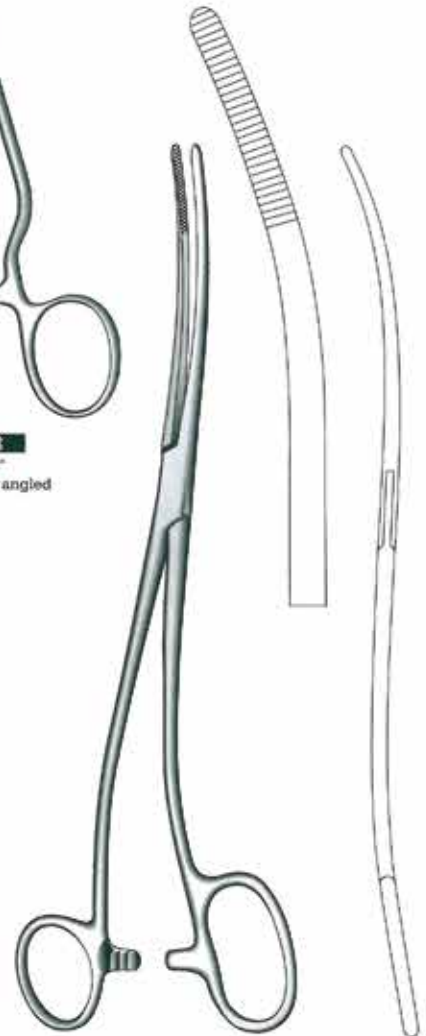

Bozemann-Douglas
J-18-064
26 cm / 10 1/4"
One ring large

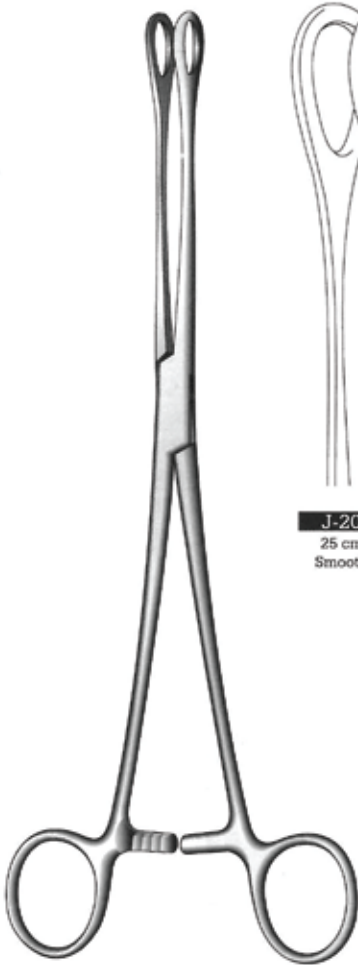

Foerster



J-20-761
 25 cm / 10"
 Smooth jaws



J-20-762 18 cm / 7"
J-20-763 20 cm / 8"
J-20-764 25 cm / 10"



J-20-765
 25 cm / 10"
 Smooth jaws

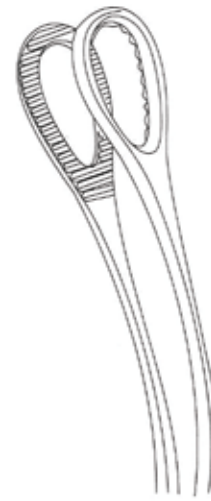

J-20-766 18 cm / 7"
J-20-767 20 cm / 8"
J-20-768 25 cm / 10"



Rampley

J-18-073 18 cm / 7"
J-18-074 25 cm / 10"



Rampley

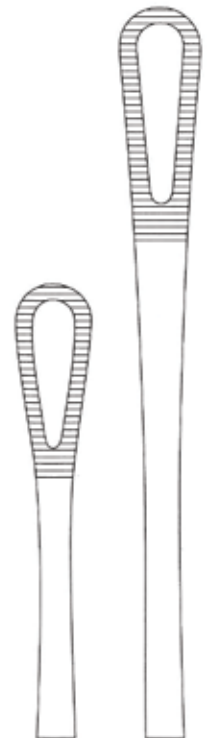

J-20-469 18 cm / 7"
J-20-470 25 cm / 10"
 Box lock

J-20-769 18 cm / 7"
J-20-770 25 cm / 10"
 Screw lock